

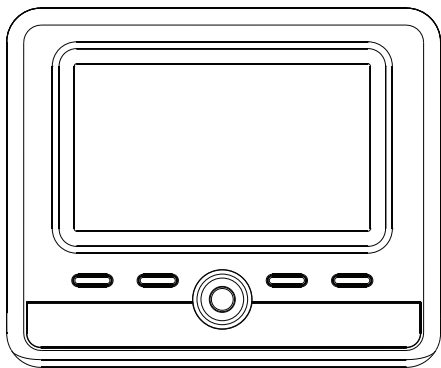

user **manual**
manual de usuario

DFL710
DFL710PK



It is important to read this user manual prior to using your new product for the first time.



Es importante leer este manual antes de usar por vez primera su equipo.

Important Safety Instructions

IMPORTANT SAFETY INSTRUCTIONS

EN

PLEASE READ AND SAVE FOR FUTURE REFERENCE

 <p>THE LIGHTNING FLASH AND ARROWHEAD WITHIN THE TRIANGLE IS A WARNING SIGN ALERTING YOU OF "DANGEROUS VOLTAGE" INSIDE THE PRODUCT.</p>	CAUTION RISK OF ELECTRIC SHOCK DO NOT OPEN	 <p>THE EXCLAMATION POINT WITHIN THE TRIANGLE IS A WARNING SIGN ALERTING YOU OF IMPORTANT INSTRUCTIONS ACCOMPANYING THE PRODUCT.</p>
SEE MARKING ON BOTTOM / BACK OF PRODUCT		

WARNING: TO PREVENT FIRE OR ELECTRICAL SHOCK HAZARD, DO NOT EXPOSE THIS PRODUCT TO RAIN OR MOISTURE.

IMPORTANT SAFETY NOTICE: It is unlawful in most jurisdictions for a person to drive a motor vehicle which is equipped with a television viewer or screen that is located in the motor vehicle at any point forward of the back of the driver's seat, or that is visible, directly or indirectly, to the driver while operating the vehicle. This product should ONLY be installed to the rear of the back of the back of the driver's seat where it will not be visible, directly or indirectly, to the operator of the motor vehicle. In addition, the state of Rhode Island forbids the installation of such a device in a motor vehicle.

Some of the following information may not apply to your particular product; however, as with any electronic product, precautions should be observed during handling and use.

- Read all instructions prior to use.
- Keep these instructions.
- Heed all warnings.
- Follow all instructions.
- Do not use the DVD player near water.
- Clean only with dry cloth.
- Do not install near any heat sources such as radiators, heat registers, stoves, or other apparatus (including amplifiers) that produce heat.
- Do not defeat the safety purpose of the polarized or grounding-type plug. A polarized plug has two blades with one wider than the other. A grounding type plug has two blades and a third grounding prong. The wide blade or the third prong is provided for your safety. If the provided plug does not fit into your outlet, consult an electrician for replacement of the obsolete outlet.
- Protect the power cord from being walked on or pinched particularly at plugs, convenience receptacles, and the point where they exit from the DVD player.
- Only use attachments/accessories specified by the manufacturer.



- Use only with the cart, stand, tripod, bracket, or table specified by the manufacturer, or sold with the apparatus. When a cart is used, use caution when moving the cart/apparatus combination to avoid injury from tip-over.
- Unplug the DVD player during lightning storms or when unused for long periods of time.
- Refer all servicing to qualified service personnel. Servicing is required when the DVD player has been damaged in any way, such as power-supply cord or plug is damaged, liquid has been spilled or objects have fallen into the DVD player, the DVD player has been exposed to rain or moisture, does not operate normally, or has been dropped.



Portable Cart Warning

Additional Safety Information

- The DVD player shall not be exposed to dripping or splashing, and objects filled with liquids, such as vases, shall be placed on the DVD player.
- Always leave sufficient space around the product for ventilation. Do not place product in or on a bed, rug, in a bookcase or cabinet that may prevent air flow through vent openings.
- Do not place lighted candles, cigarettes, cigars, etc., on the product.
- Connect power cord only to AC power source as marked on the product.
- Care should be taken so that objects do not fall into the product.
- Do not attempt to disassemble the DVD player. This product does not contain customer serviceable components.
- Do not use the unit immediately after transportation from a cold place to a warm place; condensation problems may result. Wait for about one hour till the moisture evaporates before operating the unit.
- When using your portable DVD player, do not sit or stand too close to the screen.
- To use a headset safely, please keep the following in mind:
 - Do not play your headset at a high volume. Hearing experts advise against continuous extended play.
 - If you experience ringing in your ears, turn down the volume or stop using the headset.
 - Do not use a headset while driving a motorized vehicle or riding a bike. It may cause a traffic hazard and is illegal in many areas.
 - Even if your headset is an open-air type designed to let you hear outside sounds, don't turn up the volume so high that you can't hear sounds around you.
- CAUTION! CD and DVD products utilize a laser. Do not try to open the product. Refer all servicing to qualified service personnel.
- CAUTION! Danger of explosion if battery is incorrectly replaced. Replace only with the same or equivalent type.
- Warning: Your DVD player contains a battery and charging system which is designed to work in temperatures that do not exceed 50°C (122°F). Leaving this product in a closed automobile or in the trunk of an automobile where temperature may exceed 50°C may result in permanent battery damage, fire, or explosion. Please remove your product from the automobile when you exit, do not place your product in the trunk of your automobile, and do not leave your product in any location where temperature may exceed 50°C.



FCC Information

EN

This device complies with part 15 of the FCC rules. Operation is subject to the following two conditions: (1) This device may not cause harmful interference, and (2) This device must accept any interference received, including interference which may cause undesired operation.

This equipment has been tested and found to comply with the limits for a Class B digital device, pursuant to Part 15 of the FCC Rules. These limits are designed to provide reasonable protection against harmful interference in a residential installation. This equipment generates, uses and can radiate radio frequency energy and, if not installed and used in accordance with the instructions, may cause harmful interference to radio communications. However, there is no guarantee that interference will not occur in a particular installation.

If this equipment does cause harmful interference to radio or television reception, which can be determined by turning the equipment off and on, the user is encouraged to try to correct the interference by one or more of the following measures:

- Reorient or relocate the receiving antenna.
- Increase the separation between the equipment and receiver.
- Connect the equipment into an outlet on a circuit different from that to which the receiver is connected.
- Consult the dealer or an experienced radio / TV technician for help.

In accordance with FCC requirements, changes or modifications not expressly approved by manufacturer could void the user's authority to operate this product.

Manufacturer/Responsible Party
Audiovox Electronics Corp.,
150 Marcus Blvd., Hauppauge, NY 11788

This Class B digital apparatus complies with
Canadian ICES-003.
Cet appareil numérique de la classe B est
conforme à la norme NMB-003 du Canada.

Important information

Service Information

This product should be serviced only by those specially trained in appropriate servicing techniques. For instructions on how to obtain service, refer to the warranty included in this user manual.

For Your Records

Keep your sales receipt for proof of purchase to obtain warranty parts and service. In the event that service should be required, you may need both the model number and the serial number. In the space below, record the date and place of purchase, and the serial number:

Model No.

Date of Purchase

Place of Purchase

Serial No.

Contents

EN

Important Safety Instructions	1
--	----------

FCC Information	3
------------------------------	----------

Important information

Service Information	4
For Your Records	4

Before you begin

DVD and Disc Information	7
Unpacking the unit	8
Recharging the built-in battery	8
Powering and Installation	9
Installing the DVD player onto the seat back in a car	10

Getting started

Have you subscribed?	11
Are you within FLO TV coverage?	11
How long will the battery last?	11

General controls

Main Unit	12
Remote Control	13

Basic navigation	14
-------------------------------	-----------

Subscribing to the FLO TV Service

Power on your device	18
Activate your subscription online	18
Log on to www.flotv.com	18
Security	19

Program Guide

Access the Program Guide	20
View program descriptions	20
Change channels	21
View channel information	21

Settings

Parental Controls	22
Turn on parental controls and set your PIN	22
Set TV viewing limits	23
Restrict an entire channel	23

Turn off Parental Controls	24
Reset your PIN	24

Managing Your Account Online..... 25

DVD/CD playback

Starting playback of CD/DVD	26
Playing Audio CDs.....	26
Play Kodak Picture CD	26
DVD Playback.....	26
DVD Menu.....	27

Playback operations

Playback Time and Remaining Time	28
Subtitle.....	28
Audio	29
Zoom.....	29
Repeat	29
Angle.....	30

Playing JPEG files 31

Connecting to headphones 31

DVD settings

General setup page.....	32
Password setup page.....	34
Preference page.....	35

System Setup Page..... 38

Specifications..... 39

Troubleshooting

FLO TV.....	40
DVD Playback.....	41

Getting Help

Customer Support	43
------------------------	----



Index..... 44

Before you begin

EN

Thank you for choosing the Audiovox 7" Portable DVD Player with FLO TV™. The main features include a 7" Wide Screen (16:9 Aspect Ratio) Liquid Crystal Display (LCD) monitor and a DVD player. The unit applies the latest state of the art electronics and is designed for use in hotels, offices or your home. The unit is constructed to provide years of reliable, trouble free service and is compact so that you can take it with you anywhere and is designed for quick and easy installation. Please read the entire instruction manual supplied with this product prior to using. The documentation will assist you in using the system properly to obtain the best equipment performance. Please save this manual for later use.

DVD and Disc Information

- **DVD Copy Protection** - This Product incorporates copyright protection technology that is protected by method claims of certain U.S. Patents and other intellectual property rights owned by Macrovision Corporation and other rights owners. Use of this copyright protection technology must be authorized by Macrovision Corporation, and is intended for home and other limited viewing uses only unless otherwise authorized by Macrovision Corporation. Reverse engineering or disassembly is prohibited.
- **DVD Regional Code** - Your DVD player has been designed to process regional management information that is stored on DVD discs. The regional code for your player is 1 (The U.S., U.S. Territories and Canada). Only DVD discs that have regional codes of 1 or ALL (for all regions) can be played by your player.  
- **Disc** - Do not use irregularly shaped discs such as heart or star-shaped discs as they may cause the unit to malfunction. Do not stick paper, tape or glue on the disc. Do not expose the disc to direct sunlight or heat sources such as hot air ducts. Do not touch the surface of disc. Handle the disc by its edge. Clean the disc by wiping the disc from the center out with a cleaning cloth. Remove the disc from the unit and store it in its case after playing. Some playback operations of discs may be intentionally fixed by software producers. Since this unit plays discs according to the disc contents the software producers designed, some playback features may not be available. Also refer to the instructions supplied with the discs.

Unpacking the unit

- 1 x Audiovox 7" Portable DVD Player with FLO TV™
- 1 x Audio/Video Cable
- 1 x AC to DC Adapter
- 1 x DC Power Adapter
- 1 x Remote Control with battery (CR2025)*
- 1 x Carrying Bag*
- 2 x Foldable Headphones*
- 1 x Instruction Manual
- 1 x Quick Start Guide
- 1 x Product Registration Card
- 1 x eMusic Card
- 1 x EULA
- 1 x **FLO** Terms of Service and Software License
- 1 x **FLO** Activation Insert

* For DFL710PK only

Recharging the built-in battery

1. The DVD player utilizes a long-life Li-Polymer battery for portability. Li-Polymer batteries feature high storage capacity and low level of degradation. This means the Li-Polymer batteries do not have "Memory Effect" and thus can be recharged regardless of whether the battery is fully or only partially discharged. The battery must be charged at least 8 hours prior to first use.

If you plan to not use the battery for an extended period of time (one week or longer), we recommend that you fully charge the battery. For longer periods of storage, please recharge the battery at least once every two months to maintain the battery in optimum condition. Each full recharge takes approximately five hours.



2. Recharging battery

There are two methods to recharge the battery. Connect the AC to DC adapter to the unit, and then

- A. power off the player. The Charge/Power LED will be red. Once fully charged, the Charge/Power LED will turn off.
- B. power on the player. The Charge/Power LED will be red during charge. Once fully charged, the Charge/Power LED will be green.

During playback, an icon  appears on the screen, which means the battery has low power and you should recharge the built-in battery now.



3. **Using and Maintaining Your Rechargeable Batteries**

- A. Please make sure you always use only the AC adapter included with the player to recharge your battery. The battery can only be charged with the AC adaptor and will NOT charge with the car DC adaptor.
- B. Recharge efficiency will degrade when environmental temperatures drop below 41°F (5°C) or exceed 95°F (35°C).
- C. Do not leave the DVD player in a hot automobile or temperatures exceeding 122°F (50°C). Permanent battery damage, fire, or explosion may result.

Powering and Installation

• **Powering the system indoors**

Plug one end of the AC to DC adaptor into the DC input jack on the left side of the unit, then plug the other end into the 100~240 V AC power receptacle.

• **Powering the system in a car**

Plug one end of the DC Power adapter into the DC input jack on the unit, then plug the other end into the vehicle power outlet.

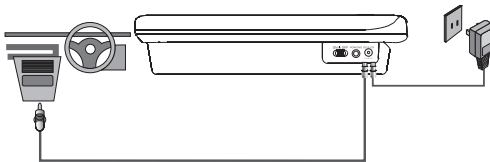

Installing the DVD player onto the seat back in a car

*For DFL710PK only

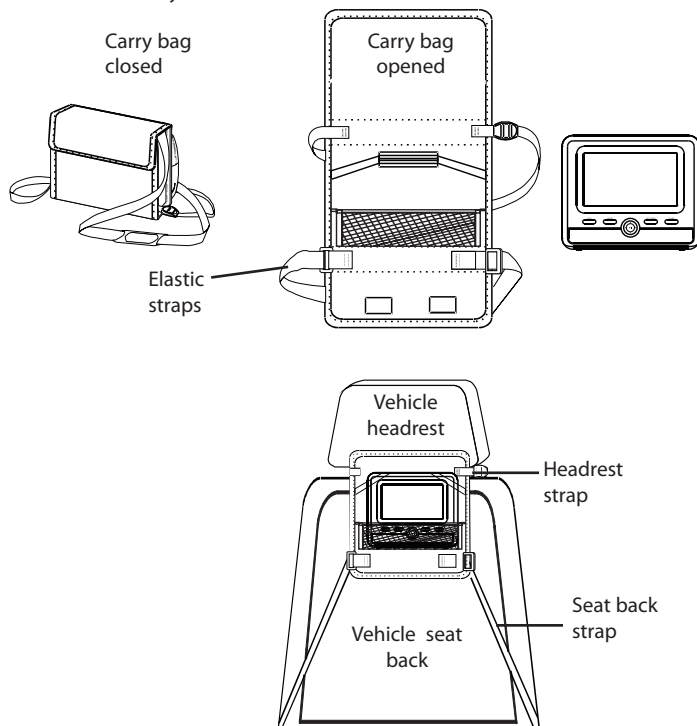

1. Unfold the carrying bag, and place the DVD player on the bag beneath the elastic straps. Ensure that the unit's corners are secured by the elastic straps.
2. Secure the upper portion of the carrying bag to headrest support bars using the headrest strap. Adjust the headrest strap until the bag is firmly secured.
3. Secure the lower portion of the carrying bag to the vehicle seat back using the seat back strap. Adjust the seat back strap until the bag is firmly secured.



Getting started

EN

If life is about the journey, yours should include a portable DVD with live mobile TV. The Audiovox 7" Portable DVD Player with FLO TV™ is the perfect travel companion. Catch live sports, breaking news, kids' programming and your favorite daytime, primetime and late night shows while on the go.

Have you subscribed?

Before you can watch mobile TV on your DVD player, you need to subscribe to the **FLO TV** service. Log on to www.flotv.com and select Activate Service. For more information on subscribing to a service plan, see [Subscribing to the FLO TV service](#).

Are you within **FLO TV** coverage?

You must be within **FLO TV** service coverage to watch the **FLO TV** service, which is available in many metropolitan areas within the United States. Please visit the **FLO TV** web site (www.flotv.com/maps) to check the coverage maps in your area.

How long will the battery last?

You can enjoy up to 3 hours of **FLO TV** programming and 2.5 hours of DVD playback before recharging the battery. The included car charger and wall charger allow for extended viewing in diverse settings. Battery life may vary depending on use.



General controls

Main Unit

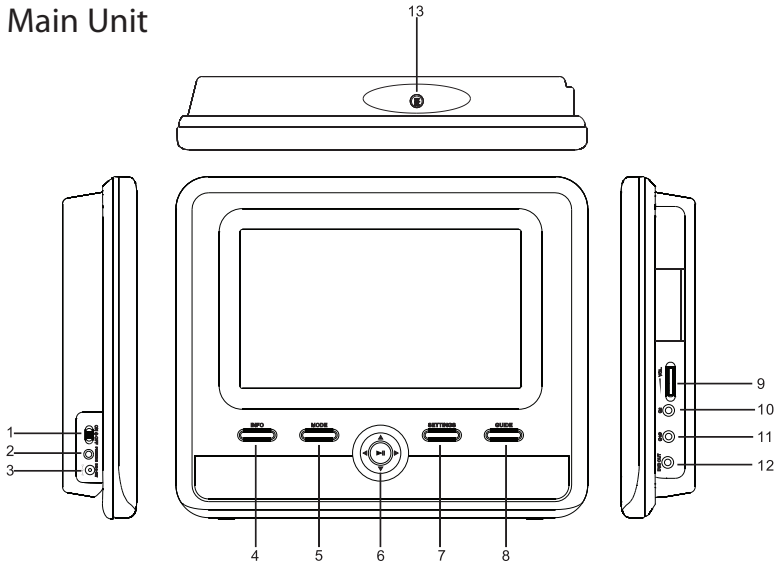

- | | |
|--|---------------------------|
| 1. Power On/Off Switch | 8. GUIDE |
| 2. Power/Charge LED | 9. Volume control |
| 3. DC9-12V Input Jack | 10. Headphone Jack 2 |
| 4. INFO | 11. Headphone Jack 1** |
| 5. MODE | 12. DVD A/V output Jack |
| 6. Navigation buttons (Up/Down/OK*/
Left/Right) | 13. DVD Cover Open Switch |
| 7. SETTINGS | |

* In DVD mode, the OK button also functions as Play/Pause, see the section "Basic navigation".

** Connecting to this headphone jack will disable the internal speakers.

Remote Control

*For DFL710PK only

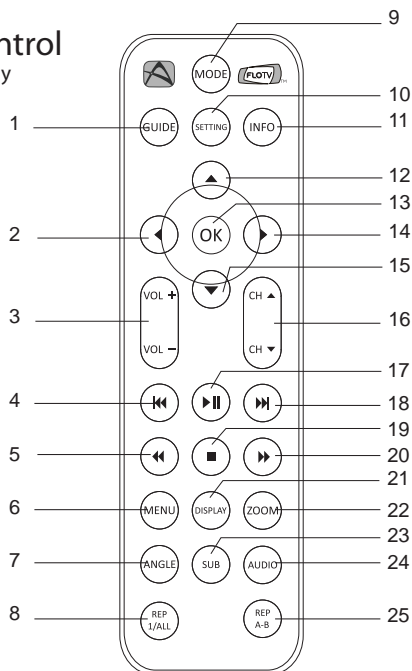

1. Guide

2. Left

3. Volume control

4. Previous

5. Fast backward scan

6. DVD Menu

7. Angle

8. Repeat 1/All

9. Mode

10. Setting

11. **FLO TV** Info

12. Up

13. OK

14. Right

15. Down

16. Channel

17. Play/Pause

18. Next

19. Stop

20. Fast forward scan

21. Display

22. Zoom

23. Subtitle











24. Audio





























25. Repeat A-B











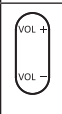

EN

Basic navigation

A few simple buttons make it easy to view the **FLO TV** service, access program information, change channels and settings, and playback CD/DVD.

Buttons on unit	Buttons on remote (For DFL710PK only)	Name	Action
		Info	<ul style="list-style-type: none"> In DVD playback mode, display the main menu of the disc.
		FLO TV Info	<ul style="list-style-type: none"> In FLO TV mode: <ul style="list-style-type: none"> View channel information and program descriptions. Press once to view the channel information bar. Press again to view the program description. Press again to close information screens.
		Mode	<ul style="list-style-type: none"> Switch between DVD player and the FLO TV service.
		Settings	<ul style="list-style-type: none"> In FLO TV mode: <ul style="list-style-type: none"> Press once to view Settings menu to set Parental Controls and get information about your subscription and the device. Press and hold for about two seconds to enter the System Setup Page. In DVD playback mode: <ul style="list-style-type: none"> Press once to enter the General Setup Page. Press again to exit the page. Press and hold for about two seconds to enter the System Setup Page.
		Guide	<ul style="list-style-type: none"> In FLO TV mode, view or close the Program Guide.
		Play/ Pause	<ul style="list-style-type: none"> Play: Start Playback. Pause: Pause at the present playing point while playback.

		STOP	<ul style="list-style-type: none"> Press  (on remote control) or press and hold  to stop playing the disc.
		OK	<ul style="list-style-type: none"> Select an item on the screen. View or close channel information.
		Up	<ul style="list-style-type: none"> Navigate menus and guide and move the highlight up the screen.
		Up	<ul style="list-style-type: none"> In FLO TV mode, change channels.
		Down	<ul style="list-style-type: none"> Navigate menus and guide and move the highlight down the screen.
		Down	<ul style="list-style-type: none"> In FLO TV mode, change channels.
		Left	<ul style="list-style-type: none"> Navigate menus and guide, move the highlight to the left and back to the previous screen. Press and hold to speed Left and Back.
		Previous	<ul style="list-style-type: none"> While playing from DVD, press and hold  (on the unit) about 2 seconds or press  (on remote control) to go back to the previous chapter, track, or scene.
		Fast backward scan	<ul style="list-style-type: none"> Fast backward: While playing from DVD, scan backward at 2x, 4x, 8x, 16x or 32x. The playback speed will return to normal when the DVD is playing back at 32x.
		Right	<ul style="list-style-type: none"> Navigate menus and guide, move the highlight to the right and move to the next screen.
		Next	<ul style="list-style-type: none"> While playing from DVD, press and hold  (on the unit) about 2 seconds or press  (on remote control) to go to the next chapter, track, or scene.

		Fast forward Scan	<ul style="list-style-type: none"> Fast forward: While playing from DVD, scan forward at 2x, 4x, 8x, 16x or 32x. The playback speed will return to normal when the DVD is playing back at 32x.
		DVD Cover Open Switch	<ul style="list-style-type: none"> Open the DVD tray by pushing the Open switch in and then swing the LCD screen open from the base.
 VOL.		Volume control	<ul style="list-style-type: none"> Adjusts the volume output up/down with numeric control.
		Menu	<ul style="list-style-type: none"> In DVD mode, press to display the DVD main menu.
		Display	<ul style="list-style-type: none"> In DVD mode, press to display the disc information includes title elapsed, title remain, chapter elapsed and chapter remain.
		Zoom	<ul style="list-style-type: none"> In DVD mode, press to zoom at 2x, 3x and 4x.
		Angle	<ul style="list-style-type: none"> In DVD mode, press to switch angle.
		Sub	<ul style="list-style-type: none"> In DVD mode, press to select subtitles.
		Audio	<ul style="list-style-type: none"> In DVD mode, press to select audio.
		Repeat 1 / All	<ul style="list-style-type: none"> In DVD mode, press repeatedly to select repeat Chapter, Title or All.
		Repeat A-B	<ul style="list-style-type: none"> In DVD mode, press to repeat a sequence between points A and B.
Headset Jack 1 and 2			<ul style="list-style-type: none"> There are two headset jacks. Connecting to Jack 1 will disable the internal speakers.
DVD output Jack			<ul style="list-style-type: none"> A/V out of DVD, disabled for FLO TV.

Power ON/OFF	<ul style="list-style-type: none">• Slide the switch to turn the unit on/off
Power/Charge LED	<ul style="list-style-type: none">• The green LED will indicate power and the red LED will indicated charging status.
DC In Jack	<ul style="list-style-type: none">• DC 9-12 V Input.

EN

Subscribing to the **FLO TV** Service

To subscribe to the **FLO TV** service, your device will need to be powered on and you need to be within a **FLO TV** coverage area. **FLO TV** coverage maps can be found at www.flotv.com/maps.

Power on your device

1. Press the Power switch on the left side of the device.
2. Press the **MODE** button to switch from the DVD player to the **FLO TV** service.
3. The **FLO TV** Preview Channel will appear shortly. If you don't see the **FLO TV** Preview Channel, you are not in coverage. You must be within the **FLO TV** coverage area to continue with the activation process. Coverage maps are at flotv.com/maps.

Activate your subscription online

To proceed with activation, you will need the following information ready:

- Credit or Debit Card
- E-mail Address
- Device ID
- Authorization Code

To find the Device ID and Authorization Code, simply change channels up or down. The non-subscribed channel state will display your Device ID and Authorization Code.

Log on to www.flotv.com

1. Click **Activate Service**

If you do not have Microsoft Silverlight™ software, you will be prompted to download a free version of the software. After Microsoft Silverlight has downloaded, select **Click here to register your new device**.

2. Follow the prompts to enter in device information, create an account, choose a subscription package and provide payment information.

If you already have a **FLO TV** account, you may activate and subscribe the Audiovox 7" Portable DVD Player with FLO TV™ device under the same account.



3. Make sure your device is powered on, in FLO TV coverage and on a subscribed channel (depending on your subscription). Your device should start playing the FLO TV service within 10 minutes.



If your device isn't playing the **FLO TV** service or displaying channel information within 10 minutes, try powering off/on. If it still doesn't receive the **FLO TV** service, call **FLO TV** Customer Care at 888-99-FLOTV (888-993-5688).



EN

Security

Due to security reasons, if you have not viewed the **FLO TV** service for over 60 days your service will be placed on "Hold". In order to refresh your service, please call **FLO TV** Customer Care at 1-888-99-FLOTV (888-993-5688).



Program Guide

The Program Guide lists all the scheduled programs and their respective channel names, program titles, descriptions, and program times.

Access the Program Guide

You can access the **FLO TV** Program Guide by pressing the **GUIDE** button.

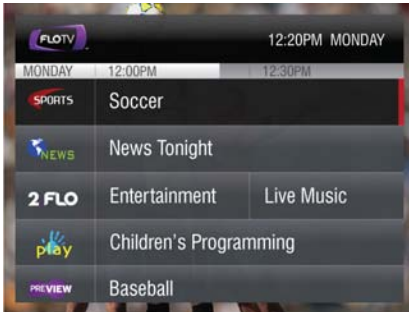

- Any programs blocked by Parental Controls show a locked icon
- You can navigate to view future program guide information for programs available in the next 7 days.
- The current program selected appears in a darker color.



View program descriptions

You can view program descriptions for current and future programs.

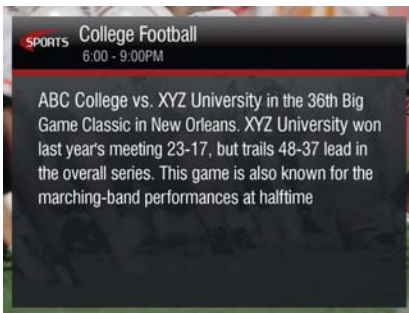



If you are viewing the Program Guide:

1. First select a current or future program in the **FLO TV** Program Guide.
2. Then press the  button.

If you are viewing a current program:

1. Press the **INFO** button once. Channel information displays.
2. Press the **INFO** button again to view the program description.

Change channels

Press the  or  buttons to change channels.

View channel information

While viewing a program, press the  button to see channel information.



Settings

From the Settings menu, you can access Parental Controls, Subscription Information, and System and Legal information.

Parental Controls



Parental Controls allows you to block shows according to ratings or entire channels.

Turn on parental controls and set your PIN

The steps below describe how to turn on Parental Controls and create a unique PIN.

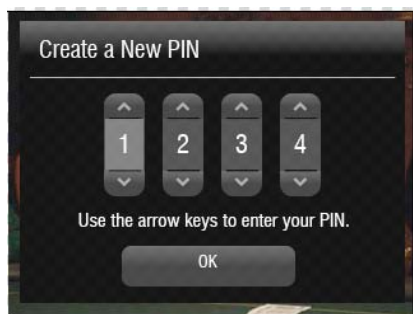
1. Select **Parental Controls** from the Settings menu and press .
2. The Create a New PIN screen appears.



3. Using the ▲ and ▼ buttons, set a 4-digit number. Keep your 4-digit PIN stored in a safe place. Once you have selected a PIN number, select OK and press .
4. The PIN is Set screen appears and Parental Controls are activated. Press the  button to continue.

The PIN is stored for only as long as the Parental Controls are enabled. Disabling Parental Controls requires a new PIN when re-enabling.



Set TV viewing limits

If you have not previously set Parental Controls, the default setting is the lowest rating available.

EN

1. Select **Parental Controls** from the Settings menu. Confirm that Parental Controls is ON.
2. Select **TV Rating Limit**.
3. Press the ▲ and ▼ buttons to select the rating you want.
4. Press the ◀ to exit and save your selection.

Restrict an entire channel

You may choose to block an entire channel using the Parental Controls feature. Restricted channels are indicated with a lock icon (🔒).

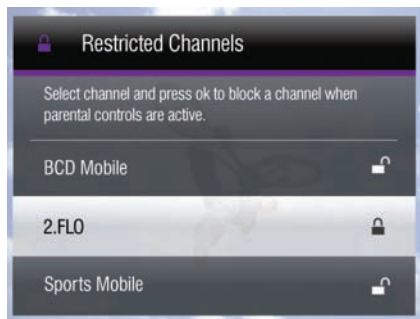

Check to confirm this is the right screen

To block channels

1. Select **Parental Controls** from the Settings menu. Confirm that Parental Controls is ON.
2. Select **Restricted Channels**.
3. Using the ▲ and ▼ buttons, select the channel you want to block.
4. Press the ⏸ button to block the channel.
5. Press the ◀ button to exit and save your selection.

Turn off Parental Controls

1. Select **Parental Controls** from the Settings menu.
2. Using the ▲ and ▼ buttons, enter the 4-digit PIN.
3. Press the ⏸ button to turn Parental Controls OFF. All programming is now allowed for viewing.

Reset your PIN

The following screen appears if you enter in an incorrect PIN.

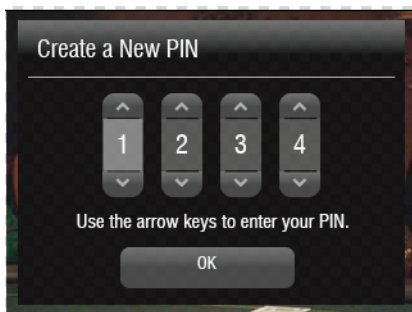

1. Select **Reset Pin** and press the ⏸ button.
2. You will be prompted to log on to www.flotv.com to reset your 4-digit PIN. Once your PIN has been reset, return to Parental Controls, enter a new PIN, and press the ⏸ button.

Managing Your Account Online

Access your **FLO TV** account to subscribe to additional **FLO TV** devices, change your subscription package, order special event programming, change your account information or view your order history.

EN

Log on to www.flotv.com and select **My Account**.

You can opt to:

Update your account profile	Change your login name, password, password challenge question and challenge answer, email address, phone number, or personal information.
Update your payment methods	Add a new method or delete or edit existing payment methods.
View your order history	See all of the orders you have placed. To view details of a particular order, click View Details .

DVD/CD playback

Starting playback of CD/DVD

- If watching FLO TV, press the MODE button to switch to DVD/CD mode.
- Press the DVD Cover Open Switch on the top of the device to open the cover.
- Insert a CD/DVD disc.
- Close the cover.
- The disc should start playback automatically.



Playing Audio CDs

- When playing an audio CD, press **DISPLAY** repeatedly (on remote control) to display the single elapsed time of the current track, single remain time of the current track, total elapsed time and total remain time. To turn the display off, select the Display Off option
- Use the Directional Keypad to navigate through the CD.
- Press **REP 1/ALL** repeatedly (on remote control) to repeat current track, repeat all or to turn off the repeat function.
- Press **REP A-B** (on remote control) to repeat a segment between two points (A and B), press **REP A-B** at the beginning of the segment you want to repeat. Allow the disc to play to the end of the segment to the end point (B). Press **REP A-B** again at the end of the segment. The segment plays repeatedly until you press **REP A-B** to resume normal playback.
- While playing from CDs, switch the audio format by pressing **AUDIO** repeatedly on remote control to select from stereo, mono left, mono right or mix-mono.

Play Kodak Picture CD

- The Kodak Picture CD will start playing automatically in slide show mode.

DVD Playback

- While playing from DVD, press  (on the unit)/ (on remote control) repeatedly to scan forward at 2x, 4x, 8x, 16x or 32x. The playback speed will return to normal when the DVD is playing back at 32x.



- While playing from DVD, press ◀ (on the unit)/⏮ (on remote control) repeatedly to scan backward at 2x, 4x, 8x, 16x or 32x. The playback speed will return to normal when the DVD is playing back at 32x.

DVD Menu

- When playing a DVD, the DVD disc's main menu will appear. The contents of the menu vary from disc to disc.
- Press **INFO** (on the unit) or **MENU** (on remote control) during playback to display the main menu. Some DVDs only allow you to select disc playback options using the DVD's main menu.
- To switch the audio format during playback of DVDs, press **AUDIO** repeatedly (on remote control) to select the audio language you desire. Some DVDs only allow access to this function through the DVD menu.



Playback operations

Playback Time and Remaining Time

- Press **DISPLAY** (on remote control) during playback to view the current title number, total number of titles, current chapter number, total number of chapters and elapsed playback time for the current title.
- Press **DISPLAY** (on remote control) repeatedly to view the remaining time of the current title, the elapsed playback time of the current chapter and the remaining time of the current chapter. To turn the display off, select the Display Off option.

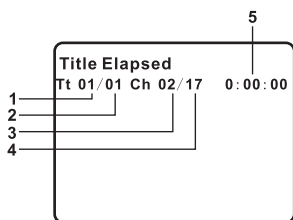

1. Current title number
2. Total number of titles
3. Current chapter number
4. Total number of chapters
5. Elapsed playback time for the current title

Note: Display function is only available on remote control.

Subtitle

- Press **SUB** (on remote control) repeatedly to select a desired language. To turn subtitles off, select the off option.
- This function may not be available on all discs.

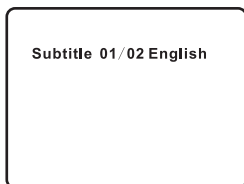

Note: Subtitle function can also be accessed through the Setting menu (refer to the Preference Page of DVD Settings section).

Audio

- Press **AUDIO** (on remote control) repeatedly to choose a desired language and audio formats during playback.
- This option is only available if the disc offers different languages or audio formats.
- Some DVDs only allow access to this function through the DVD menu.

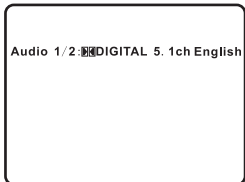

Note: Audio function can also be accessed through the Setting menu (refer to the Preference Page of DVD Settings section).

Zoom

- While a disc is playing, press **ZOOM** (on remote control) until you reach the zoom size you want. The **ZOOM** button cycles through 2x, 3x and 4x, then returns to normal playback.

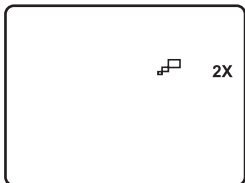

Note: Zoom function is only available on remote control

Repeat

- While the disc is playing, press **REP 1/ALL** (on remote control) repeatedly to select a repeat mode: repeat current chapter, repeat current title, repeat all chapters and titles and repeat off.

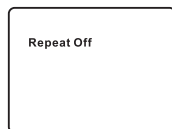
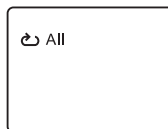
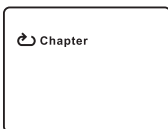

- To repeat a segment between two points (A and B), press **REP A-B** (on remote control) at the beginning of the segment you want to repeat. Allow the disc to play to the end of the segment to the end point (B). Press **REP A-B** (on remote control) again at the end of the segment. The segment plays repeatedly until you press **REP A-B** (on remote control) to resume normal playback.

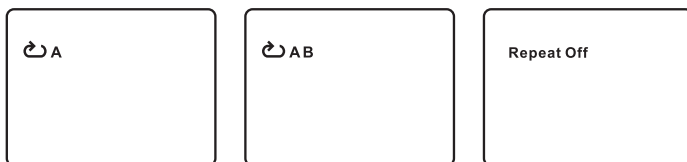

Note: Repeat function is only available on remote control.

Angle

Some discs offer different camera angles for specific scenes.

- To change the camera angle, press **ANGLE** (on remote control) repeatedly to select the camera angle.
- If the disc was recorded using a single camera angle, this function is not available.

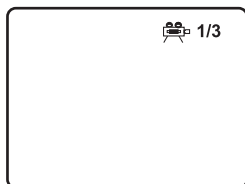

Note: If you want to access the angle function, adjust the setting through Setting menu before pressing **ANGLE** on remote control (refer to the General Setup Page section).

Playing JPEG files

After the disc is loaded,

EN

- Press ◀ or ▶ buttons to view the picture.
- Press ▼ button to rotate the picture clockwise.
- Press ▲ button to return to ROOT menu.
- Press **ZOOM** (on remote control) repeatedly to enlarge image by 125%, 150%, 200% or zoom out by 75%, 50% and return to the original size.
- You can also press **MENU** (on remote control) to enter thumbnail mode. Use the navigation buttons to select a photo, press  to start slideshow from the selected photo.

Connecting to headphones

- Simply plug the headphones into either Headphone jack 1 or Headphone jack 2 or both on the right side of the DVD Player.
- Plugging into Headphone jack 1 will disable the internal speakers.

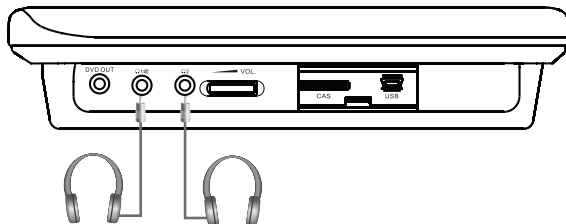

DVD settings

General setup page

Press SETTINGS button to enter the "General Setup Page".

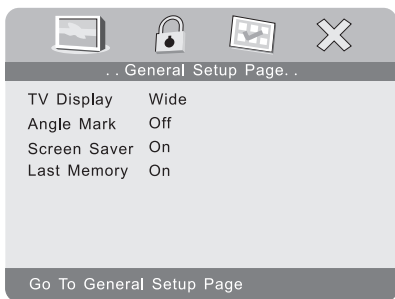

1. Select TV DISPLAY using the ▼ button, and then press ► to enter the submenu. Select the TV display mode on the screen using ▲ or ▼ buttons, and press ► to confirm the setting. Press the ◀ button to exit the TV DISPLAY menu.
- NORMAL/PS: The wide-screen image will be displayed on the normal TV (4:3) in its native aspect ratio, with some part on the left and right cut off.
 - NORMAL/LB: The wide-screen image will be displayed on the normal TV (4:3) in its native aspect ratio, with black bands on upper and lower sections of the screen.
 - WIDE: If the unit is connected to a wide-screen TV set, select this option. The widescreen image will be displayed in full screen in its native aspect ratio, while the 4:3 image will be stretched out vertically to fit in the screen.

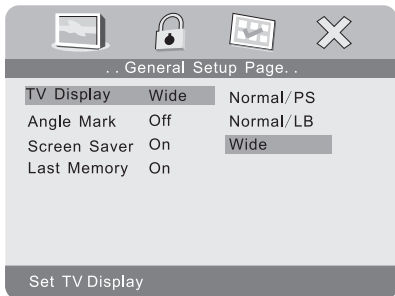



- **FLO TV** service is a 4:3 picture aspect ratio, and a normal picture will not fill the screen horizontally.
- **FLO TV** service does not play through a wide-screen or any TV set.



EN

2. Select **ANGLE MARK** using the ▼ button, and then press the ► button to enter the submenu. Choose Angle Mark on or off using the ▲ or ▼ buttons and then press ►|► button to confirm the setting. Press the ◀ button to return.

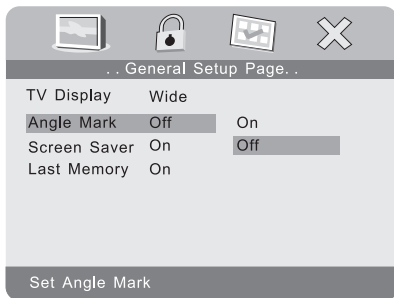

3. Select **SCREEN SAVER** using the ▼ button and then press the ► button to enter the submenu. Choose Screen saver on or off using the ▲ or ▼ buttons and then press ►|► button to confirm the setting. Press the ◀ button to return.

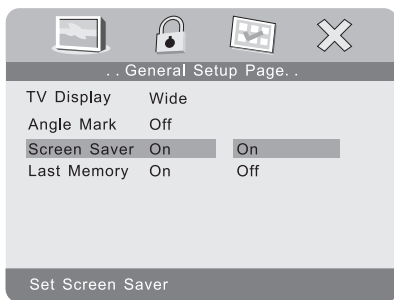

- On: Enables screen saver.
- Off: Disables screen saver.

The DVD player will enter the Screen Saver mode after approximately five minutes, if the same image remains on the screen.



4. Select LAST MEMORY by using the ▼ button, and then press the ► button to enter the submenu. Choose Last Memory on or off using the ▲ or ▼ buttons and then press the ►|| button to confirm the setting. Press the ◀ button to return.

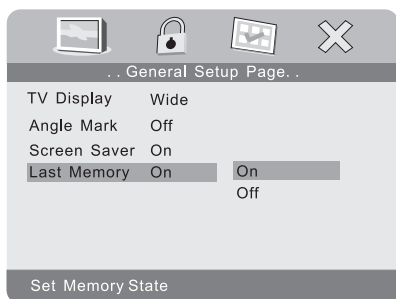

- On: During playback or in the pause mode, if you open the disc tray and then close without changing a disc, the unit will memorize the last playback status and resume playback from the memorized point.
- Power off or switch to **FLO TV** mode: The unit will not return to the last position on the disc.

Password setup page

Select PASSWORD using the ◀ or ► buttons, then press the ►|| button twice to enter the PASSWORD CHANGE PAGE. Use the ◀ or ► buttons to set the password. For example "◀,▶,◀,▶" "◀,◀,▶,▶".

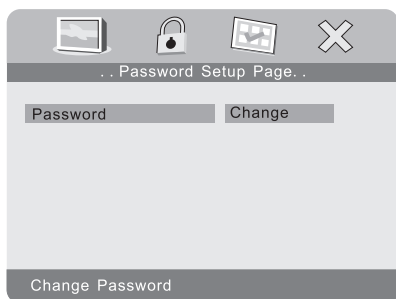



Use the ◀ or ▶ buttons to input the Old Password or the Default Password and then the New Password. Enter the new password again in the Confirmed PWD column. Press the ▶|| button to confirm the change.

EN

Please Enter Old Password

The default password is “◀, ◀, ▶, ▶”. This password is always effective even after you have selected your own password and changed it. To avoid the possibility of others using the default password to set the parental level and change the password, you can record this default password in another area and delete it from this manual. Some discs can be limited depending on the age of users while some discs cannot. Only the ◀ or ▶ buttons can be used to configure the password.

Preference page

With no disc inside the player select PREFERENCE PAGE using the ◀ or ▶ buttons, then press the ▶|| button to enter the PREFERENCE PAGE.

.. Preference Page ..	
Audio	ENG
Subtitle	off
Disc Menu	ENG
Parental	

Go To Preference Page



1. Select AUDIO using the ▼ button, then press the ►|| button to enter the submenu. Select the audio language you desire using the ▲ or ▼ buttons, then press the ►|| button to confirm the setting. Press the ◀ button to return.

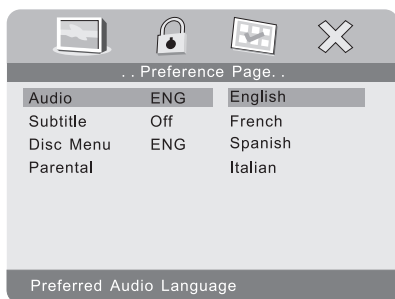

2. Select SUBTITLE using the ▼ button, then press the ►|| button to enter the submenu. Select the desired subtitle language or OFF using the ▲ or ▼ buttons, then press the ►|| to confirm the setting. Press the ◀ to return.

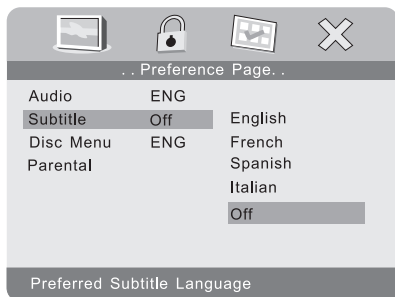

3. Select DISC MENU using the ▼ button, then press the ►|| button to enter the submenu. Select the Disc Menu Language you desire using the ▲ or ▼ buttons, then press the ►|| button to confirm the setting. Press the ◀ to return.

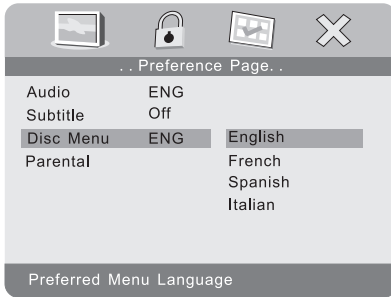

Language and subtitle selection is only available for discs that are recorded in the above listed languages. If the selected language is not available, the player will play and display on the screen the original recorded language contained in the disc.



- Select PARENTAL using the ▼ button, then press the ►|| button to enter the submenu.

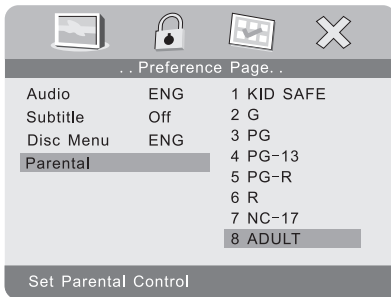

Select the parental level you desire using the ▲ or ▼ buttons for discs with lock-out function or multiple rating levels. These are listed from the lowest level (1 KID SAFE) to the highest level (8 ADULT). Enter a password using the ◀ or ▶ buttons, then press the ►|| button to confirm the parental level setting.



The level of 8 ADULT is the factory default. The parental setting is not affected by the default reset function.



System Setup Page

This menu is available from either FLO or DVD mode.

Press and hold **SETTINGS** button for about two seconds to enter the System Setup Page. Press **▲** or **▼** buttons to highlight the desired options and press **◀** or **▶** to adjust the values.

System Setup Page	
Osd Language	English
Airplane Mode	off
Wide	off
Brightness	0
Contrast	0
Saturation	0
Hue	0
Reset	
Quit	

1. OSD Language

Select among English, French and Spanish.

2. Airplane Mode (On/Off)

When the Airplane Mode is turned on, "Airplane Mode Enabled" will be displayed for about three seconds when you try to enter the **FLO TV** mode. This setting will be retained even after switched off the main power.

3. Wide (On/Off)

Switch between wide screen and 4:3 picture aspect ratio.

4. Brightness/Contrast/Saturation/Hue

Adjust from -20 to +20. Default value is 0.

5. Reset

Reset to factory default settings. This will reset all saved preferences in the settings options except the Parental Ratings and the default password.

6. Quit

Select this option to quit the System Setup Page. You can also press the **SETTINGS** button or wait for few seconds timeout to quite the System Setup Page.

Specifications

EN

Compatible DISC:	DVD, CD, CD-R, CD-RW, DVD+/-R, DVD+/-RW
Signal system:	NTSC
Panel size:	7 inch
Frequency response:	40 Hz to 20 kHz
Video output:	1 Vp-p/75 Ohm, unbalanced
Audio output:	1.4 Vrms/10K Ohm
Audio S/N:	Better than 60 dB
Dynamic range :	Better than 80 dB
Laser:	Semiconductor Laser, Wave Length: 650 nm/795 nm
Battery Specification:	Internal (non-user replaceable) Lithium polymer 2100 mAh, 7.4V
Power source:	DC 9-12 V
Power consumption:	13.5 W
Standby Power consumption:	< 1 mA @7.4 V
Operating temperature:	41~95°F (5~35°C)
Weight :	1.92 (lb)
Dimensions (W x D x H):	8.98 x 1.61 x 7.46 (inch)

Troubleshooting

FLO TV

FLO TV Screen/Problem	Explanation
 <p>2.FLO Currently out of coverage. Please try again later.</p>	<p>You may be out of a FLO TV coverage area; programming will resume when you are back in the coverage area.</p> <p>To check FLO TV coverage, visit www.flotv.com/maps.</p>
 <p>2.FLO To subscribe go to www.flotv.com</p> <p>If FLO TV has not been used for an extended period of time call 1-888-993-5688 to refresh your device.</p> <p>Device ID: 12345-67891-23456 Authorization Code: 1234-5678-9123</p>	<p>You will get this message for the following reasons:</p> <ol style="list-style-type: none"> 1. You are not subscribed to a FLO TV service plan which includes this channel. Go to flotv.com to subscribe 2. You are not subscribed to this time and/or event channel. Go to flotv.com to subscribe 3. Due to security reasons, if you have not viewed the FLO TV service for over 60 days your service will be placed on 'Hold'. In order to refresh your service, please call FLO TV Customer Care at 888-993-5688.
 <p>SPORTS</p> <p>Due to programming restrictions College Football Game ABC University vs. XYZ College has been blacked out</p>	<p>Sports programming is subject to blackout restrictions. Your program may be blacked out based on what area you live in due to programming restrictions.</p>
<p>The picture is not fitting-in the whole screen.</p>	<p>FLO TV service is a 4:3 picture aspect ratio, and a normal picture will not fill the screen horizontally.</p>

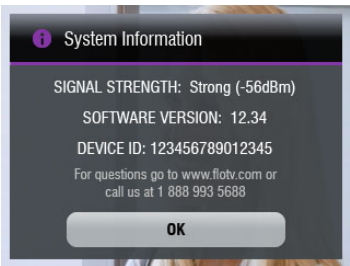
 <p>i System Information</p> <p>SIGNAL STRENGTH: Strong (-56dBm)</p> <p>SOFTWARE VERSION: 12.34</p> <p>DEVICE ID: 123456789012345</p> <p>For questions go to www.flotv.com or call us at 1 888 993 5688</p> <p>OK</p>	<p>Verify Signal Strength</p> <p>Select Settings and System Information to verify the signal strength.</p>
--	---

EN

DVD Playback

Problem	Solution
No sound or distorted sound	Make sure the DVD player is connected properly. Make sure all cables are securely inserted into the appropriate jacks.
Can't advance through a movie	You can't advance through the opening credits and warning information that appear at the beginning of movies because the disc is programmed to prohibit that action.
The icon (👉) appears on screen	<p>The feature or action cannot be completed at this time because:</p> <ol style="list-style-type: none"> 1. The disc's software restricts it. 2. The disc's software doesn't support the feature (e.g., angles) 3. The feature is not available at the moment. 4. You've requested a title or chapter number that is out of range.
Picture is distorted	<ul style="list-style-type: none"> • The disc might be damaged. Try another disc. • It is normal for some distortion to appear during forward or reverse scan.

No forward or reverse scan	<ul style="list-style-type: none"> • Some discs have sections that prohibit rapid scanning or title and chapter skip. • You will not be able to skip through the warning information and credits at the beginning of a movie. This part of the movie is often programmed to prohibit skipping through it.
IR sensor inoperative	<ul style="list-style-type: none"> • Verify that the batteries in the remote are fresh. • Verify that the remote sensor eye is not obstructed.
Disc won't play	Check the type of disc you put into disc tray. This DVD player only plays DVDs, audio CDs AND JPEG discs.
Play starts, but then stops immediately	<ul style="list-style-type: none"> • Your DVD player has been designed to process regional management information that is stored on DVD discs. The regional code for your player is 1 (The U.S., U.S. Territories and Canada). Only DVD discs that have regional codes of 1 or ALL (for all regions) can be played by your player. • The disc is dirty. Clean it. • Condensation has formed. Allow player to dry out.

Getting Help

Customer Support

EN

FLO TV Customer Care can answer questions about your account, coverage area, and specific features available on the **FLO TV** service.

Contact information:

Web: <http://www.flotv.com/help>

FAQ: <http://www.flotv.com/help/faq>

Email: <http://www.flotv.com/help/email-support>

Phone: 1-888-99-FLOTV (888-993-5688)

Audiovox Customer Care number: 1-800-645-4994

Before requesting support, try to reproduce and isolate the problem. When you contact the Customer Care Center, be ready to provide the following information:

- The actual error message or problem you are experiencing.
- The steps you took to reproduce the problem.
- The Device ID (may be found on back of the device)

For technical issues related to your device hardware, please contact Audiovox Customer Care

Index

Device

activation, 18

Help,

troubleshooting, 40-42

Ratings, 22-24

Warranty information

90 day Limited Warranty

Applies to Audiovox FLO TV Enabled Portable DVD Players

EN

AUDIOVOX ELECTRONICS CORP. (the Company) warrants to the original retail purchaser of this product that should this product or any part thereof, under normal use and conditions, be proven defective in material or workmanship within 90 days from the date of original purchase, such defect(s) will be repaired or replaced with reconditioned product (at the Company's option) without charge for parts and repair labor.

To obtain repair or replacement within the terms of this Warranty, the product is to be delivered with proof of warranty coverage (e.g. dated bill of sale), specification of defect(s), transportation prepaid, to the Company at the address shown below.

This Warranty does not extend to the loss/interruptions of the **FLO TV** service or internet service, the elimination of externally generated static or noise, to correction of antenna problems, to costs incurred for installation, removal or reinstallation of product, to corruptions caused by computer viruses, spyware or other malware, to loss of media, files, data or content, or to damage to tapes, discs, removable memory devices or cards, speakers, accessories, computers, computer peripherals, other media players, home networks or vehicle electrical systems.

This Warranty does not apply to any product or part thereof which, in the opinion of the Company, has suffered or been damaged through alteration, improper installation, mishandling, misuse, neglect, accident, or by removal or defacement of the factory serial number/bar code label(s). THE EXTENT OF THE COMPANY'S LIABILITY UNDER THIS WARRANTY IS LIMITED TO THE REPAIR OR REPLACEMENT PROVIDED ABOVE AND, IN NO EVENT, SHALL THE COMPANY'S LIABILITY EXCEED THE PURCHASE PRICE PAID BY PURCHASER FOR THE PRODUCT.

This Warranty is in lieu of all other express warranties or liabilities. ANY IMPLIED WARRANTIES, INCLUDING ANY IMPLIED WARRANTY OF MERCHANTABILITY, SHALL BE LIMITED TO THE DURATION OF THIS WRITTEN WARRANTY. ANY ACTION FOR BREACH OF ANY WARRANTY HEREUNDER INCLUDING ANY IMPLIED WARRANTY OF MERCHANTABILITY MUST BE BROUGHT WITHIN A PERIOD OF 12 MONTHS FROM DATE OF ORIGINAL PURCHASE. IN NO CASE SHALL THE COMPANY BE LIABLE FOR ANY CONSEQUENTIAL OR INCIDENTAL DAMAGES FOR BREACH OF THIS OR ANY OTHER WARRANTY. No person or representative is authorized to assume for the Company any liability other than expressed herein in connection with the sale of this product.

Some states do not allow limitations on how long an implied warranty lasts or the exclusion or limitation of incidental or consequential damage so the above limitations or exclusions may not apply to you. This Warranty gives you specific legal rights and you may also have other rights which vary from state to state.

Recommendations before returning your product for a warranty claim:

- If your product is capable of storing content (such as an mp3 player, digital voice recorder, etc), it is recommended to make periodic backup copies of content stored on the product. If applicable, before shipping a product, make a back up copy of content or data stored on the device. Also, it is advisable to remove any personal content which you would not want exposed to others. IT IS LIKELY THAT CONTENTS AND DATA ON THE DEVICE WILL BE LOST DURING SERVICE AND REFORMATTING. AUDIOVOX ACCEPTS NO LIABILITY FOR LOST CONTENT OR DATA, OR FOR THE SECURITY OF ANY PERSONAL CONTENT OR DATA ON THE RETURNED DEVICE. Product will be returned with factory default settings, and without any pre-loaded content which may have been installed in the originally purchased products. Consumer will be responsible for reloading data and content. Consumer will be responsible to restore any personal preference settings.
- Properly pack your unit. Include any additional items which were originally provided with the product. However DO NOT return any removable batteries, even if batteries were included with the original purchase. We recommend using the original carton and packing materials. Ship to:

Audiovox Electronics Corp.
Attn: Service Department.
150 Marcus Blvd.
Hauppauge N.Y. 11788

1-800-645-4994

Illustrations contained within this publication are for representation only and subject to change.

The descriptions and characteristics given in this document are given as a general indication and not as a guarantee. In order to provide the highest quality product possible, we reserve the right to make any improvement or modification without prior notice.

Las ilustraciones contenidas dentro de esta publicación son para propósitos de ilustración solamente y están sujetas a cambio.

Las descripciones y las características presentadas en este documento son dadas a modo de indicación general y no de garantía. Con el fin de proporcionarle la más alta calidad de producto posible, nos reservamos el derecho a hacer mejoras o modificaciones sin previo aviso.

FLO TV Incorporated f/k/a MediaFLO USA, Inc. and QUALCOMM Incorporated
5775 Morehouse Drive
San Diego, CA 92121-1714
U.S.A.

Copyright © 2010 **FLO TV** Incorporated, a Qualcomm company
All rights reserved

This technical data may be subject to U.S. and international export, re-export or transfer ("export") laws. Diversion contrary to U.S. and international law is strictly prohibited.

FLO and **FLO TV** are trademarks of QUALCOMM Incorporated.

QUALCOMM is a registered trademark of QUALCOMM Incorporated in the United States and may be registered in other countries.

All other trademarks and registered trademarks referenced herein are the property of their respective owners.

FLO TV Incorporated f/k/a MediaFLO USA, Inc. y QUALCOMM Incorporated
5775 Morehouse Drive
San Diego, CA 92121-1714
U.S.A.

Copyright © 2010 **FLO TV** Incorporated, una compañía Qualcomm
Todos los derechos reservados

Los datos técnicos pueden estar sujetos a leyes de los EE.UU. y exportación internacional, re-exportación o transferencia ("exportación"). La desviación en contra de la ley internacional y de los EE.UU. está estrictamente prohibida.

FLO y **FLO TV** son marcas registradas de QUALCOMM Incorporated.

QUALCOMM es una marca registrada de QUALCOMM Incorporated en los Estados Unidos y puede estar registrada en otros países.

Todas las otras marcas y marcas registradas aquí referidas son propiedad de sus respectivos propietarios.

Audiovox Electronics Corporation
150 Marcus Boulevard
Hauppauge, NY 11788
www.audiovox.com
© 2010 Audiovox Electronics Corp.

v3.0 (1.0.3.0) (EN/E)
128-8853

Trademark(s) ® Registered
Marca(s) ® Registrada(s)
Printed in China
Impreso en China