



ADVUNI400CP

6.2" Double DIN Multimedia Receiver

AM-FM / DVD / NAV / SiriusXM Ready™ / Pandora /
Bluetooth / iPhone® - iPod® / Screen Mirroring /
USB / AV In / Rear Camera In / CarPlay

Operation Manual

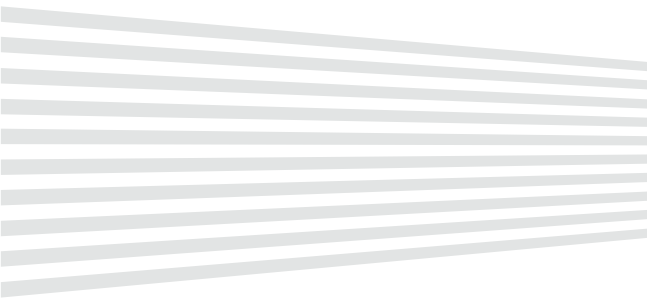

ADVUNI400CP

Android is a trademark of Google Inc.

Sirius, XM and all related marks and logos are registered trademarks of Sirius XM Radio Inc. All rights reserved.

microSD is a trademark or registered trademark of SD-3C, LLC in the United States, other countries or both.

Pandora® is a registered trademark of Pandora Media, Inc.

“Made for iPod,” and “Made for iPhone” mean that an electronic accessory (This head unit) has been designed to connect specifically to iPod®, or iPhone® , respectively, and has been certified by the developer to meet Apple performance standards.

Apple is not responsible for the operation of this device or its compliance with safety and regulatory standards. Please note that the use of this head unit with iPod® or iPhone® may affect mobile phone performance.

iPod®/ iPhone® are trademarks of Apple Inc., registered in the U.S. and other countries. Apple CarPlay is a trademark of Apple Inc.

ADVUNI400CP

CONTENTS

Features	5
Controls and Indicators	8
Remote Control	10
External Devices	13
Quick Start	14
Audio Equalizer	17
System Settings	19
Disc Operation	28
AM-FM Radio	40
USB / microSD card.....	45
iPod®/ iPhone® Connectivity.....	50
AV In1 / AV In2	54
HDMI / MHL Connectivity	55
Bluetooth / Hands Free Calling.....	58
Rear Camera	66
Steering Wheel Controls (SWC)	67
Pandora® Radio	68
SiriusXM® Radio	72
Apple CarPlay Operation.....	85
User Uploadable Wallpaper	87
Troubleshooting	88
Care and Maintenance	92
Specifications	93
Notes	95
Common Replacement Parts.....	Back Cover

ADVUNI400CP

FCC Statement

1. This device complies with Part 15 of the FCC Rules.

Operation is subject to the following two conditions:

(1) This device may not cause harmful interference, and

(2) This device must accept any interference received, including interference that may cause undesired operation.

2. Changes or modifications not expressly approved by the party responsible for compliance could void the user's authority to operate the equipment.

NOTE: This equipment has been tested and found to comply with the limits for a Class B digital device, pursuant to Part 15 of the FCC Rules. These limits are designed to provide reasonable protection against harmful interference in a residential installation.

This equipment generates, uses and can radiate radio frequency energy and, if not installed and used in accordance with the instructions, may cause harmful interference to radio communications. However, there is no guarantee that interference will not occur in a particular installation. If this equipment does cause harmful interference to radio or television reception, which can be determined by turning the equipment off and on, the user is encouraged to try to correct the interference by one or more of the following measures:

- Reorient or relocate the receiving antenna.
- Increase the separation between the equipment and receiver.
- Connect the equipment into an outlet on a different from that to which the receiver is connected.
- Consult the dealer or an experienced radio/TV technician for help.

FCC Radiation Exposure Statement

This equipment complies with FCC radiation exposure limits set forth for an uncontrolled environment. This equipment should be installed and operated with minimum distance of 20 centimeters between the radiator and your body.

ADVUNI400CP

Thank you for choosing a Advent product. We hope you will find the instructions in this owner's manual clear and easy to follow. If you take a few minutes to look through it, you'll learn how to use all the features of your new Advent ADVUNI400CP Multimedia Receiver for maximum enjoyment. Please save this manual for future reference.

We recommend having your Advent ADVUNI400CP Multimedia Receiver installed by a reputable installation shop.

FEATURES

DVD

- Audio Equalizer
- Next Chapter and Previous Chapter
- Play/Pause
- Track Direct Entry
- Disc Menu
- Selection Repeat / Track Repeat
- Disc Audio
- Disc Language
- Picture Adjustment

CD / MP3 / WMA

- CD-Text Compatible
- ID3 Tag Compatible
- MP3 and WMA Files on a DVD+R / RW
- Random, Repeat and Intro
- Play, Pause, Stop, Next Track and Previous Track

AM-FM Tuner

- Region Support: USA, Asia, Japan, Europe, Europe LW (Long Wave), Oirt and Brazil
- RBDS w/ Clock Time, Radio Text (RT), Program Service (PS) and Program Type (PTY)
- 30 Station Presets (18 FM / 12 AM)
- Auto Stereo / Mono
- Local / Distance
- Autostore

iPod®/iPhone®

- iPod®/ iPhone® via USB
- High Speed Direct Connect Interface to Access iPhone® and iPod® Playlists, Artists, Albums
- Power Management Charges iPhone® / iPod® while Connected

ADVUNI400CP

SiriusXM Ready®

- Satellite Channel Name, Artist, Song, and Categories Displayed on Monitor (Vehicle Tuner and Subscription required and sold separately)

Chassis

- 2.0 DIN (Import / ISO-DIN Mountable)
- Fixed Front Panel
- 6.2" High Definition TFT LCD
- 800h x 480w x RGB WVGA

General

- Beep Tone Confirmation (ON-OFF Option)
- Bluetooth Hands-Free operation for safety and convenience and A2DP for streaming music from your smartphone.
- One Composite Video Output for Additional Screens
- Front Panel Audio/Video Input
- Front Panel USB - Playback Music / Video Files via Portable Hard Drives / USB flash drives; Rear USB (for charging only)
- 10 Band Graphic Equalizer
- 6VRMS Front / Rear / Subwoofer RCA Line Output
- Rear Camera Input
- Touch Screen Calibration Mode
- Rotary Encoder Audio Control
- Screen Mirroring - See and control smartphone apps on the larger TFT screen.
*Some apps may not be supported.
- USB Charging Current - 2.1 Amp Support

Rear Camera

- The ADVUNI400CP is "camera ready." Before accessing any camera features, you must purchase and install a rear video camera.

Built-In Navigation

- iGo Primo Next Gen Navigation Engine
- USA Map Data (Tele Atlas)
- >10 Million Points of Interest
- 4GB SD Card w/ Navigation Software
- Latest Map Guarantee (Must be redeemed within 30 days of initial activation)
- 13 Natural Voice Languages for Navigation Guidance
- TTS (Text to Speech) Voice Guidance - Street Names Pronounced

ADVUNI400CP

CarPlay

Smart interface that uses Siri to enable hands-free control of music, navigation, phone and messaging apps.

- Make phone calls and check voicemail
- Send, read and reply to text messages
- Access music by artist, song, playlist and more
- Search by address or point of interest, or request turn-by-turn directions

WARNING! To reduce the risk of a traffic accident (except when using for rear view video camera) never use the video display function while driving the vehicle. This is a violation of federal law.

WARNING! Never disassemble or adjust the unit.

WARNING! To prevent injury from shock or fire, never expose this unit to moisture or water.

WARNING! Never use irregular discs.

WARNING! Using an improper fuse may cause damage to the unit and result in fire.

ADVUNI400CP

CONTROLS AND INDICATORS



ADVUNI400CP Controls and Indicators

- 1. Disc Slot:**
Accepts DVD/CD/MP3 discs. If the unit is turned on, playback begins when a disc is inserted.
- 2. LCD Screen and Touch Screen:**
Touch icons on this screen to access menus or control functions.
- 3. Remote Sensor:**
Used to receive command signals from the remote control.
- 4. 3.5mm AV IN Jack:**
This connector accepts a 3.5 mm jack through which signals from various audio/video devices can be applied to the unit.
- 5. microSD Card Slot:**
Used to insert microSD cards containing navigation software. Do not delete or modify SD card contents.

ADVUNI400CP

6. **USB Slot:**
Used to connect an iPhone/iPod®, MP3 player or USB flash drive for playback of music/video files.
7. **Interface Cover:**
Covers the 3.5mm AV In, microSD card and USB slot.
8. **Reset Button:**
Press this button to reset the system settings (except password and parental lock settings) and to correct a system halt or other illegal operation. Use the tip of a pen to press the Reset button.
9. **Power On/Off (⏻) Button / Rotary Volume (⏵) Knob / Mute Button**
Press to turn the unit ON. Press and hold to turn the unit OFF.
Rotate the knob to adjust the volume.
Press the knob momentarily to mute the audio. Press the knob again to restore the audio.
10. **Push to Talk:**
Press this button to access Siri or Google Voice through the head unit when connected via BT. Your mobile phone must support Siri or Google Voice in order for this feature to be supported on the head unit.

NOTE:
Samsung "S" Voice and other third-party apps may not be supported.
11. **Eject (▲) Button:**
Press this button to eject a DVD/CD/MP3 disc. Disc play is stopped, the disc is ejected and the unit will change to radio operation. If the disc is not removed from the unit and the button is pressed again, the disc will be re-loaded. If the disc is not removed from the disc slot within 10 seconds of being ejected, it will be automatically reloaded to prevent it from being accidentally damaged.

ADVUNI400CP

NOTES ON REMOTE CONTROL USAGE

- Aim the remote control at the TFT/screen.
- Remove the battery from the remote control or insert a battery insulator if the remote control will not be used for a month or longer.
- DO NOT store the remote control in direct sunlight or in a high temperature environment, or it may not function properly.
- The battery will last for 6 months under normal conditions. If the remote control does not work, please change the battery.
- Use lithium battery type CR2025 (3V) only.
- DO NOT recharge, disassemble, heat or expose the battery to fire.
- Insert the battery in the proper direction according to the (+) and (-) polarity marks.
- Store the battery in a place where children cannot reach it to avoid the risk of an accident.

ADVUNI400CP

Remote Control Function Description

- 1. SOURCE (SRC) Button:** Press this button to switch between and select available sources.
- 2. EJECT Button (▲):** Press this button to eject a DVD/CD/MP3 disc. Disc play is stopped, the disc is ejected and the unit will change to radio operation. If the disc is not removed from the unit and the button is pressed again, the disc will be re-loaded. If the disc is not removed from the disc slot within 10 seconds of being ejected, it will be automatically reloaded to prevent it from being accidentally damaged.
- 3. AUDIO Button:** Press to display and select the audio language in DVD mode. Each time the button is pressed, the language changes.
NOTE: The languages for audio vary from disc to disc.
- 4. VOLUME Button (VOL + and -):** Press these buttons to increase or decrease the playback volume.
- 5. BAND Button:** Press this button to select FM1, FM2, FM3, AM1 or AM2.
- 6. REPEAT (RPT) Button:** Repeat playback.
- 7. MUTE Button:** Press this button to turn the audio output ON and OFF.
- 8. POWER Button (⏻):** Press this button to turn the unit ON and OFF.
- 9. SUBTITLE Button:** Press to display and select the subtitle language in DVD mode. Each time the button is pressed, the subtitle language changes. **NOTE: The type and number of languages for subtitles vary from disc to disc.**
- 10. MENU Button:** Press this button to access the root menu of a DVD or CD during playback. The disc will return to normal playback and the root menu will disappear if no selection is made within 10 seconds.
- 11. FAST FORWARD [▶▶] Button:** Press this button to forward Disc play 2x, 4x, 8x or 20x normal speed. Press this button while in Radio mode to search available radio station by increasing tuning frequency.

ADVUNI400CP

12. **NEXT (▶▶) Button:** Press this button to skip to the next chapter, track or song during playback of a disc. Press this button while in Radio mode to search available radio station by increasing tuning frequency.
13. **PLAY / PAUSE (▶/||) Button:** Press this button to pause the playback of a disc. Press this button again to resume normal playback.
14. **PREVIOUS (◀◀) Button:** Press this button to go back to the previous chapter, track or song during playback of a disc. Press this button while in Radio mode to search available radio station by decreasing tuning frequency.
15. **FAST REVERSE [◀◀] Button:** Press this button to reverse Disc play 2x, 4x, 8x or 20x normal speed. Press this button while in Radio mode to search available radio station by decreasing tuning frequency.
16. **NUMBER Buttons (1-6):** Press these buttons to directly access chapters and tracks, dialing phone numbers, or entering passwords.
17. **RANDOM (RDM) Button:** Press this button to play tracks or chapters in random order while playing a disc.



ADVUNI400CP

EXTERNAL DEVICES

Connecting External Devices

External devices, including a game console, video camera, etc. can be connected to this unit using its front A/V In 3.5mm connector (AV In1), the rear RCA inputs (AV In 2) or the front or rear USB ports.

NOTE:

The rear USB is for charging only (not playback).

You cannot directly control external devices connected to the A/V inputs using the front panel controls or this unit's remote control.

AV In 1

AV In1 is used for playback of audio/video from an external device connected to the unit through a 3.5mm connector. The unit can increase or decrease the volume of the connected device. All other controls are done on the connected device. Select AV In1 to playback audio/video from the front panel 3.5mm AV In.

AV In 2

AV In2 is used for playback of audio/video from an external device connected to the RCA connectors located on the back of the unit (see the ADVUNI400CP Installation Guide). The unit can increase or decrease the volume of the connected device. All other controls are done on the connected device. Select AV In2 to playback audio/video from the rear RCA AV In

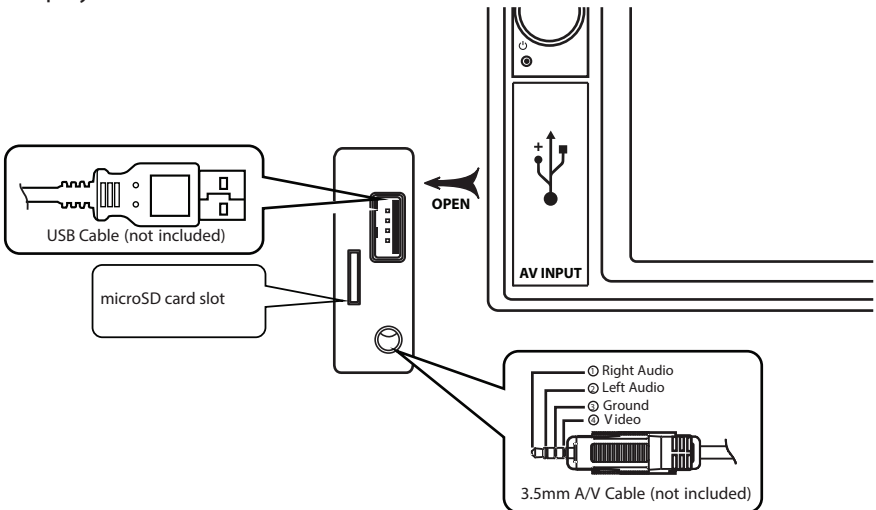

Connecting External Devices

ADVUNI400CP

QUICK START GUIDE

Turning the Unit ON or OFF

Press the front panel volume knob to turn the unit ON. Press and hold the volume knob > 1 second to turn the unit OFF.

Selecting AM-FM Tuner, Disc, USB, Pandora, SXM, etc

To select a source:

1. Press the the front panel volume knob momentarily or touch the SRC icon to view the Main Source Menu.



ADVUNI400CP Front Panel

2. Touch the desired source icon on one of the two main menu screens.

Screen 1 of 2: Radio, CarPlay, USB, Navigation, Bluetooth, Screen Mirroring or SXM.

Screen 2 of 2: Disc, AV In 1, AV In 2, Camera, Pandora, iPod or Settings.

Touch Next or Previous at the bottom of the screen to move from one screen to another.

ADVUNI400CP

System Settings Adjustment

To access and adjust system settings:

1. Touch the Settings (⚙️) icon on the Main Menu screen to enter the SETTINGS MENU. Sub-menus where adjustments can be made will be highlighted.

Volume Adjustment / Turn On Volume

To increase or decrease the volume level, rotate the rotary encoder knob. The unit's front panel screen will display the volume level for 2 seconds. The volume level ranges from 0 to 50. To set the Turn-On volume, press and hold the rotary encoder knob 1 second while the green volume bar is displayed after setting the desired volume level. You will hear 2 beeps to confirm the new Turn-On volume level.

Audible Beep Confirmation

An audible beep tone confirms each function selection. The beep tone can be disabled through the Setup menu.

Selecting the Source

If you are in navigation mode, and short press the rotary encoder, the unit will go to the Main Source Menu. If you press the RE again, you will be taken to the currently selected audio source.

Equalizer Controls

Equalizer (**EQ**): Adjustment can be made after entering one of the audio/video sources (Disc, Radio, USB, AV-IN or SXM).

Touch the equalizer (**EQ**) icon to view the equalizer control screen to select flat setting, custom user setting, make adjustments to the audio balance and fader levels or to turn the loudness option ON or OFF. Touch **SRC** to return to the current source.

ADVUNI400CP

Playing a Disc

To begin playback of an Audio/Video Disc:

1. Press the front panel Power On/Off ($\text{\textcircled{P}}$) button / Rotary Volume ($\text{\textcircled{R}}$) knob to turn the unit ON.
2. Insert a disc with the label side facing up. Playback will begin automatically.

To eject a disc:

1. Press the front panel Eject ($\text{\textcircled{E}}$) button.

Resetting the System

Soft Reset - To correct a system halt or other illegal operation, use the tip of a pen to press and release the reset button located just below the front panel interface cover.

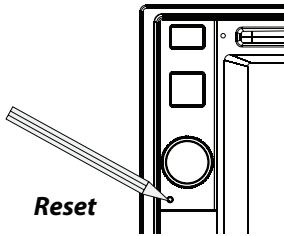

System Reset Button

After a system reset, the unit restores all factory default settings.

Note: If the unit is reset while a DVD is playing, the unit will return to Main Menu once the reset is complete.

Parking Brake Inhibit

When the pink "Parking" wire is connected to the vehicle parking brake circuit, the front TFT monitor will display video when the parking brake is engaged.

ADVUNI400CP

EQUALIZER CONTROL MENU

Adjusting Equalizer Controls

The equalizer adjustment screen allows the user to easily adjust the audio system to meet the acoustical characteristics of the vehicle. The acoustical characteristics vary depending on the type of vehicle and measurements.

The balance/fader levels and loudness ON/OFF option of a selected audio/video source (Disc, Radio, USB/iPod®, AV-IN1, AV-IN2 or SXM) is also adjusted through the equalizer adjustment screen.

10 Band Equalizer (EQ)

1. Touch the equalizer (EQ) icon to view and adjust the eq / balance / fader.

Note: The equalizer will automatically change to “USER” when individual audio functions are adjusted.



Equalizer Adjustment Screen

2. Select a desired frequency range to be adjusted (31.5, 62.5, 125, 250, 500, 1K, 2K, 4K, 8K or 16K).
3. Touch and move the slide bar Up / Down to adjust the amount of boost/cut from +10/-10dB.

ADVUNI400CP

Reset

Touch the Reset icon to reset the 10 equalizer band frequencies to the mid point.

Loudness

Touch the Loud icon to turn the loud option ON or OFF. The loud option automatically alters the frequency response curve of audio to make it sound more natural when played at a lower volume level.

Exiting the Equalizer

To exit the Equalizer menu touch the **SRC** icon to return to the current source.

Fader-Balance

Balance - Touch the **FAD-BAL** icon on the left side of the equalizer screen to display the balance/fader screen.



Fade-Balance Adjustment Screen

Balance - This feature is used to balance the audio output levels between the left and right side of the vehicle. Touch the ◀ or ▶ icons to change the balance control settings -20 (Left) to +20 (Right). The setting can also be changed by touching screen within the grid to move the sphere.

Fader - This feature is used to fade the audio output levels between the front and rear of the vehicle. Touch the ▲ or ▼ icons to change the fade control settings -20 (Rear) to +20 (Front). The setting can also be changed by touching screen within the grid to move the sphere.

Sub (Subwoofer) - This feature is used to reduce or increase the subwoofer sound level. Touch the slide bar ▲ or ▼ icons to adjust the settings.

Exiting the Balance-Fader

To exit the balance-fader touch the **SRC** icon on the top left corner of the screen.

ADVUNI400CP

SYSTEM SETTINGS

To access System Settings, touch the  icon on the Main Menu screen. There are seven System Settings Sub-Menus (General, Audio, Time, Language, Bluetooth, DVD or Volume) that are used to adjust the performance of each option of the ADVUNI400CP. The Version Sub-Menu is for information only. Touch a desired Sub-Menu and the Sub-Menu will appear highlighted. The features available for adjustment will appear on the screen.

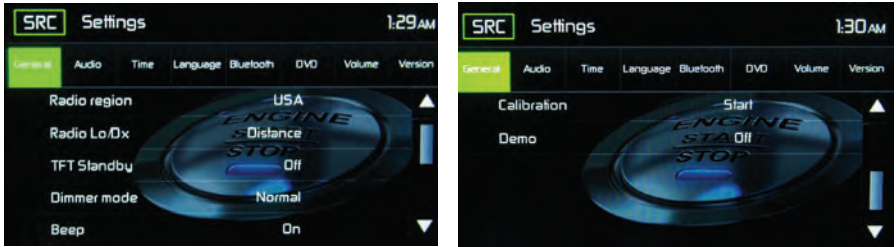

System Settings Screens

Adjusting a Sub-Menu Feature

1. Touch the Sub-Menu feature to be adjusted.
2. Touch the ▲ or ▼ icon to view the previous or next feature page, if applicable. An options list appears on the right.
3. Touch the desired feature option once to make selection then touch again to confirm the selection.

General Sub-Menu Features - Radio Region/Frequency Spacing

USA - FM - 200kHz / AM - 10kHz

China - FM - 50kHz / AM - 9kHz

Japan - FM - 100kHz / AM - 9kHz

Europe - FM - 50kHz / AM - 9kHz

Europe (LW) - FM - 50kHz / AM - 9kHz / LW - 30kHz

OIRT - FM - 50kHz / AM - 9kHz / OIRT - 30kHz

Radio Lo/Dx - Touch the Distance or Local to increase or decrease radio tuning sensitivity to receive local or distant stations.

TFT Standby - Touch OFF, 10s or 20s to set the unit's front panel TFT LCD screen to stay ON continuously or to turn off the screen after 10 or 20 seconds.

Display Adjust - Touch Night, Dark, Normal or Bright to set the unit's front panel TFT LCD screen to be adjusted for day and night conditions.

ADVUNI400CP

Beep - Touch ON or OFF to turn the selection confirmation beep ON or OFF.

Wallpaper - Touch wallpaper selection to select wallpaper. Touch again to confirm and set the wallpaper.

Calibration- The Touch Screen Calibration adjustment is used to set the parameters of the touch screen to ensure that when the screen is touched, it corresponds to the feature desired.

Note: Never use a pen or sharp object to calibrate the touch screen as this will damage the panel. Use your index finger to calibrate the screen.

1. Touch the Calibrate icon and the first screen will appear with instructions.
2. Follow the instructions on the screen touching and momentarily holding finger or a stylus to the center of the target for 2 seconds. Repeat as the target moves to each corner of the screen and finally to the center.

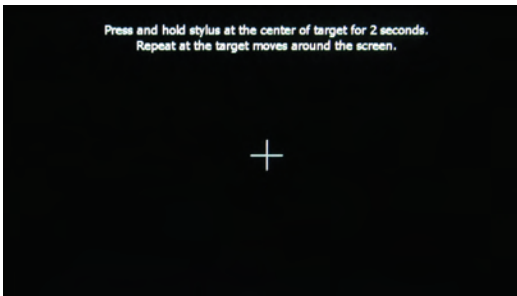

Calibration Screen

3. The second screen will appear:

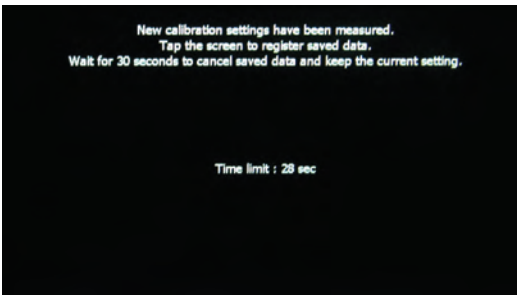

Calibration Screen Confirmation

4. If the screen is touched, the new calibration parameters will be accepted. If the screen is not touched within thirty seconds, the new parameters will be disregarded.

ADVUNI400CP

Illumination - Customize the front panel illumination. Touch to change the illumination color. Select a color or touch Custom > Adjust to select the color palette.



Front Panel Illumination Adjustment User Interface

UI Color - Touch green, red, amber, blue or purple to select the user interface color. Touch again to confirm and set the color.

Demo - Touch ON or OFF to turn the demonstration mode ON or OFF. The factory default setting is ON.

Rear View Camera - Select between MIRROR or NORMAL view.

ADVUNI400CP

Audio Sub-Menu Features

The Audio Sub-Menu is used to turn the Subwoofer output ON or OFF and to select a Subwoofer crossover frequency.



Audio Sub-Menu Screen

Subwoofer - Touch ON or OFF to turn the subwoofer output ON or OFF.

Subwoofer Crossover - Touch a crossover frequency (80Hz, 120Hz or 160Hz) to set a cut-off frequency for the subwoofer's low-pass filter (LPF).

Reverse Camera Audio - Select between ON or OFF.

Time Sub-Menu Features

The clock appears in the top right corner of the screen during certain operations.

Note: The AM/PM indication will change as you continue to adjust the hour past 12.

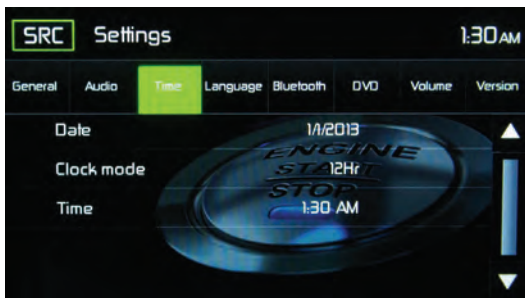

Time Sub-Menu Screen

Date - Touch the Date icon and use the ▲ or ▼ icons to set the day, month, and year. After setting the date, touch Save. The date will appear to the right of the Date option.

Clock Mode - Touch 12Hr to set the clock display to 12 hour time intervals using AM and PM. Touch 24Hr to set the clock display to a 24 hour time interval (or military time).

ADVUNI400CP

Time - Touch the Time icon and use the ▲ or ▼ icons to set the hour, minute, and either AM or PM. After setting the time, touch Save. The time will appear to the right of the Date option.



Date Settings



Time Settings

Date and Time Setting Screens

Language Sub-Menu Features

If a DVD supports more than one Subtitle or Audio language, all the languages are available for selection during playback. If the selected language is not supported by the DVD, then the default language is used.



Language Sub-Menu Screen

On Screen Display (OSD) - Touch English, Spanish or French to select the language for the OSD Display.

DVD Audio - If available, this feature allows the user to select one of the languages contained on the disc for the DVD audio.

DVD Subtitle - If available, this feature allows the user to select one of the languages contained on the disc for the DVD subtitles.

DVD Menu - Allows the user to select one of the languages contained on the disc menu.

ADVUNI400CP

Bluetooth Sub-Menu Features

The Bluetooth audio capabilities can be used for hands free applications. Before attempting to use the Bluetooth functions on this unit, please make sure the mobile phone to be connected supports Bluetooth functions.



Bluetooth Pairing Code Screen 2

Bluetooth - Touch ON or OFF to turn the Bluetooth function ON or OFF.

Auto-Connect - Touch ON or OFF to turn the Bluetooth Auto-Connect function ON or OFF.

Auto-Answer - Touch ON or OFF to turn the Bluetooth Auto-Answer function ON or OFF.

Pairing - This feature allows the user to create a unique 4 digit code for pairing Bluetooth devices to the unit. The factory default pairing code is "5309".

1. Touch the Paring Code icon and the Pairing Code entry screen will appear.
2. Use the keyboard to enter a unique 4-digit Pairing Code.
3. Touch OK to confirm 4 digit pairing code.

Note: If a wrong digit is entered touching the arrow will remove the number.

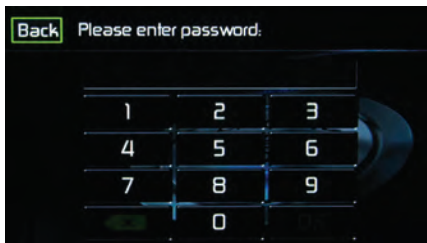

Pairing Code Entry Screen

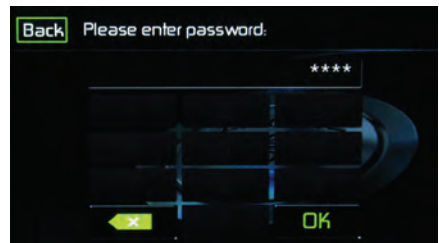

Pairing Code Confirmation Screen

Pairing Code Screens

ADVUNI400CP

DVD Sub-Menu Features

The DVD system has a built-in parental lock feature to prevent unauthorized persons from viewing restricted disc content. By default, the rating system is unlocked. Once set up, the parental lock is released only by entering the correct password. Once the password is entered, rating is available for setup.

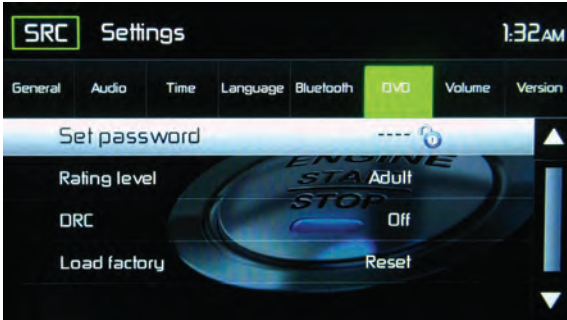

DVD Sub-Menu Screen

Set Password - This feature allows the user to create a unique 4-digit password to activate or deactivate the “Rating” option.

1. Touch the Set Password Code icon and the password entry screen will appear.
2. Use the keyboard enter a unique 4 digit Password.
NOTE: If a wrong digit is entered touching the green arrow will remove the number.
3. Touch OK to confirm 4 digit Password.

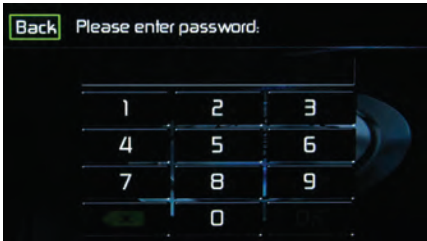

Password Entry Screen

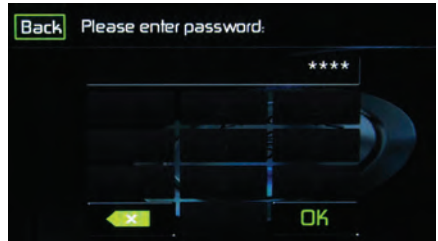

Password Confirmation Screen

DVD Password Screens

Rating Level - Select the appropriate rating level for the intended viewing audience (Kid Safe, G, PG, PG-13, PG-R, R, NC-17, and Adult). The user may override higher ratings by using the password.

DRC - This feature allows the user to turn the Dynamic Range Control ON for better playback for low volumes or OFF.

ADVUNI400CP

Load Factory - This feature allows the user to “Reset” the factory default settings. To reset the password, access the “RATING” menu and enter the current password. Once the correct password is entered, you can access the “Password” field and enter a new one.

Note: Record the password and keep it in a safe place for future reference. The rating for each disc is marked on the disc, disc package, or documentation. If the rating is not available on the disc, the parental lock feature is unavailable. Some discs restrict only portions of the disc, allowing the appropriate content will play. For details, please refer to the disc description.

Volume Sub-Menu Features

The Volume Sub-Menu allows the user to increase or decrease the relative volume (+/- 6dB) of the audio output of each source individually.

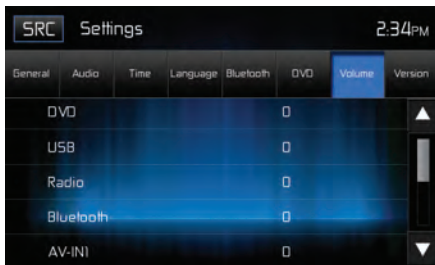

Volume Sub-Menu Screen 1

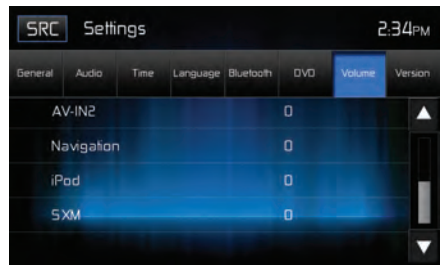

Volume Sub-Menu Screen 2

Volume Sub-Menu Screens

DVD - Touch the DVD icon to enter the setting, then use the ▲ or ▼ icons increase or decrease the relative volume level between -6 to +6.

USB - Touch the USB icon to enter the setting of the connected device, then use the ▲ or ▼ icons to increase or decrease the relative volume level between -6 to +6.

Radio - Touch the Radio icon to enter the setting, then use the ▲ or ▼ icons increase or decrease the relative volume level between -6 to +6.

Bluetooth - Touch the Bluetooth icon to enter the setting of the connected device, then use the ▲ or ▼ icons to increase or decrease the relative volume level between -6 to +6.

ADVUNI400CP

AV In 1 - Touch the AV In 1 icon to enter the setting of the connected device then use the ▲ or ▼ icons to increase or decrease the relative volume level between -6 to +6.

AV In 2 - Touch the AV In 2 icon to enter the setting of the connected device then use the ▲ or ▼ icons to increase or decrease the relative volume level between -6 to +6.

Navigation - Touch the Navigation icon to enter the setting of the connected device then use the ▲ or ▼ icons to increase or decrease the relative volume level between -6 to +6.

iPod - Touch the iPod icon to enter the setting then use the ▲ or ▼ icons to increase or decrease the relative volume level between -6 to +6.

SXM - Touch the SXM icon to enter the setting then use the ▲ or ▼ icons to increase or decrease the relative volume level between -6 to +6.

Screen Mirroring - Touch the iPod icon to enter the setting then use the ▲ or ▼ icons to increase or decrease the relative volume level between -6 to +6.

The default relative volume level setting for all available sources is "0".

Version Sub-Menu Features

The Version Sub-Menu is used to identify the model and resident operating system as well as the hardware and software versions.



Version Sub-Menu Screen 1



Version Sub-Menu Screen 2
(sample includes Firmware after OS Version)

Exiting the System Setup Menu

To exit setup mode and resume normal playback, touch the SRC icon on the screen.

ADVUNI400CP

DISC OPERATION

Compatible Audio Discs Types

This system will play the following types of discs:

- DVD - DVDs that contain audio and/or video.
- Audio discs - Audio CDs that contain audio files.
- MP3 discs - A disc that contains audio, video and image files (for example, a CD-R with downloaded MP3 files).

Note: This unit is designed to play pre-recorded (original) CD/DVDs. Some burned CD/DVD's may not play due to different recording formats/speeds.

DVD Operation

Note: When properly installed, DVD video cannot be displayed on the main TFT screen unless the parking brake is applied. If you attempt to play a DVD while the vehicle is moving, the TFT screen displays:

Warning: It is illegal to view video while driving or operating a motor vehicle. Set parking brake to view video.

From the Main Menu Screen touch the DISC Icon or insert a disc into the disc slot, label side up. Playback begins when a disc is inserted correctly.

DVD Main Menu

When a DVD is playing, touch the TFT LCD screen to view the DVD main menu. The on-screen icons and touch key areas are outlined below.

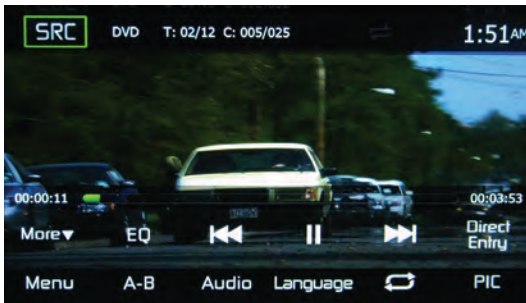

DVD Main Menu

SRC Icon - Touch this icon to return to the Main Menu Screen.

DVD - Displays the current source.

ADVUNI400CP

Title/Chapter Information - The title/chapter information displayed is the current number of the track playing, the total number of tracks on the disc, the current chapter playing and the total number of chapters on the disc.

Time Display - This indicator displays the time as entered by the user in the Settings Menu.

Chapter Elapsed Playback Time - The elapsed playback time of chapter is displayed on the screen.

Total Playback Time - The total playback time of disc is displayed on the screen.

More (▲/▼) - Touch the ▲/▼ icons to display the next or previous page of the Disc menu.

(EQ) Equalizer - Touch this icon to access the Equalizer Control Menu. (See "Adjusting Equalizer Controls")

(◀◀) Previous - Touch this icon to play the previous track.

(▶/||) Play/Pause - Touch this icon to begin disc playback. Touch this icon again to pause disc playback.

(▶▶) Next - Touch this icon to play the next track.

Direct Entry - Touch this icon to the display the Direct Entry Screen.

Menu - Touch this icon to view the DVD root menu.

A-B - Touch to repeat a specific portion from point A to point B of the disc. During playback touch A-B to set the starting point A. Touch A-B a second time to set the ending point B. The player will repeatedly play the part between Point A and Point B. Touch A-B a third time to cancel A-B repeat and resume playback.

Audio - Touch this icon to select an audio language for DVD playback. The audio language selection depends on the languages contained on the disc.

Language - Touch this icon to select a subtitle language for DVD playback. The subtitle language selection depends on the languages contained on the disc.

ADVUNI400CP

(↺) Repeat - Touch this icon during playback to repeat the current chapter. The icon on the screen will light and small letter C will appear below the icon and the chapter will repeat. Touch this icon a second time to repeat the current title. The icon on the TFT LCD screen will light and small letter T will appear below the icon and the title track will repeat. Touch the icon a third time to repeat the title and chapter. The icon on the main TFT LCD screen will light and small letter A will appear below the icon and the title and chapter will repeat. Touch the icon again the repeat function will be cancelled. The icon on the main TFT LCD screen will dim and playback of the remainder of the disc will resume.

PIC - When the PIC icon is touched the picture adjust screen appears. Touch this icon during playback to adjust the color brightness, contrast, saturation and hue. The levels can be adjusted to suit the users preferences. The adjustments are accomplished by touching the + or - icons to decrease or increase the desired setting. The settings have range of 1 to 20.

Note: The Picture Adjustment Screen will turn OFF automatically if no adjustment is made within five seconds or any other part of the screen is touched.



DVD Picture Adjustment Screen

ADVUNI400CP

Direct Entry

When the Direct Entry icon is touched the Direct Entry Screen appears. The user can manually select a title or a chapter. By touching ▼ icon, the user can select a chapter or title. The title or chapter can be selected by touching the corresponding number for a title or chapter. After entering the numbers, touch the OK icon. If a wrong digit is entered, touching the arrow will remove the number. After touching OK, playback will begin.

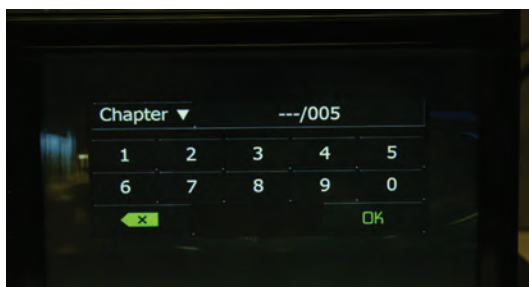

DVD Chapter and Title Direct Entry Screen

Inserting a Disc

Upon inserting a DVD disc, DVD mode is entered and disc play begins. A disc cannot be inserted if there is already a disc in the unit or if the power is off.

Note: If Parental Lock (Rating) is activated and the disc inserted is not authorized, the 4-digit code must be entered and/or the disc must be authorized.

Note: DVD-R and DVD-RW will not play unless the recording session is finalized and the DVD is closed.

Ejecting a Disc- Press the Eject (▲) button on the front of the unit to eject the disc. The unit automatically reverts to Tuner mode. You may eject a disc with the unit powered off. The unit will remain off after the disc is ejected.

Resetting the Loading Mechanism - If the disc loads abnormally or an abnormal core mechanism operation occurs, press and hold the Eject (▲) button on the front of the unit to reset the loading mechanism. Normal operation resumes.

Accessing DVD Mode - To switch to DVD mode when a disc is already inserted, touch **SRC** on the TFT LCD screen to access the source menu. Touch the disc icon.

ADVUNI400CP

Multi-Language Discs (DVD Only)

Changing Audio Language - If you are watching a disc recorded in multiple languages, touch the TFT LCD screen, then touch AUDIO to choose a language. Each time the icon is touched the language will change.

Changing Subtitle Language - If you are watching a disc recorded in multiple languages with subtitles, touch the TFT LCD, then touch Language screen to choose the language that you would like the subtitles to appear.

Playback Information

During DVD and VCD playback, touch the TFT LCD screen to display playback information on the screen, including the current playback time.

DVD Playback Information

- DVD Video – Format of current disc.
- Time 00:01:30/00:36:10 – Indicates the playback time of the current track.
- Title 5/08 – Indicates the fifth of 8 titles on the DVD is currently playing.
- Chapter 2/16 – Indicates that the second of 16 chapters on the DVD is currently playing.





VCD Playback Information

- VCD2.0 – Format of current disc.
- Time 00:01:30/00:36:10 – Indicates the playback time of the current track.





ADVUNI400CP

General Disc Information

Disc Properties

Symbol	12cm Disc Properties	Max Play Time
	Single side single layer (DVD-5)	(MPEG 2 Method)
	Single side double layer (DVD-9)	133 minutes
	Double side single layer (DVD-10)	242 minutes
	Double side double layer (DVD-18)	266 minutes
		484 minutes
	Single side single layer (VCD)	(MPEG 1 Method)
		74 minutes
	Single side single layer	74 minutes

Disc Symbols

Symbol	Meaning
	Number of voice languages recorded. The number inside the icon indicates the number languages on the disc (maximum of 8).
	Number of subtitle languages available on the disc (maximum of 32).
	Number of angles provided (maximum of 9).
	Aspect ratios available. "LB" stands for Letter Box and "PS" stands for Pan/Scan. In the example on the left, the 16:9 video can be converted to Letter Box video.
	Indicates the region code where the disc can be played. <ul style="list-style-type: none"> • Region 1: USA, Canada, East Pacific Ocean Islands • Region 2: Japan, Western Europe, Northern Europe, Egypt, South Africa, Middle East • Region 3: Taiwan, Hong Kong, South Korea, Thailand, Indonesia, South-East Asia • Region 4: Australia, New Zealand, Middle and South America, South Pacific Ocean Islands/Oceania • Region 5: Russia, Mongolia, India, Middle Asia, Eastern Europe, North Korea, North Africa, North-West Asia • Region 6: Mainland China • ALL: All Regions

ADVUNI400CP

CD Operation

From the Main Menu Screen touch the DISC icon or insert a CD into the disc slot, label side up. Playback begins in CD mode when a disc is inserted correctly.

CD Main Menu

The on-screen icons and touch key areas are outlined below.

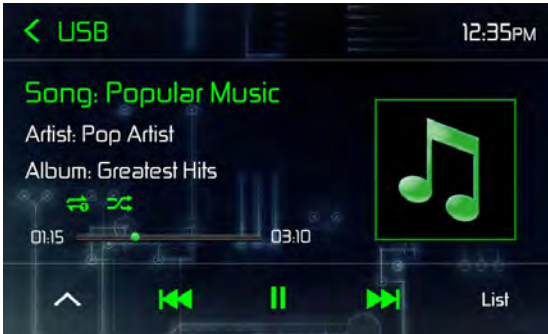

CD/USB Main Menu

SRC Icon - Touch this icon to return to the Main Menu Screen.

DISC - Displays the current source.

Track Number- Lists the current track playing and the total number of tracks contained on the disc.

Time Display - This indicator displays the time as entered by the user in the Settings Menu.

CD Disc Information Display - Displays the artist, the title of the track and the title of the album.

More (▼/▲) - Touch the ▼/▲ icons to display the next or previous page of the Disc menu.

(◀◀) Previous - Touch this icon to play the previous track.

(▶/||) Play/Pause - Touch this icon to begin disc playback. Touch this icon again to pause disc playback.

(▶▶) Next - Touch this icon to play the next track.

ADVUNI400CP

List - Touch this icon to access the list of tracks contained on the disc. Touch a desired track icon twice and the track will begin playing.

() **Shuffle** - Touch this icon to play tracks in the directory in a random order. The icon will light on the main CD screen.

() **Repeat** - Touch this icon to repeat playback of the current track. The icon on the TFT LCD screen will light and small number 1 will appear below the icon and the track will repeat. Touch this icon a second time and the album will repeat. The icon on the TFT LCD screen will light and small letter a will appear below the icon and the album will repeat. Touch the icon again the repeat function will be cancelled. The icon on the TFT LCD screen will dim and playback of the remainder of the disc will resume.

() **Equalizer** - Touch this icon to access the Equalizer Control Menu. (See "Adjusting Equalizer Controls")

Direct Entry - Touch this icon to the display the Direct Entry Screen.

Track Elapsed Playback Time - The elapsed playback time of track is displayed on the on the TFT LCD screen.

Track Total Playback Time - The total playback time of track is displayed on the main CD screen.

ADVUNI400CP

CD List

Touching the List icon will display the CD List Screen. The CD List Screen illustrates the contents of a CD disc. The contents are divided into folders and various file types. Touching the icon will display the files present on the disc.



CD List Screen

(🎵 **Audio Files** - Touch the audio file icon to display the audio file. Touch the audio file icon to select a track. Touch the audio file icon again to confirm and playback will begin.

(🎞️ **Video Files** - Touch the video file icon to display the video file. Touch the video file icon to select a video file. Touch the video file icon again to confirm and playback will begin.

(🖼️) **Image Files (JPEG etc)** - Touch the image icon to display a folder or individual JPEG file. Touch the image icon to select a folder or an individual JPEG file. In the case of a JPEG folder touch the folder icon twice and the contents of the folder will be displayed. Touch the JPEG image icon to select and view an individual JPEG file.

(📁) **Folders** - Touch the icon to display the folder/file hierarchy. Touch the folder icon twice and the contents of the folder will be displayed. Touch the file icon to select a file. Touch the icon again to confirm and open the file.

ADVUNI400CP

Track Direct Entry

When the Direct Entry icon is touched the Direct Entry Screen appears. The user can manually select a track by touching the corresponding number. After entering the track numbers touch the OK icon. If a wrong digit is entered touching the arrow will remove the number. After touching OK playback will begin.



CD Track Direct Entry Screen

Controlling Playback

Inserting a Disc - Upon inserting a CD, disc play begins. You cannot insert a disc if there is already a disc in the unit or if the power is off.

Ejecting a Disc - Press the Eject (▲) button on the front of the unit to eject the disc. The unit automatically reverts to Tuner mode. You may eject a disc with the unit powered off. The unit will remain off after the disc is ejected.

Resetting the Loading Mechanism - If the disc loads abnormally or an abnormal core mechanism operation occurs, press and hold the Eject (▲) button on the front of the unit to reset the loading mechanism. Normal operation resumes.

Pausing Playback - Touch the Play/Pause (▶/||) icon to suspend or resume disc play.

Moving Through Tracks - Touch the Next (▶▶) icon to advance to the next track on the disc. Touch the Previous (◀◀) icon to move to the previous track.

Repeat Playback - Touch the ↺ icon to alter repeat mode according to the following:

- CD-DA: Repeat Track > Repeat Album > Repeat Off
- CD-R/RW: Repeat Track > Repeat Album > Repeat Off

Random Play Select - Touch the Random (⌘) icon to play the tracks on the disc in a random, shuffled order. Touch the Random (⌘) icon again to cancel Random Play mode.

Note: CD-R and CD-RW will not play unless the recording session is finalized.

ADVUNI400CP

MP3/WMA Operation

MP3 is a format for storing digital audio. An audio CD-quality song can be compressed into the MP3 format with very little loss of quality, while taking up much less space. Insert a MP3 Disc into the disc slot, label side up. Playback begins in MP3 mode when a disc is inserted correctly. The unit plays the songs in the order they were burned on to the disc. The menu for playing audio MP3 music files is the same as previously described for CD discs.

Media and File Requirements

This player allows you to play back MP3 and WMA files recorded onto CD-R/RWs, DVD+R/RWs, and DVD-R/RWs. For CD-RW discs, please make sure it is formatted using the full method and not the quick method to prevent illegal disc operation. For the greatest file capacity, Dual Layer DVD's can be used when burning music to a disc.

MP3 Format Compatibility

The file naming formats listed below are compatible with this unit:

- ISO 9660 – file name: 12 characters, file extension: 3 characters
- ISO 9660 – file name: 31 characters, file extension: 3 characters
- Joliet – 64 characters

If the file or folder name does not conform to ISO 9660 file system standards, it may not be displayed or played back correctly. Use the following settings when compressing audio data for your MP3 disc:

- Transfer Bit Rate: 128kbps
- Sampling Frequency: 48kHz

When recording MP3 up to the maximum disc capacity, disable additional writing. For recording on an empty disc up to maximum disc capacity, use the "Disc at once" setting.

MP3 Playing Order

When selected for play, files and folders are accessed in the order they were written by the CD writer. As a result, the order in which they are expected to be played may not match the order in which they are actually played. You may be able to set the order in which MP3/WMA files are to be played by writing them onto a medium such as a CD-R with their file names beginning with play sequence numbers such as "01" to "99".

ADVUNI400CP

Controlling Playback

Inserting a Disc - Upon inserting a MP3/WMA disc, disc play begins. You cannot insert a disc if there is already a disc in the unit or if the power is off.

Ejecting a Disc - Press the Eject (▲) button on the front of the unit to eject the disc. The unit automatically reverts to Tuner mode. You may eject a disc with the unit powered off. The unit will remain off after the disc is ejected.

Resetting the Loading Mechanism - If the disc loads abnormally or an abnormal core mechanism operation occurs, press and hold the Eject (▲) button on the front of the unit to reset the loading mechanism. Normal operation resumes.

Playing MP3/WMA Files - After inserting a MP3/WMA disc, files will play in the sequence of the "Root" directory.

Note: When burning MP3 / WMA files onto a DVD disc, use folders when burning large numbers of songs / files to a disc for easy music navigation. Select the "Disc at Once" option and close your disc.

Note: CD-R and CD-RW will not play unless the recording session is finalized.

Pausing Playback - Touch the Play/Pause (▶||) icon to suspend or resume playback.

Moving Through Tracks - Touch the Next (▶▶) icon to advance to the next track. Touch the Previous (◀◀) icon to move to the previous track on the MP3 disc.

Repeat Playback - Touch the Repeat (↺) icon to alter repeat mode as follows: Repeat Single > Repeat Folder > Repeat All > Repeat Off.

Random Play Select - Touch the Random (⌘) icon to play the tracks on the MP3 disc device in a random, shuffled order. Touch the Random (⌘) icon again to cancel Random Play mode.

ADVUNI400CP

RADIO TUNER OPERATION

From the main menu screen touch the radio icon. The radio tuner display screen appears.

Radio Tuner TFT Display

The on-screen icons and touch key areas are outlined below.



Radio Tuner TFT Display Screen

SRC Icon - Touch to view the SOURCE MENU and select a new playback source.

Radio - Displays the current source.

Time Display - This indicator displays the time as entered by the user in the Settings Menu.

Preset List - Provides a display of the preset frequencies. Touch to recall a preset station. The radio can store 6 FM1, 6 FM2, 6 FM3, 6 AM1, and 6 AM2 frequency presets.

Local / Distance - Displays the Local/Distance setting.

RT (Radio Text) - Allows a radio station to transmit a 64-character free-form text that can be either static (such as station slogans) or in sync with the programming (such as the title and artist of the currently playing song).

PS (Program Service) - An eight-character static display that represents the call letters or station identity name. Most RDS capable receivers display this information. Touch "PS" or "RT" to alternate between RT / PS / PTY feature.

Stereo - Displays stereo radio signal reception.

FM1 - Displays the current preset frequency band.

P1 through P6 - Displays the current preset frequency within the preset frequency band that currently playing.

107.7 MHz - Displays the radio station frequency that is currently playing.

ADVUNI400CP

More (▼/▲) - Touch the ▼/▲ icons to display the next or previous page of the Radio menu.

(◀◀) Seek Down / Manual Seek - Touch this icon to seek the previous available radio station. Touch and hold this icon (Until "Manual Seek -" is displayed) to manually tune the radio in increments. Default Seek Down mode is resumed after 5 seconds of inactivity.

(AS) Auto Store - Touch to automatically search and store all strong stations.

(▶▶) Seek Up / Manual Seek - Touch this icon to seek the next available radio station. Touch and hold this icon (Until "Manual Seek +" is displayed) to manually tune the radio in increments. Default Seek Up mode is resumed after 5 seconds of inactivity.

Band - Touch to change between AM/FM bands.

Option - Touch this icon to display the Options screen.

Save - Touch this icon to save a radio station frequency in one or all six preset stations on FM band 1, 2, 3 or AM band 1 and 2.

Local (LO) / Distance (DX) - Touch to select and activate local and distance station reception. When the Local function is on, only radio stations with a strong radio signal are tuned in.

Direct Entry - Touch this icon to the display the Direct Entry Screen.

(EQ) Equalizer - Touch this icon to access the equalizer control menu. (See "Adjusting Equalizer Controls")

Option Screen

Touching the Options icon will display RDS, CT and PTY function options.



Radio Tuner Option Screen

ADVUNI400CP

RDS ON/OFF - Radio Data System (RDS) is a communications protocol standard for embedding small amounts of digital information in conventional FM radio broadcasts.

CT ON/OFF - (Clock Time) Some stations broadcast the time and date within the encoded RDS signal. The clock time is automatically adjusted when 'CT' is set to 'ON'.

Note: Stations broadcasting close to time zones may not broadcast the correct time in your particular area. In this case, turn CT Off and manually set the time.

PTY - The Program Type (PTY) function displays the program category of the current station such as category (news, sports, talk etc.) Use the scroll bar to select various categories. Touching the Back icon returns the user to main tuner screen.



PTY Screen

There are 27 categories in the PTY function.

1. None	8. Adult Hits	15. Jazz	22. Personality
2. News	9. Soft Rock	16. Classic	23. Public
3. Info	10. Top 40	17. RGB	24. College
4. Sports	11. Country	18. Soft RGB	25. Weather
5. Talk	12. Oldies	19. Language	26. Test
6. Rock	13. Soft	20. Religious Music	27. Alert
7. Classic Rock	14. Nostalgia	21. Religious Talk	

ADVUNI400CP

Direct Entry Tuning

When the Direct Entry icon is touched the Direct Entry Screen appears. The user can enter the desired radio station frequency using the on-screen number pad. After entering the radio station frequency touch the OK icon. If a wrong digit is entered touching the green arrow will remove the number. After touching OK the radio will tune to the entered station. Playback will begin.



Radio Direct Entry Screen

Using Preset Stations

Six numbered preset icons store and recall stations for each band. All six stored stations (P1 through P6) for the current band appear on the screen.

Storing a Station

1. Select a band (if needed), then tune to a desired radio station frequency.
2. Touch the on-screen Save icon. The following screen will appear.

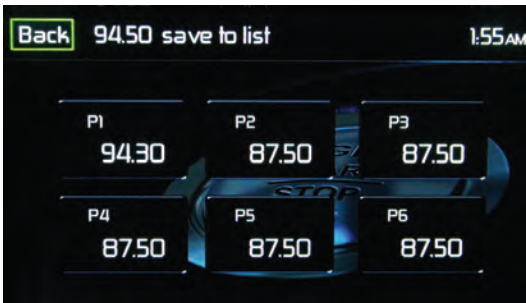

Preset Save Screen

ADVUNI400CP

3. Touch the preset number in which you would like to store the current station. The station frequency is displayed at the top of the menu. The preset number will appear highlighted. The station frequency will be stored in the highlighted preset. The station will be displayed Tuner TFT LCD screen. Station can also be stored by touching and holding the preset icon to store the station currently tuned as a preset.

Recalling a Station

1. Select a preset band (if needed).
2. Touch an on-screen preset icons (P1 through P6) to select the corresponding stored station.



Preset Station Screen

Auto Store (AS)

To select six strong stations and store them in the current band. This feature is most useful when travelling in an area where you are not familiar with the local stations.

1. Select a band (if needed).
2. Touch the AS icon to activate the Auto Store function. FM Band 1 will be filled if enough stations are detected. The AM Bands function in a similar manner. As new stations are found they will replace stations already stored in that band.

Note: If stations have already been set as favorites, activating the Auto-Store feature will erase those stations and enter the new strong stations.

Local (LOC) / Distance (DX) Settings

When the Local function is on, only radio stations with a strong radio signal are played. To activate the Local function in the AM/FM tuner mode, touch "More" on the Tuner user interface (UI) screen. The Local/Distance icon is displayed. Touch Local / Distance to turn the function ON or OFF. When the Local or Distance function is active, the Local / Distance text in the UI is displayed.

ADVUNI400CP

USB OPERATION

The unit will read the audio/video files on USB devices automatically.

NOTE: The USB port will recognize most USB flash memory devices and portable hard drives. Hard drives must be formatted to FAT32. NTFS is not supported.

Inserting / Removing a USB Device

To insert a USB device:

1. Locate the Interface Cover on the front of the radio.

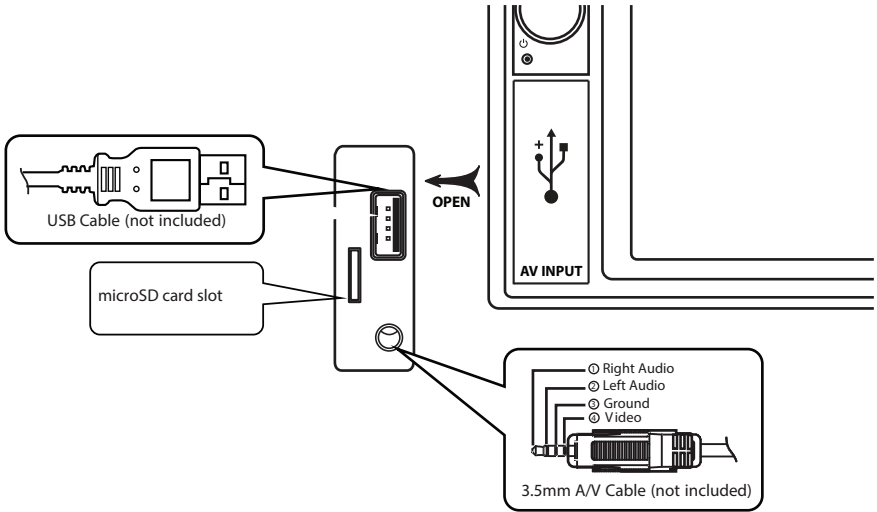

USB Slot and microSD Card Slot Location

2. Lift the protective cover to reveal the USB slot.
3. Insert the USB device into the USB port.

Note: The microSD card is used for navigation only. Do not modify/delete any files.

ADVUNI400CP

USB Operation From the main menu screen touch the USB icon.

USB Main Menu

The on-screen icons and touch key areas are outlined below.

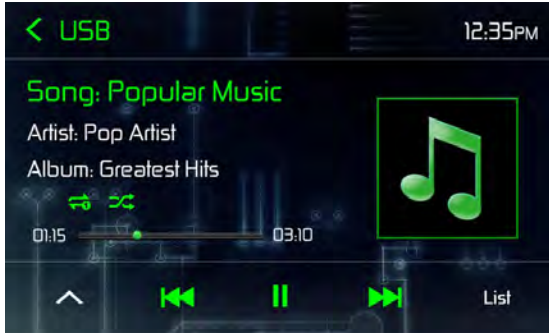

USB Main Menu

SRC Icon - Touch this icon to return to the Main Menu Screen.

Scrolling Display - Displays current track information.

Track Number - Lists the current audio track playing and the total number of audio tracks in audio mode. Lists the current video folder and the total number of video folders in video mode.

Time Display - This indicator displays the time as entered by the user in the Settings Menu.

More (▲/▼) - Touch the ▲/▼ icons to display the next or previous page of the USB menu.

(⏮) Previous - Touch this icon to play the previous track.

(▶/⏸) Play/Pause - Touch this icon to begin playback. Touch this icon again to pause playback.

(⏭) Next - Touch this icon to play the next track.

ADVUNI400CP

List - Touch this icon to access the list of audio and video files contained on the USB device. Touch a folder icon and the contents of the folder will be displayed. Touch a desired track icon twice and the track will begin playing.

() **Shuffle** - Touch this icon to play audio or video tracks in a random order. The icon will be displayed on the TFT.

() **Repeat** - In audio mode touch this icon to repeat playback of the current audio track. The icon on the TFT will be displayed and a small letter "A" will appear below the icon and ALL audio tracks will repeat. Touch this icon again and the current track will repeat (Single track). The icon on the TFT will display and small number "1" will appear below the icon. Touch the icon again and the repeat function will be cancelled.

In video mode touch this icon during playback to repeat the current track. The icon on the TFT will display and small number "1" will appear below the icon and the track will repeat. Touch the icon again to repeat all the tracks. The icon on the TFT will display and a small letter "A" will appear below the icon and all the tracks will repeat. Touch the icon again the repeat function will be cancelled.

() **Equalizer** - Touch this icon to access the Equalizer Control Menu. (See "Adjusting Equalizer Controls")

Direct Entry - Touch this icon to the display the Direct Entry Screen.

ADVUNI400CP

USB List

Touching the "List" icon will display the USB List Screen. The USB List Screen displays the audio and video files present on the USB device. The contents are divided into folders and various file types. The file types consist of audio and video files. Touching the folder icon will display the files present in the folder.



USB List Screen

(🎵) **Audio Files** - Touch the audio file icon to display the audio file. Touch the audio file icon to select a track. Touch the audio file icon again to confirm and playback will begin.

(📺) **Video Files** - Touch the video file icon to display the video file. Touch the video file icon to select a video file. Touch the video file icon again to confirm and playback will begin.

(🖼️) **Image Files (JPEG etc)** - Touch the image icon to display the image file. Touch the image file icon to select an image file. Touch the image file icon again to confirm and view the image.

(📁) **Folders** - Touch the icon to display the folder/file hierarchy. Touch the folder icon and the contents of the folder will be displayed. Touch the file icon to select a file. Touch the icon again to confirm and open the file.

ADVUNI400CP

Direct Entry

When the Direct Entry icon is touched the Direct Entry Screen appears. The user can manually select a track by touching the corresponding number. After entering the track numbers touch the OK icon. If a wrong digit is entered use the arrow/backspace key to remove the number. After touching "OK" playback will begin.



USB Track Direct Entry Screen

Moving Through Tracks

Touch the Next (▶▶) icon to advance to the next track on the USB device.

Touch the Previous (◀◀) icon to move to the previous track on the USB device.

Pausing Playback

Touch the Play/Pause (▶||) icon to suspend or resume playback.

PIC - When the PIC icon is touched the "Picture Adjust" screen appears. Touch this icon during playback to adjust the brightness, contrast, saturation and hue. These levels can be adjusted to suit user preferences. The adjustments are accomplished by touching the + or - icons to decrease or increase the desired setting. The settings have range of 1 to 20.



USB Picture Adjust Screen

Note: The Picture Adjustment Screen will turn OFF automatically if no adjustment is made within five seconds or if any other part of the screen is touched.

ADVUNI400CP

iPod® / iPhone® Controls

Accessing iPod® Mode

The user can control an iPod®/iPhone® using the touch screen to access, albums, songs, etc.

The unit will automatically switch to iPod® mode when an iPod®nano, iPod® touch or iPhone® is plugged into the front panel USB connector. Also the iPod® can be accessed from the Main Menu Screen by touching the iPod® icon (only available when an iPod® or iPhone® is connected to the front panel USB connector).

iPod® / iPhone® Main Menu

The on-screen icons and touch key areas are outlined below.



iPod®/iPhone® Main Menu

SRC Icon - Touch this icon to return to the Main Menu Screen.

iPod - Displays the current source.

Track Number - Lists the current audio track playing and the total number of audio tracks in audio mode. Lists the current video folder and the total number of video folders in video mode.

Time Display - This indicator displays the time as entered by the user in the Settings Menu.

More (▲/▼) - Touch the ▲/▼ icons to display the next or previous page of the iPod® menu.

ADVUNI400CP

(⏮) **Previous** - Touch this icon to play the previous track.

(▶/⏸) **Play/Pause** - Touch this icon to begin playback. Touch this icon again to pause playback.

(⏭) **Next** - Touch this icon to play the next track.

List - Touch this icon to access the list of audio and video files contained on the iPod®. Touch a folder icon and the contents of the folder will be displayed. Touch a desired track icon twice and the track will begin playing.

(🔀) **Shuffle** - Touch this icon to play audio or video tracks in a random order. The icon will light on the main TFT LCD screen.

(🔄) **Repeat** - In audio mode touch this icon to repeat playback of the current audio track. The icon on the TFT will display and a small letter "A" will appear below the icon and the all the audio tracks will repeat. Touch this icon again and single track will repeat. The icon on the TFT will display and small number "1" will appear below the icon. Touch the icon again the repeat function will be cancelled. The icon on the main TFT LCD screen will dim and playback of the remainder of the tracks will resume.

(EQ) **Equalizer** - Touch this icon to access the Equalizer Control Menu. (See "Adjusting Equalizer Controls")

Direct Entry - Touch this icon to the display the Direct Entry Screen.

iPod® List

Touching the List icon will display the iPod® List Screen. The iPod® List Screen illustrates the audio and video files present in the iPod®. The contents are divided into folders and various file types. The file types consist of audio and video file. Touching the folder icon will display the files present in the folder.



iPod®/iPhone® List Screen

ADVUNI400CP

(🎵) **Audio Files** - Touch the audio file icon to display the audio file. Touch the audio file icon to select a track. Touch the audio file icon again to confirm and playback will begin.

(🖼️) **Image Files (JPEG etc)** - Image files are selected and controlled by the iPod®.

(📁) **Folders** - Touch the icon to display the folder/file hierarchy. Touch the folder icon and the contents of the folder will be displayed. Touch the file icon to select a file. Touch the icon again to confirm and open the file.

Controlling Playback

Direct Entry

When the Direct Entry icon is touched the Direct Entry Screen appears. The user can manually select a track by touching the corresponding number. After entering the track numbers touch the OK icon. If a wrong digit is entered touching the arrow will remove the number. After touching OK playback will begin.

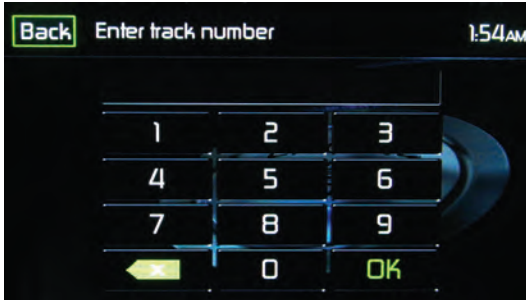

iPod®/iPhone® Track Direct Entry Screen

Moving Through Tracks

Touch the Next (▶▶) icon to advance to the next track on the iPod®.
Touch the Previous (◀◀) icon to move to the previous track on the iPod®.

Pausing Playback

Touch the Play/Pause (▶||) icon to suspend or resume playback.

ADVUNI400CP

Connecting External Devices

AV In 1 / AV In 2

AV In 1

AV In 1 is used for playback of audio/video from an external device connected to the unit through a 3.5mm jack located on the front panel. The unit can increase or decrease the volume of the connected device. All other controls are done on the connected device.



AV In 1 Screen (No Signal)

AV In 2

AV In 2 is used for playback of audio/video from an external device connected through RCA connectors located on the back of the unit. The unit can increase or decrease the volume of the connected device. All other controls are done on the connected device.



AV In 2 Screen (No Signal)

NOTE: Audio/Video devices must be connected to this unit using an audio/video adapter cable that is available separately.
NOTE: Video will only play when the vehicle parking brake is engaged. The parking brake wire must be connected for this feature to operate.

ADVUNI400CP

Using a Smartphone via Screen Mirroring

What is HDMI/MHL (Screen Mirroring)? HDMI (High Definition Multimedia Interface) is a digital interface for audio and video sources. HDMI is a digital replacement for analog video standards.

Mobile High-Definition Link (MHL) is an industry standard for a mobile audio video interface that allows consumers to connect mobile phones, tablets, and other portable consumer electronics (CE) devices to high-definition televisions (HDTVs) and mobile multimedia receivers.

Screen Mirroring allows you to use the multimedia TFT touch screen to control your mobile device.

Note: It may not be legal to view apps on a smartphone while driving or controlling a vehicle. It is the drivers responsibility to obey local and federal laws while driving or controlling a vehicle.

Interfacing your Smartphone - Android

Depending on your model and brand of smartphone Screen Mirroring may not be supported. Check your smartphone documentation for supported features. Android smartphones will require an app that must be downloaded from Google Play Store. Search for "Advent Screen Mirroring" in the search bar.

Note: In order to connect your smartphone to your ADVUNI400CP, you will need an HDMI/MHL adapter for your particular brand of smartphone. In some cases, you may need to connect the additional micro USB port (On the adapter itself) to a power source in order for the HDMI/MHL adapter to function properly.

Smartphone HDMI/MHL adapters are available at your local mobile phone retailer. For example, if you have a Samsung S3/S4 or Note 2, you would buy the below HDMI/MHL adapter:

Samsung ET-H10FAUWESTA Micro USB to HDMI
1080P HDTV Adapter Cable

For Samsung Galaxy S3/S4 and Note 2

Smartphone brands are usually only compatible with the same brand of HDMI / MHL adapter.

ADVUNI400CP

Interfacing your Smartphone - iPhone 7® / iPhone 7 Plus® / iPhone 6® / iPhone 6 Plus® / iPhone 5® / iPhone 5S® / iPhone 5C®

Note: In order to connect your smartphone to your ADVUNI400CP, you will need the "Apple Lightning Digital AV Adapter" (HDMI adapter). No app or software is needed for Apple devices.

Apple adapters are available at your local Apple retailer.

Mirror Mode (Android and Apple Devices)

Mirror Mode allows the image from the smartphone to be displayed on the larger head unit screen. There is no touch screen control from the head unit screen. You must control the apps from the smartphone.

Mirror Mode w/ Touch Screen Control (Android Only)

Mirror Mode w/ Touch Screen control allows the image from the smartphone to be displayed on the larger head unit screen as well as full touch screen control of the smartphone screen from the head unit.

Note: All apps may not be supported / displayed when connected via Screen Mirroring.

General

1. Some devices (smartphones) may not be compatible with HDMI/MHL connectivity.
2. Incoming calls or messages may pause media output. Media will resume after the call or message.
3. Simultaneously running multiple apps on your smartphone while screen sharing places heavy demand on the smartphone, potentially affecting its performance. Close unused apps on your smartphone to enhance the screen sharing feature of the ADVUNI400CP.
4. If you are having trouble seeing your smartphone display on the head unit screen, try connecting your smartphone (With HDMI/MHL adapter) to another device such as a flat panel TV with HDMI input. If you cannot see the smartphone display on the flat panel TV, the smartphone does not support Screen Mirroring.

ADVUNI400CP

Connecting Your Smartphone to the ADVUNI400CP

1. Advent Screen Mirroring App Installation Procedure

Download and install the Advent Screen Mirroring app from Google Play onto your smartphone.

2. Smartphone / Head Unit Bluetooth Connection

In order to have full touch screen control from the head unit screen (via the Screen Mirroring app), a Bluetooth connection is required between your smartphone and head unit. Refer to the head unit / smartphone documentation for further information on pairing / connecting devices.

3. Connect Your Smartphone

Most Android smartphones will require an HDMI/MHL adapter in addition to an HDMI cable with 2 Type A male connectors. These adapters are available at smartphone retail stores. See head unit documentation for more information about HDMI/MHL adapters. Connect your smartphone to the HDMI/MHL adapter. Connect one end of the HDMI cable to the HDMI/MHL adapter. Connect the remaining end of the HDMI cable to the Advent multimedia head unit HDMI input (Rear chassis panel). Consult your smartphone documentation for instructions on how to access HDMI/MHL on your device.

4. Touch Screen Calibration Start

Launch the Screen Mirroring app on your smartphone. Using the head unit touch screen, go to Settings in the Screen Mirroring app. Scroll down slightly, and press the Touch Screen Calibration "Start" button.

5. Touch Screen Calibration

Once the touch screen is calibrated, scroll up, and press System Settings to return to the main Screen Mirroring page. Press Mobile Home Page to access your smartphone from the touch screen of the Advent multimedia head unit. Touch the Car Home Page to return to the Main Source Menu of the head unit. This calibration is performed once per phone when initially set-up.

ADVUNI400CP

DMH25J HDMI WiFi Adapter

Mirror Mode (One -Way Control - Apple / Android)

Mirror Mode does not need any app support. Simply connecting the DMH25J to the ADVUNI400CP and establishing a WiFi connection is all that is needed.

Mirror Mode w/ Touch Screen Control (Two-Way Control - Android Only)

Mirror Mode w/ Touch Screen Control will require an app to be downloaded from Google Play Store. Search for "Advent Screen Mirroring" app.

Bluetooth Connection for Two-Way Control

Once the Advent Screen Mirroring app is downloaded;

1. Establish a Bluetooth connection between your smartphone and the ADVUNI400CP.
2. Open the Advent Screen Mirroring app on your smartphone.
3. Open the Settings Menu in the Screen Mirroring app and press Touch Screen Calibration "Start" button.
4. Following the on-screen prompts.
5. Once the touch screen is calibrated, press System Settings to return to the main Screen Mirroring page.
6. Press "Home Page" to access your smartphone screen.

Please refer to the instructions that come with the DMH25J for installation and connectivity information.

Notes and information on DMH25J installation;

1. **External power from a USB connector or other source of 5VDC needs to be provided to the DMH25J. The full size USB to microUSB cable that is included with the DMH25J can be used for external power.**
2. Try and locate the DMH25J as far away as possible from metal objects in the vehicle. The DMH25J is a transceiver and close proximity to metal and other objects may affect its performance.

ADVUNI400CP

BLUETOOTH OPERATION

NOTE: The line-of-sight distance between this unit and your mobile phone must be 8 feet (2.4 meters) or less for sending and receiving voice and data via Bluetooth wireless technology.

Please make sure your mobile phone supports Bluetooth. (Headset or Handsfree profiles or both and A2DP). Adhere to the following guidelines for successful operation.

- Before using Bluetooth functions, you must pair your mobile phone to the ADVUNI400CP unit (see "Pairing the Your Mobile Phone with the Unit". To ensure the best reception for pairing and re-connection, please make sure the mobile phone battery is fully charged before you begin.
- Try to perform pairing within a few minutes of the mobile phone being turned on.
- Once the unit has been paired with the mobile phone, the unit's model number, "ADVUNI400CP", will be displayed on the mobile phone.
- To achieve the best performance, always keep the mobile phone within 10 feet (3 meters) of the unit.
- Always keep a clear path between the mobile phone and the unit. Never place a metal object or any other obstacle between the mobile phone and the unit.
- Some mobile phones may have a "Power Saving Mode" option. PLEASE DO NOT use the power saving mode with the ADVUNI400CP.
- Before accepting or making a call, make sure your mobile phone's "Bluetooth function" is turned on.
- To ensure the best conversation quality/performance, stay within 3 feet (1 meter) of the unit's microphone when talking.
- To manually disconnect the mobile phone from the unit, touch the "Chain Link" icon on the Bluetooth user interface (next to the mobile phone name) and the Bluetooth device will be "disconnected", but still paired.

ADVUNI400CP

Bluetooth User Interface

The on-screen icons and information for Bluetooth functions are outlined below:

SRC Icon - Touch this icon to return to the Main Source Menu Screen.

Bluetooth - Displays the current source.

LG VX9200 - Indicates the device that is paired with the unit.

ADVUNI400CP Device Name - Provides the name that will appear on the Bluetooth device.

Scan - Touch the icon to search for Bluetooth devices.

Settings - Touch to display the Bluetooth Options page.

ADVUNI400CP

The user can make or receive phone calls with Bluetooth enabled phones through the unit. The user can also listen to music from a Bluetooth enabled device.

Pairing Bluetooth Devices

To connect your Bluetooth phone to the unit, the user needs to pair the phone to the unit. Pairing only needs to be done once per phone. **The user can pair up to five (5) phones.** Use your mobile phone to begin the Bluetooth pairing process.

1. Touch the MENU on the front panel to access the source menu.
2. Touch the Bluetooth icon on the source menu and the Bluetooth user interface screen will appear.
3. Touch the Settings icon.
4. On the Settings sub-menu set the Bluetooth function to ON.
5. On the Settings sub-menu set the Auto Connect function to ON.
6. Set the mobile phone Bluetooth discover mode to ON.

Note: Some discovery modes have a time limit, usually a minute, before they are automatically turned OFF.

7. Touch the "Scan" icon on the unit's Bluetooth user interface screen. Available devices will appear with the "Pair" icon next to it.

ADVUNI400CP



8. Touch the "Pair" icon on the unit's Bluetooth user interface screen.
9. A prompt to pair should appear on your mobile phone. Accept the request and initiate the process.
NOTE: Some mobile phones require a "pass key" or pairing code to connect. If your phone requires a pass key or pairing code, you will need to enter this number. The default pairing code for the ADVUNI400CP is "5309".
10. A prompt to enter a PIN number or passkey for the unit should appear. The default passkey for the unit is "5309".
11. At this point a prompt stating pairing successful should appear. Another prompt should appear asking connect to the unit, Yes or NO. Touch Yes. The mobile phone and the unit should connect. The mobile phone should display a message similar to "Device Connected" and the mobile phone and the unit are now connected. ADVUNI400CP will appear on the mobile phone list of devices.

Managing Incoming Calls

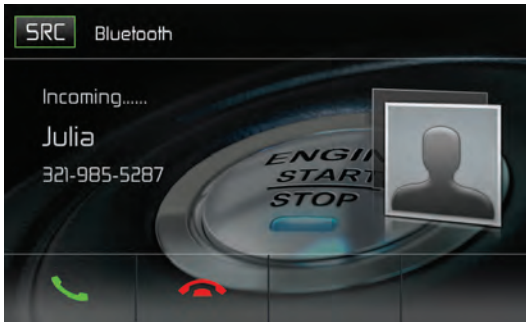
When connected to a Bluetooth mobile phone, the unit will mute audio output, pause CD play, and change to the Bluetooth screen below when a call is received. The incoming phone number or assigned name for that number will appear on the screen. An audible tone will sound from the unit and a graphic display will appear on the front panel.



Bluetooth Incoming Call Screen

1.  icon: Touch to answer an incoming call.
2.  icon: Touch to end an incoming call.

ADVUNI400CP

Making an Outgoing Call

Outgoing calls can be performed in two manners. The outgoing call can be direct dialed using the front panel keypad or the by touching either the Phonebook or Call History icons, selecting a name and touching the phone number.

Phonebook Synch / Importing Contacts / Call History

1. Select Bluetooth function (Handset icon) from the Bluetooth Home Menu.
2. Press "Option". Go to > "Phone Synch". Press "Synch" to import the mobile phone contacts. If you have many contacts, this may take up to 4-5 minutes initially. **Up to 2000 contacts can be imported.**

Direct Dialing:

1. Press the front panel MENU button and then touch the Bluetooth icon to access the Bluetooth main menu. The following screen will appear:

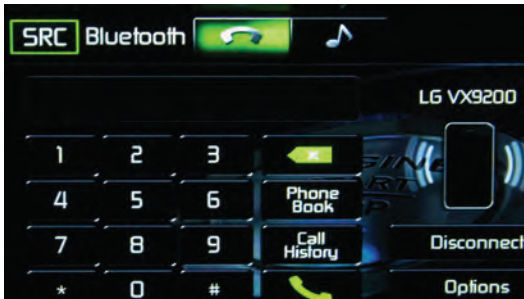

Bluetooth Direct Dial Screen

2. Use the 0-9, */+, and # icons to input the phone number. If necessary touch the green arrow icon to clear the last digit or the entire number and start over.
3. After entering the phone number, touch the handset icon to dial the call. The number dialed will be displayed on the screen.
4. To end the call, touch the handset icon.

Answering an Incoming Call

To answer an incoming call touch the handset icon. For best reception, speak loudly and clearly into the units microphone. To end the conversation, touch the handset icon.

Rejecting an Incoming Call

Touch the **Transfer to Phone** icon to reject an incoming call. The call will revert to your mobile phone and be left for voice mail.

Volume Control

To increase or decrease the volume level of an incoming call, turn the rotary knob on the front panel or press the VOL+/VOL- icons on the remote control.

ADVUNI400CP

Audio Mute

To mute the phone call audio from the unit when a call is received, press the front panel rotary knob. Press the front panel rotary knob again and phone call audio will be restored to the unit.

Call Log

The call log consists of dialed numbers, received calls and missed calls. **Note: Not all mobile phones allow access to missed, received or dialed calls and some will not allow uploading of your mobile phone's address book.**

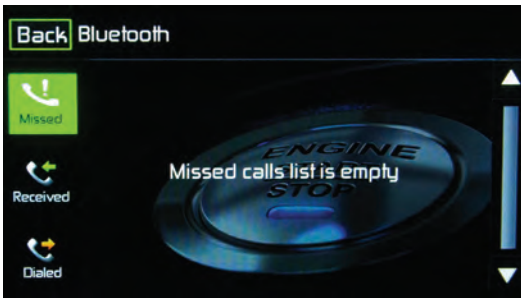

Bluetooth Call Log Screen

Missed Calls - The Missed Calls List retrieves the list of missed numbers from your mobile phone if your mobile phone allows the function. The last missed number is the first number on the list. Touch the Missed Calls menu option to view the list. To make a call from the Missed Calls list, touch the call's name. Touch the phone number and it will be dialed.

Received Calls - The Received Calls list retrieves the received numbers stored on your mobile phone if your mobile phone allows the function. To access the Received list, touch the Received Calls menu option. The last received number is the first number on the list. To make a call from the Received Calls list, touch the name. A new screen will appear with the name on the top and the phone number below. Touch the phone number and it will be dialed.

Dialed Calls - The Dialed Calls list retrieves the list of dialed numbers from your mobile phone if your mobile phone allows the function. The last dialed number is the first number on the list. Touch the Dialed Calls menu option to view the list. To make a call from the Dialed Calls list, touch the name. A new screen will appear with the name on the top and the phone number below. Touch the phone number and it will be dialed.

ADVUNI400CP

Call Transfer

While talking, to transfer audio from the unit back to the mobile phone, touch the **Transfer to Phone** icon. You can only transfer a call after it has been answered. Touching the **Transfer to Radio** icon will return the audio from the mobile phone to the unit. Touch the **Transfer Call** icon and the following screen will appear:



Transfer to Phone Screen



Transfer to Radio Screen

Call Transfer Screens

Bluetooth Music Function

Bluetooth provides A2DP (Advanced Audio Distribution Profile) profile for streaming music from a mobile phone or a portable multimedia player (PMP), sometimes referred to as a MP3 player. The unit allows you to play back audio files from your mobile phone using a Bluetooth connection.

Note: Please quit A2DP mode before attempting to make a phone call, as unexpected results may occur depending on your mobile phone model.

The unit can control a Bluetooth audio player via AVRCP (Audio/Video Remote Control Profile). Bluetooth audio players compatible with these profiles can be connected to this unit. The following screen is used for streaming music:

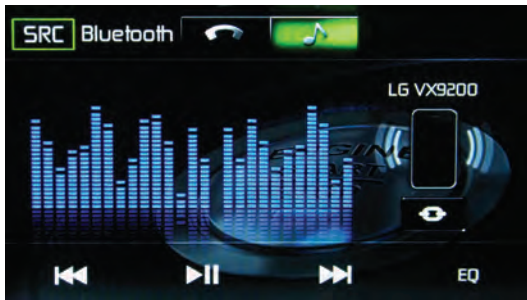

Bluetooth Audio Control Screen

ADVUNI400CP

While listening to audio the following functions are available:

1. Pause/Play (▶||) icon: Touch to pause playback. Touch again to resume playback.
2. Previous (◀◀) icon: Touch to play the previous track.
3. Next (▶▶) icon: Touch to play the next track.

Functionality varies depending on the profile used:

- A2DP: Stream audio from your Bluetooth compatible audio player and listen to the music through the unit.
- AVRCP: Play back, pause, select songs, etc. while streaming audio from your Bluetooth compatible audio player to the unit.

Note: Song information (e.g. elapsed playing time, song title, song index, etc. cannot be displayed on this unit. Since there are a number of Bluetooth audio players available on the market, operations with your Bluetooth audio player while using this unit may vary greatly. Please refer to the instruction manual that came with your Bluetooth audio player.

When there is an incoming call, the song will be paused. After the incoming call is finished, the screen will return to the music function screen and playback will continue.

Bluetooth Call While Navigating

When navigating and a Bluetooth call comes in, the user interface (UI) will automatically switch to the Bluetooth UI. To return to the navigation UI while the call is still in progress, press the **rotary encoder** button. The navigation UI will display and navigation voice prompts will be overridden by the phone call. When the call has ended, navigation voice prompts will return automatically.

Switching Between Sources While Navigating

Press the rotary encoder button to go back to the Main Source Menu when you are in Navigation mode. This will allow you to select another source (Radio, Disc, AV 1, etc). Press the **rotary encoder** button to switch back and forth between the currently selected source and the Main Source Menu.

PTT (Push to Talk) Function

The ADVUNI400CP has a PTT button to allow you to access Siri or Google Voice through the head unit when connected via Bluetooth. Your mobile phone must support Siri or Google Voice in order for this feature to be supported on the head unit. **NOTE: Samsung "S" Voice and other third-party apps may not be supported.**

ADVUNI400CP

REAR CAMERA OPERATION

This unit is “camera ready.” Before accessing any camera features, you must install a rear video camera.

When the camera is not installed and the function is accessed by the gear selector being placed in reverse or by the unit’s menu, the message “No Signal!” will be displayed and the following screen will appear.



Rear Camera Screen

When the camera is installed, the rear view image of what is behind the vehicle will appear when the vehicle is placed in reverse gear. When leaving reverse gear, the unit displays the previous screen.

ADVUNI400CP

SWC Ready

The built-in SWC Interface is compatible with PAC steering wheel control modules. The PAC SWI-RC is recommended.

A third-party adapter **must** be used in order for the ADVUNI400CP to be compatible with any steering wheel controls.

Note:

Not all OE steering wheel functions may be supported by the ADVUNI400CP. PTT - Will activate Siri / Google Voice if mobile phone supports the feature. Not compatible with all phones/vehicles.

The following controls are available for most vehicles:

1. Volume Up (+)	4. Preset (+)	7. Seek / Track +	10. BT Send
2. Volume Down (-)	5. Preset (-)	8. Seek / Track -	11. BT End
3. Mute	6. Source	9. Band	12. PTT

PAC SWI-RC Installation Hints

1. Set "Radio Select Switch". Set the SWI-RC to position 7 - "Pioneer/Other/Sony".
2. Programming - Use the Pioneer/Sony/Other radio function mapping order for Advent branded head units.
3. When programming the SWI-RC, if a function is not supported (or not desired), then the function **MUST** be skipped as per the PAC SWI-RC instructions.
4. The SWC function **MUST** be programmed in the correct order per the PAC SWI-RC radio function mapping order instructions.

SWI-RC (5VDC Reference)		
Function Mapping	Center Pin Voltage (Function Select)	Tip Pin Voltage
Volume +	H 5.0v	2.89
Volume -	H 5.0v	3.40
Mute	H 5.0v	1.37
Preset +	L 0.0v	2.15
Preset -	L 0.0v	2.56
Source	H 5.0v	0.79
Seek + / Track +	H 5.0v	2.15
Seek - / Track -	H 5.0v	2.56
Band	H 5.0v	3.94
BT Answer Call	L 0.0v	1.37
BT End Call	L 0.0v	1.79
PTT / Voice Activation	L 0.0v	3.94

ADVUNI400CP

PANDORA® MUSIC OPERATION

Pandora Music is available on your iPhone® / iPod® touch via USB cable or an Android™ device via Bluetooth. Data usage may occur.

Note: The Pandora Music app must be installed on your iPhone®/iPod® touch or Android device. For iPod®/ iPhone® connectivity, you can use the cable that comes with your Apple device for audio connectivity. To play Pandora Music using an Android device, it is necessary to pair your mobile phone via Bluetooth to the ADVUNI400CP. A cable connection for Pandora via Android is not supported.

Pandora Music

The on-screen indicators and touch key areas for Pandora Music functions are outlined below.

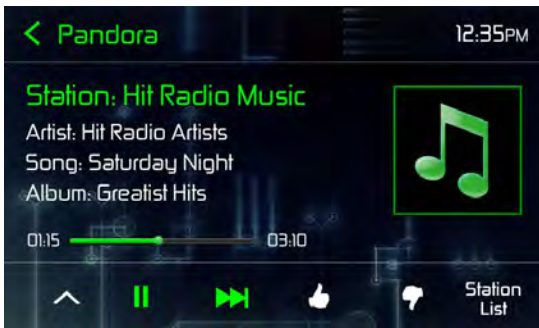

Pandora Radio User Interface Screen

SRC Icon - Touch this icon to return to the Main Menu Screen.

Pandora - Displays the current source.

Time Display - This indicator displays the time as entered by the user in the Settings Menu.

Pandora Music Information Display - Displays the Pandora station, artist, song, and album information.

Elapsed Time Indicator - Displays the elapsed and total playing time of the current track playing.

Pandora Preview Window - Displays album art, if available.

More ▲ - Touch to display the bookmark sub-menu.

ADVUNI400CP

(|| / ▶) **Pause / Play Icon** - Touch the || icon to pause playback. Touch the ▶ icon to begin playback.

(▶▶) **Next Icon** - Press this icon skip a song, subject to the skip limit.

(👍) **Thumbs Up** - Press thumbs up to tell Pandora® you like the track currently playing, and Pandora will play more tracks like it.

(👎) **Thumbs Down** - Press thumbs down to tell Pandora not to play this track. Pandora will skip to the next track. If the skip limit has been reached, Pandora will continue to play but your feedback will be recorded.

Station List Icon - Press this icon to access the Station List Screen.

Bookmark Sub-Menu

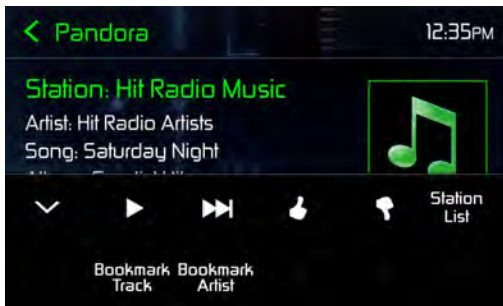

Pandora Bookmark Sub-Menu

Touch the Bookmark Track icon to bookmark a track.

Touch the Bookmark Artist icon to bookmark an artist.

Touch the More ▼ icon to return to the Pandora Music user interface screen.

ADVUNI400CP

Station List Screen

The Station List Screen allows you to search for music by stations you created.

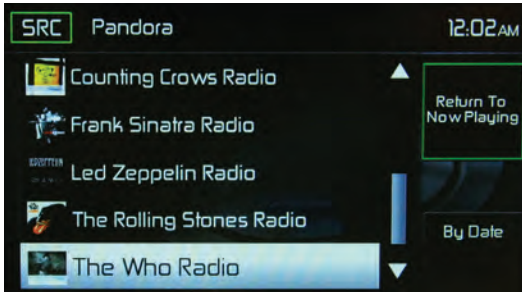

Pandora® Music Station List Screen

Touch a station on the list to choose that station.

Touch the Scroll Down (▼) icon to view the next page in the list or the Scroll Up (▲) icon to view the previous page.

Touch the Return to Now Playing icon to return to the Pandora Music user interface screen.

To Launch/Stop Pandora Music

1. Launch the Pandora app on the iPhone®, iPod® or Android device.
2. Touch the Pandora icon on the main menu screen. If only one device is connected to the radio, the Pandora Music user interface screen appears.

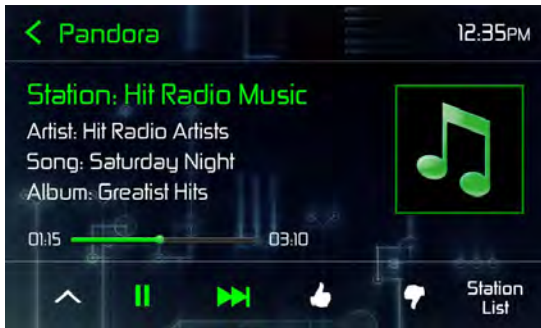

Pandora Music User Interface Screen

ADVUNI400CP

3. If both an Android and iPhone®/ iPod® device are connected to the radio, the select Android or Apple device screen appears.



Select Android or Apple device screen

4. To stop Pandora,® exit the Pandora app on the iPhone®, iPod® or Android device.

Pandora Error Messages		
Message Displayed	Cause	Corrective Action
BookMark Track Error	Software Error	The track could not be bookmarked, please try again in a moment.
BookMark Artist Error	Software Error	The song could not be bookmarked, please try again in a moment.
Thumbs Up / Down Error "Error Track Rating"	Software Error	Song feedback could not be sent, please try again in a moment.
No Active Station Error	Software Error	This account has no stations in it. Please visit Pandora.com and login to your account and add stations.
Skip Limit Reached	Software Error	Please note that Pandora limits skips to a maximum of six skips per station, per hour.

ADVUNI400CP

SiriusXM® RADIO OPERATION

Only SiriusXM® brings you more of what you love to listen to, all in one place. Get over 140 channels, including commercial-free music plus the best sports, news, talk, comedy and entertainment. Welcome to the world of satellite radio. A SiriusXM Vehicle Tuner and Subscription are required. For more information, visit www.siriusxm.com.

Activating SiriusXM® Radio

After installing your SiriusXM Connect Vehicle Tuner and antenna, power on your radio and select SiriusXM mode. You should be able to hear the SiriusXM preview channel on Channel 1.

After you can hear the Preview channel, tune to Channel 0 to find the radio ID of your tuner.

Note: The SiriusXM Radio ID does not include the letters I, O, S or F.

In the USA, you can activate online or by calling SiriusXM Listener care:

- Visit www.siriusxm.com/activatenow
- Call SiriusXM Listener Care at 1-866-635-2349

For Canadian Subscriptions, please contact:

- Visit www.siriusxm.ca/activatexm
- Call XM customer Care at 1-877-438-9677

Activation typically takes 10-15 minutes, but may take up to one hour. It is recommended to leave your vehicle on until the "Subscription Updated" message appears.

ADVUNI400CP

SiriusXM® User Interface

The on-screen indicators and touch key areas for SiriusXM® functions are outlined below.



SiriusXM® Menu Page 1

SRC Icon - Touch to return to the unit's Main Menu Screen.

Band indicator (SXM1 icon) - Displays SiriusXM® radio band currently selected. Three bands are available: SXM1, SXM2, and SXM3.

Time Display - This indicator displays the time as entered by the user in the Settings Menu.

Signal Strength Indicator γ .ii - As the strength of the satellite radio signal increases, the number of illuminated segments will increase.

Program Information:

Channel Number - Channel numbers are used to designate the channel along with the channel name and are useful for identifying/loading a channel via the "direct entry" method.

Channel Name - The channel name is used to identify the channel and is usually related to that channel's musical content.

Category Name - A category may contain one or more channels grouped by their similar content into a "Category".

Artist Name - This area displays the name of the artist currently playing.

Song - This area displays the name of the song currently playing.

Info - This area contains additional information related to the song/track now playing.

More ▲ Icon - Touch to go to SiriusXM® Menu Page 2.

Direct Entry Icon - Touch to display the Direct Entry Menu.

ADVUNI400CP

Previous (◀◀) Icon - Touch to tune to the previous channel.

Channel/Category Icon - Touch to toggle the icon displayed between Category and Channel. When Channel is displayed, touching ▶▶ or ◀◀ tunes channels up or down. When Category is displayed, touching ▶▶ or ◀◀ tunes channels within a category up or down.

Next (▶▶) Icon - Touch to tune to the next channel.

List Icon - Touch to select a channel search criteria. Presets lists preset channels stored by the user. Channels lists all SXM channels. Category lists SXM channels by categories.

ADVUNI400CP



SiriusXM® Menu Page 2

More ▼ Icon - Touch to go to SiriusXM® Menu Page 1.

Band Icon - Touch to select a band of preset channels. Three bands are available: SXM1, SXM2, and SXM3. Each band can store up to ten preset channels. (Preset channels are accessed from the List icon.)

Mem Icon - Touch to display screen used to enter current channel into preset memory.

Scan Icon - Touch to scan all channels starting at channel 1. The tuner will pause for approximately five seconds at that channel. Touch scan again to listen to that channel. If scan is not touched, the tuner will automatically seek the next channel.

Lock Icon - Touch to display the SXM Lock Screen.

CHG PWD Icon - Touch to go to the change password screen.

EQ Icon - Touch to access the Equalizer level settings menu.

ADVUNI400CP

Switching to SiriusXM® Radio

- Touch the top left corner of the screen (the **SRC** box) to view the Main Menu screen. From the Main menu screen, touch the **SiriusXM** icon.
- Press the **MENU** button on the front panel to switch to the SXM source.

Selecting the SiriusXM® Band

Touch the **Band** icon on the SXM Menu screen to change between the following bands: SXM1, SXM2, and SXM3.

Seek Tuning

- To fast seek the next higher channel, touch and hold the **▶▶** icon.
- To fast seek the next lower channel, touch and hold the **◀◀** icon.

Direct Tuning

To enter a SiriusXM® radio channel directly:

1. On the SiriusXM® menu page 1, touch the **Direct Entry** icon to display the Direct Entry Menu.



SXM Direct Entry Screen

2. Enter the desired SiriusXM® radio channel using the on-screen number pad then touch the **OK** icon. If you wish to delete an entry number touch the **X** icon.
3. To exit the screen without changing the channel, touch the **Back** icon.

ADVUNI400CP

Using Preset Channels

A preset is a channel name that is stored for instant access to that channel. Ten numbered preset buttons store and recall channels for each band.

Storing a Channel

1. Select a band (if needed), then select a channel.
2. On the SiriusXM® menu page 2, touch the **Mem** icon to access the Preset Channel Screen.



SXM Preset Channel Screen

3. Touch the preset number (P1 through P10) in which you would like to store the current channel (or touch the **Back** icon to cancel and close the menu). The channel will be stored and displayed in that preset. Touch the ▲ or ▼ icon to scroll up or down the list.
4. Touch the **Back** icon to return to the SXM Menu screen.

Recalling a Channel

1. Touch the List icon.
2. Touch the Preset icon to access the Recall Preset Channel Screen.



Recall Preset Channel Screen

3. Touch a channel on the preset channel list to select the corresponding stored channel. Touch the ▲ or ▼ icon to scroll up or down the list.

ADVUNI400CP

Searching for a Channel

Search by Channel

To search by channel:

1. On the SiriusXM® menu page 1, touch the **Category/Channel** icon (if needed) to select **Channel**.
2. Touch **List** to display the Channel Search Screen:



Channel Search Screen

3. Touch a channel to tune to that channel. Touch the ▲ or ▼ icon to scroll up or down the list.

Search by Category

Categories group music by type such as jazz, rock, classical, etc. To search by category:

1. On the SiriusXM® menu page 1, touch the **Category/Channel** icon (if needed) to select **Category**.
2. Touch **List** to display the Category Search Screen:

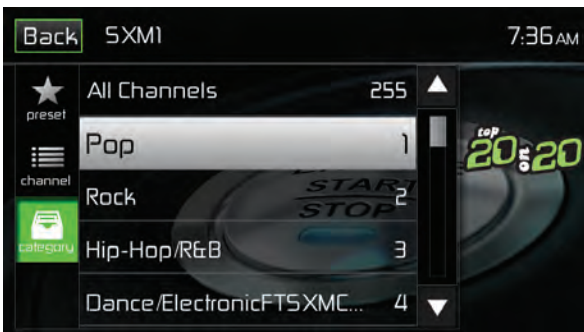

Category Search Screen

3. Touch a category item. A channel list screen appears.
4. Touch a channel to tune to that channel. Touch the ▲ or ▼ icon to scroll up or down the list.

ADVUNI400CP

Locking SXM Mature Channels

SiriusXM® attaches a label to channels with mature content. The radio recognizes these channels as “Mature”. The Mature Channel Lock option allows you to lock out channels with “Mature” labels. These channels will still appear in the channel listing (with a lock  icon), but will not be tunable unless the parental lockout password is correctly entered.

Lock Mature Channels

To lock mature channels:

1. On the SiriusXM® menu page 2, touch the **Lock** icon. The following screen appears:



Enter Lock Password Screen

2. Enter your 4-digit password and then press the **OK** icon. The following screen appears:



Lock Screen

3. Touch the **Lock Mature** icon. The mature channels are now locked.

ADVUNI400CP

Temporarily Unlock a Mature Channel

When the global “Mature Lock” is enabled, a mature channel can be temporarily unlocked. All mature channels are temporarily unlocked (but still hidden when channel browsing) until the SXM source is changed, Accy (Key) is cycled or the “Power Button” on front panel of radio turns the Radio off.

This mode is useful for listening to mature/adult content on a temporary basis, allowing you to listen on a locked channel without having to disable the global “Mature Lock.”

To temporarily unlock a mature channel:

1. Tune to a mature channel. If the channel is locked, **Ch Locked, Code?** will appear on the SiriusXM® User Interface tuner screen.



Channel Locked Screen

2. Enter the 4-digit password and then press the **OK** icon to unlock the channel to tune it.

ADVUNI400CP

Unlock All Mature Channels

To unlock all mature channels:

On the SiriusXM® menu page 2, touch the **Lock** icon. The following screen appears:



Enter Lock Password Screen

3. Enter your 4-digit password and then press the **Ok** icon. The following screen appears:



4. Touch the **Unlock All** icon. All channels are now unlocked.

ADVUNI400CP

Locking Individual SXM Channels

An user can lock individual channels. When locked, a channel has the lock (🔒) icon next to it on the channel list.

Locking a Channel

To lock an individual channel:

1. On the SiriusXM® menu page 2, touch the Lock icon. The following screen appears:



Enter Lock Password Screen

2. Enter your 4-digit password and then press the **OK** icon. The following screen appears:



Lock Screen

3. Touch an unlocked (🔓) icon. The icon is replaced by a lock (🔒) icon. The channel is now locked.

ADVUNI400CP

Unlocking a Channel

To unlock an individual channel:

1. On the SiriusXM® menu page 2, touch the Lock icon. The Enter Password Screen appears.
2. Enter your 4-digit password. The following screen appears:



Unlock Screen

3. Touch a lock (🔒) icon to unlock a channel. The icon is replaced by an unlocked (🔓) icon. The channel is now locked.

Change Lock Password

The Change Lock Password option allows you to change the password from the default or current custom password to another password.

NOTE: The default password is 0, 0, 0, 0.

To change a password:

1. Touch the **CHGPWD** icon. The following screen appears:



Change Password Screen

2. Enter your 4-digit password and press the **OK** icon.
3. Enter the new 4-digit password and press the OK icon. The new password is set.

ADVUNI400CP

SiriusXM® Radio Advisory Messages

SiriusXM® user advisory messages are listed below:

Advisory Displayed	Cause
Check SXM Tuner	Check the SiriusXM® tuner connection on the back of the unit to ensure that it's correctly connected.
Check SXM Antenna	Ensure the SiriusXM® antenna cable is connected to the SiriusXM® tuner correctly. Check the SiriusXM® antenna wire for breaks or sharp bends. Replace the antenna if necessary. If the message remains, the antenna may have been damaged.
No SXM Signal	The vehicle must be outside, and the antenna must have a clear view of the southern sky. The magnetic antenna must be mounted on the outside of the vehicle for the best reception.
Channel Not Subscribed	This channel is not included in your SiriusXM® subscription plan. Call 1-866-635-2349 to subscribe.
Channel Not Available	This channel is not a valid SiriusXM® channel. The channel number has been entered incorrectly, or the channel was removed from the SiriusXM® channel lineup.
Channel Locked	The selected channel has been locked by the parental controls, or a mature channel has been selected. A prompt to enter the unlock code will appear. Enter the unlock code.

ADVUNI400CP

APPLE CARPLAY™ OPERATION

Apple CarPlay™ is a smart interface for iPhone, allowing you to voice-control (via Siri) music, navigation, phone and messaging apps - significantly reducing driver distraction.



Phone - Use Siri to make calls, return missed calls, listen to voicemail messages, and view the caller ID on the receiver's screen.



Messages - Ask Siri to send, read, and reply to text messages. This hands free operation minimizes distraction and allows you to keep hands on the wheel and eyes on the road.



Music - Access music by artist, song, playlist, and more through the receiver's touchscreen or via Siri. The receiver will mirror the iPhone screen with artist and track information.



Maps - Use Siri to request turn-by-turn directions – search by address or points of interest. Apple Maps will be mirrored on the screen, including traffic information and estimated time to destination.

Compatible Devices

Made for iPhone models:

iPhone 7, iPhone 6 Plus, iPhone 6, iPhone 5s, iPhone 5c and iPhone 5

Made for iPod models:

iPod touch (5th / 6th generation) and iPod nano (7th / 8th generation)

NOTE:

“Made for iPod” and “Made for iPhone” mean that an electronic accessory has been designed to connect specifically to iPod, or iPhone, respectively, and has been certified by the developer to meet Apple performance standards. Apple is not responsible for the operation of this device or its compliance with safety and regulatory standards. Please note that the use of this accessory with iPod, or iPhone may affect wireless performance.

Starting Apple CarPlay™

Connect an iPhone to the receiver's USB port using a Apple Certified Lightning cable (not included). Apple CarPlay will launch automatically. The familiar applications will appear on the receiver's touchscreen to activate Siri voice control.

ADVUNI400CP

Using Apple CarPlay™

When the CarPlay menu is displayed, the home button in the lower left corner work just like the home button on your iPhone.

- Ⓞ Press and hold it to summon Siri and begin your voice commands.
- Ⓞ At any time during CarPlay operation, you can press this button momentarily to return to the main CarPlay menu screen.

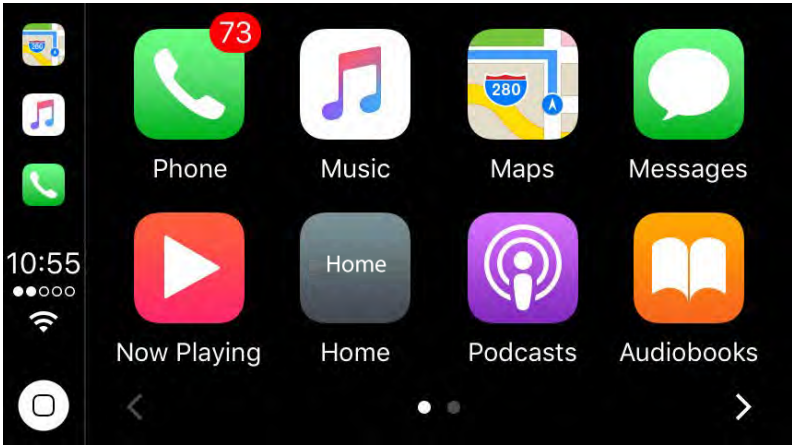

Press any Application button on the main CarPlay menu to access that operation directly.

The toolbar on the left side of the screen displays the time, signal strength and shortcuts to the most popular applications - Phone, Music and Navigation - so they can be accessed quickly and easily without returning to the main menu.

NOTE:

For safety reasons, CarPlay features are limited while driving and will vary with each CarPlay-enabled app. Available functions are determined by each individual app provider. For more information, visit www.apple.com/ios/carplay.

NOTE:

Certain iPhone functions may be illegal while driving in your location. Be sure to familiarize yourself with local and state laws regarding mobile devices. When in doubt, stop and park your vehicle before using any devices.

ADVUNI400CP

Controlling Apple CarPlay™

The following basic controls will operate many standard CarPlay features.



Touch

Briefly press the desired option.



Swipe

Briefly swipe in the desired direction.



Drag

Press, hold and drag to the desired location.

Additional Notes

1. There is no need to pair your iPhone when using CarPlay. This will occur automatically when connecting an iPhone to the unit's USB port.
2. When CarPlay is in use, the unit's Bluetooth will turn off automatically and hands-free functionality will operate through the CarPlay feature. Any other devices connected via Bluetooth will be disconnected during CarPlay use.

Exiting Apple CarPlay™

Disconnecting your iPhone will automatically exit CarPlay mode. To exit CarPlay mode while your phone is still connected, press the Power/Volume knob momentarily, and the unit's main menu will be displayed.

ADVUNI400CP

User Up-Loadable Wallpaper

In addition to the 5 selectable wallpaper selections, you can up load your own wallpaper image to the ADVUNI400CP.

Note: The wallpaper image must have a .bmp file extension and the size / resolution must be 800x480, 24 or 32 bit. Other file sizes / resolutions will result in the image being enlarged or reduced and may appear distorted.

Uploading User Wallpaper

Only one user wallpaper can be loaded at a time into the ADVUNI400CP. However, the user wallpaper can be loaded an infinite amount of times.

1. Take out and set aside the navigation microSD card that came in the ADVUNI400CP. Do not delete or modify the folder structure. Insert a microSD card with wallpaper images into the microSD card slot.
2. Go to Settings > General > Wallpaper > Custom.
3. Select a wallpaper image and press "OK" to load the new wallpaper image.
4. Remove microSD card.

ADVUNI400CP

TROUBLESHOOTING

Troubleshooting

Problem	Cause	Corrective Action
GENERAL		
Unit will not power on	Radio Fuse open	Install new fuse with correct rating
	Car battery fuse open	Install new fuse with correct rating
	Illegal operation	Press the RESET button located in the middle of the left side of the front panel
No/low audio output	Improper audio output connection	Check wiring and correct
	Volume set too low	Increase volume level
	Improper "MUTE" connection	Review wiring diagram and check "MUTE" connection
	Speakers damaged	Replace speakers
	Heavily biased volume balance	Adjust the channel balance to the center position
	Speaker wiring is in contact with metal part of car	Insulate all speaker wiring connections
Poor sound quality or distortion	Pirated disc is in use	Use original copy
	Speaker power rating not compatible with unit	Connect proper speakers
	Speaker is shorted	Check speaker contact
Unit resets itself when engine is off	Incorrect connection between ACC and positive battery wire	Check wiring and correct

ADVUNI400CP

Problem	Cause	Corrective Action
TFT Monitor		
No image	Incorrect connection to parking brake wire	Check wiring and correct
	Parking brake is not engage	Stop vehicle in safe place and apply parking brake
Flashing image or interference appears on screen	DVD is not compatible with current TV system settings	Change setup to accommodate disc
	Improper video signal connections	Check wiring and correct
Prolonged image or improper height/width ratio display	Improper aspect ratio setup	Use correct aspect ratio setting
TUNER		
Weak station searching	Auto antenna is not fully extended	Extend antenna fully or connect the auto antenna control cable properly
	Auto antenna not properly connected	Connect the auto antenna control cable properly
	LOCAL function is activated	Turn LOCAL function off
DISC		
Cannot insert disc	Disc already inside unit	Eject current disc and insert new one
Image blurred, distorted or dark	Disc is illegally copied	Use original disc

ADVUNI400CP

Problem	Cause	Corrective Action
Disc does not play back	Disc is warped or scratched	Use disc in good condition
	Disc is dirty or wet	Clean disc with soft cloth
	Laser pickup is dirty	Clean laser pickup with cleaning disc
	Incompatible disc is used	Use compatible disc
	Disc rating exceeds Parental Lock rating limit	Change Parental Lock settings to lower restriction
	Disc region code is not compatible with unit	Use disc with proper region code
	Disc is inserted upside down	Insert disc with label side up
MP3		
Interruption occurred during playback	Disc is dirty or scratched	Clean disc or replace
	File is damaged/bad recording	Recreate disc with good file

ADVUNI400CP

Disc Error Messages

Message Displayed	Cause	Corrective Action
Loading	Disc is being read	
No Disc	Disc is dirty	Clean disc with soft cloth
	Disc is upside down	Insert disc with label side up
	Disc not present in loading compartment	Insert disc
Bad Disc	Disc is dirty	Clean disc with soft cloth
	Disc is upside down	Insert disc with label side up
Unknown disc	Disc format is not compatible with this unit	
Region Error	DVD is not compatible with region code of unit	
Error	Illegal mechanism operation	Press EJECT button for 5 seconds to reset loading mechanism

CARE AND MAINTENANCE

1. Use only a clean silicone cloth and neutral detergent to clean the front panel or monitor. A rough cloth and non-neutral detergent (such as alcohol) may result in scratching or discoloration.
2. Do not get water or cleaning fluids on the unit.
3. If the temperature inside the player gets too hot, a protective circuit automatically stops play of the disc. If this occurs, allow the unit to cool before operating the player again.
4. Never insert anything other than a 12 cm (5") compact disc into the player as the mechanism can be damaged by foreign objects.
5. Do not attempt to use a 8 cm (3") CD-Single disc in this unit, either with or without an adapter, as damage to the player and/or disc may occur. Such damage is not covered by the Warranty on this product.
6. The CD player may not operate properly in extreme hot or cold. If such conditions occur, allow the interior of the vehicle to reach a normal temperature before using player.
7. When the vehicle warms up during cold weather or under damp conditions, condensation may appear on the LCD panel. Should this occur, the screen will not operate properly until the moisture has evaporated.
8. We suggest you use a cleaning disc in this unit more frequently than in the unit in your home due to the environmental conditions of the vehicle.

ADVUNI400CP

SPECIFICATIONS

DVD/CD Player

Compatible Disc Media: DVD \pm R / RW (Single and Dual Layer) and CD-R / RW
Compatible Media Formats: CD-DA, MP3, WMA, VCD, SVCD, Xvid, AVI, MPEG 1/2 and AAC

Signal to Noise Ratio: >95dBA

Dynamic Range: >95dB

Frequency Response: 20Hz to 20 kHz, -3dB

Channel Separation: > 60dB @ 1 kHz

D/A Converter: High Performance Multi-Bit Sigma-Delta Modulator

Video

Format: NTSC, PAL (auto-detection)

Output: 1Vp-p (75-ohm)

Input: 1Vp-p (75-ohm)

FM Tuner

Tuning Range: 87.5MHz - 107.9MHz

Mono Sensitivity (-30dB): 9dBf

Quieting Sensitivity (-50dB): 15dBf

Alternate Channel Selectivity: 70dB

Signal to Noise Ratio @ 1 kHz: 58dB

Image Rejection: 80dB

Stereo Separation @ 1 kHz: >30dB

Frequency Response: 35Hz - 15 kHz, -3dB

AM Tuner

Tuning Range: 530 kHz - 1720 kHz

Sensitivity (-20dB): 15uV

Signal to Noise Ratio @ 1 kHz: 50dB

Image Rejection: 60dB

Frequency Response: 50Hz - 2.5kHz, -3dB

Monitor

Screen Size: 6.2" (Measured diagonally), 16:9 Widescreen

Screen Type: TFT LCD

Resolution: 800h x 480v x RGB WVGA

ADVUNI400CP

General

Auxiliary (Audio) Input Impedance: 10kOhm

Power Supply: 14.4VDC Nominally, Negative Ground Only (11VDC to 16VDC Allowable)

Power Antenna / Amp Remote (Blue): 500mA max (Current Limited Protection)

Operating Temperature: 0C ~ 65C / 32F ~ 149F

Fuse: 15-Amp, ATO type

Chassis Dimensions: 7" X 7" X 4" (178mm x 178mm x 100mm)

CEA Power Ratings



Power Output: 13 Watts RMS x 4 channels into 4 Ohms @ < 1% THD+N

Signal to Noise Ratio: 70dBA below reference (Reference: 1 Watt, 4-Ohms)

Frequency Response: 20 Hz - 20 kHz, -3dB. (Aux Input used as reference input)

Reference Voltage: 14.4VDC

*Specifications are subject to change without notice.

ADVUNI400CP

NOTES:

ADVUNI400CP

www.AdventProducts.com
© 2018 VOXX Electronics Corp.
Printed in China

ADVUNI400CP Common Replacement Parts

Wire Harness (Pwr/Spk/Line Out/Mic/GPS Antenna)	
Trim Ring	
Remote Control	
Hardware Bag	

Operation manuals and other material online at: www.AdventProducts.com

