

Gentex by VOXX Corporation

Installation Instructions

Bezelled w/ Homelink

ADVGEN45A4PW4
ADVGEN40A4
ADVGEN45AB5
ADVGEN45A4

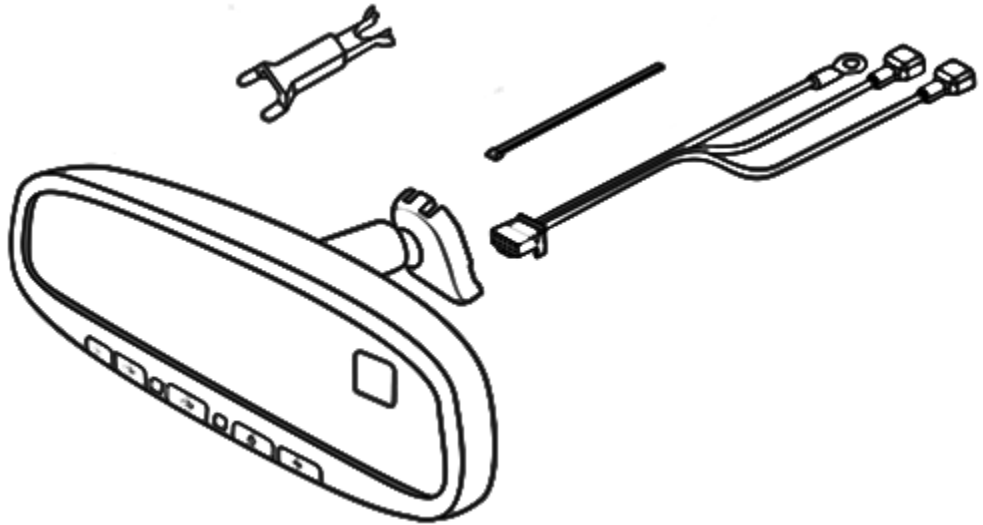

Frameless

ADVGEN8EXP

Frameless w/ Homelink

ADVGENFL85EXP
ADVGENFL80EXP

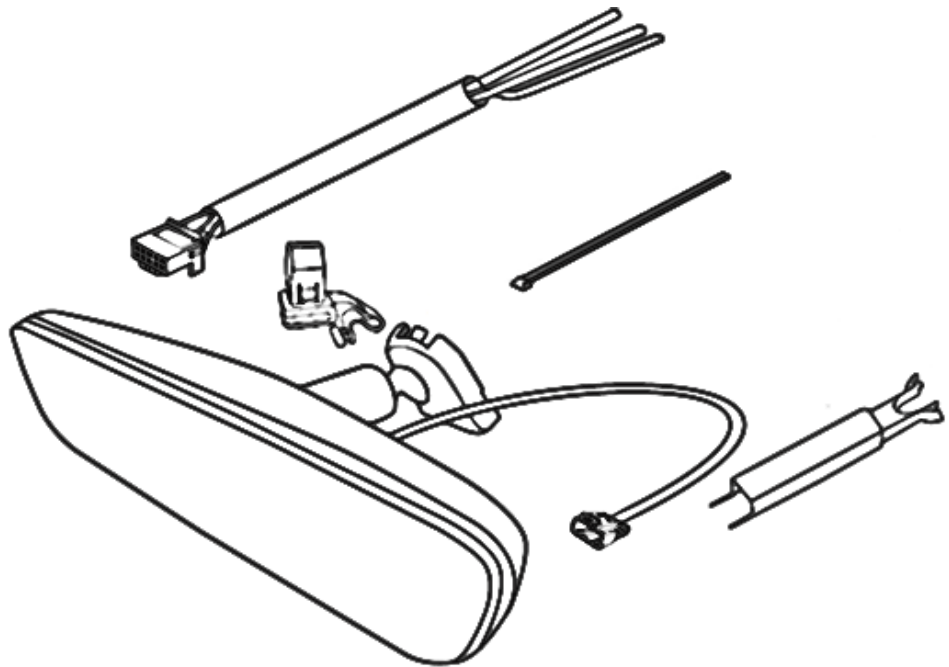

TOOLS REQUIRED:

Safety Glasses
Clean Rag
DC Voltmeter

Utility Knife
Electrical Tape
Fish-Wire (Coat Hanger)

Pliers
4mm Flat Screwdriver
#T20 Torx Driver

#2 Phillip's Screwdriver
Flashlight
Panel Removal Tool

INSTALLATION PRECAUTIONS / NOTES:

- **Do not** use excessive force when removing OEM mirror from windshield.
- **Do not** push fish-wire too far into dash to avoid damage to existing components.
- **Do not** place wire harness against objects with sharp edges that may cause electrical shorting.
- On vehicles equipped with A-pillar (side impact or SRS) airbags, verify mirror harness path remains clear of airbag. Harness should follow and be secured to, existing OEM wiring with tie wraps.
- Verify that auto-dimming mirror harnesses do not interfere with brake, clutch, emergency brake or air bag

1 Preparation

Perform the following pre-installation steps:

1. Place kit components on a clean, padded surface.
2. Record your programmed radio stations.
3. Remove driver side scuff plate. (Fig. 1)

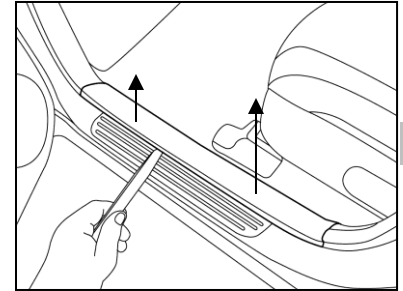

1

4. Remove driver side door seal. (Fig. 2)

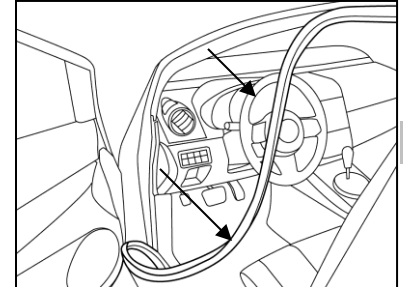

2

5. Remove driver side kick plate / cowl cover. (Fig. 3)

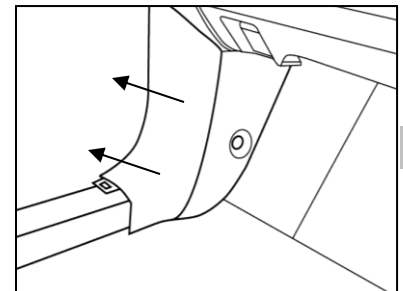

3

6. Remove driver side grab handle if equipped. (Fig. 4)

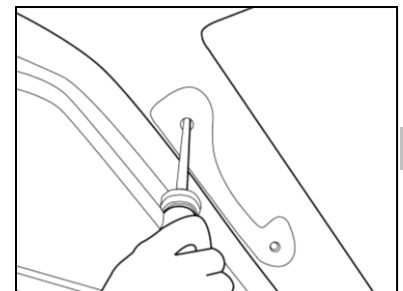

4

7. Remove driver side A-pillar trim. (Fig. 5)

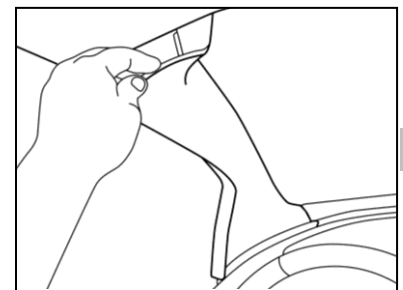

5

CAUTION 8. Remove OEM mirror. (Fig. 6,7 or 8)

! Do not use excessive force. Damage to windshield could occur.

- a) Loosen #T20 torx screw on mirror mount and slide mirror upwards off from windshield button. (Fig. 6)

-- OR --

- b) Insert 4mm into opening at bottom of mirror mount to disengage locking tab and slide mirror upwards off from windshield button. (Fig. 7)

NOTE: Gently wiggling mirror while sliding upwards will assist removal.

-- OR --

- c) Insert panel removal tool into opening at bottom of mirror mount to disengage locking tab and slide mirror upwards off from windshield button. (Fig. 8)

NOTE: Gently wiggling mirror while sliding upwards will assist removal.

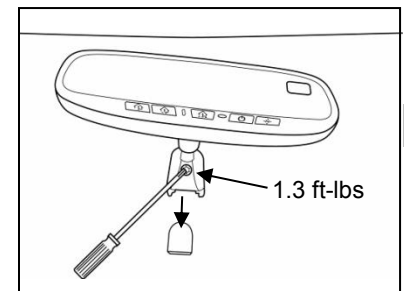
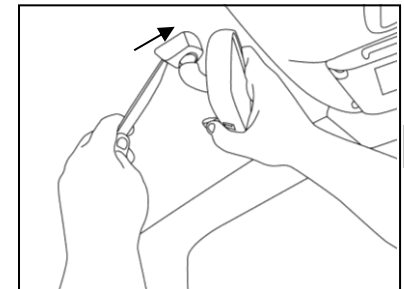
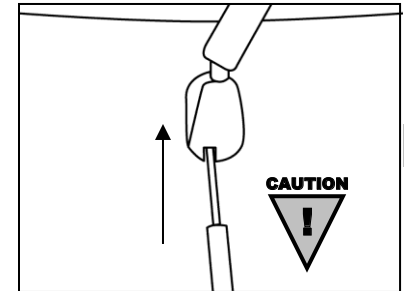
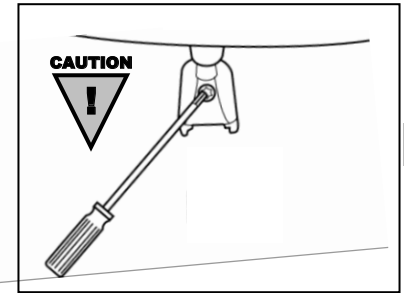

2 Auto-Dimming Mirror Installation

1. Attach auto-dimming mirror.

- a) Hold the mirror and slide the mirror downwards over windshield button until fully seated. (Fig. 9)
- b) Using #T20 torx driver, tighten the mirror mounting bracket screw to 1.3 ft-lbs (17.8 kg-cm). **DO NOT OVERTIGHTEN**

3 Route Auto-Dimming Mirror Harness to Vehicle Power

NOTE: You will need to find a supply wire in your vehicle that provides +12V when vehicle is running or the key is in the ON or ACC position. You will also need to find a supply wire that provides +12V constant power when vehicle is both ON and OFF. Your automotive repair shop may sometimes be able to advise readily available locations for connecting to these power sources.

A TIP: The cigarette lighter or power port receptacle may be a source of switched +12V or constant +12V, depending on vehicle make.

1. Locate ignition (+12V switched) wire.

- a) Using a multi-meter, find a wire exiting the fuse block or junction block that tests +12V and is controlled by the ignition switch. Operate vehicle accessories (power windows, door locks, power mirrors, etc.) to ensure that voltage does not drop on this wire. (Fig. 10)
- b) Ensure power in this wire is off when vehicle key is OFF and label wire "IGNITION."

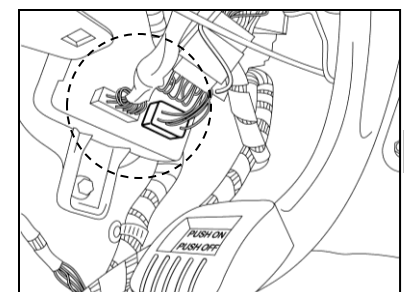

2. Locate constant power (+12V constant) wire.

- a) Using a multi-meter, find a wire exiting the fuse block that tests +12V with vehicle ignition in the ACC, ON and OFF positions. **(Fig. 11)**
- b) Ensure power in this wire is still present when vehicle key is OFF and label wire "CONSTANT."

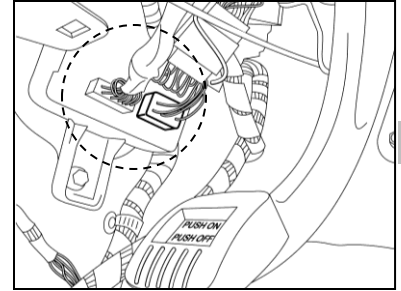

11

3. Disconnect vehicle's negative battery terminal. (Fig. 12)

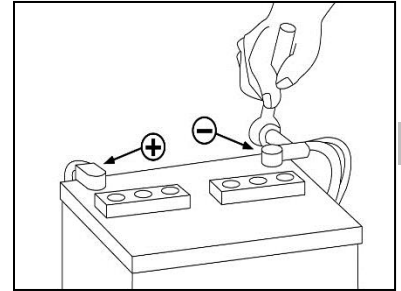

12

4. Plug auto-dimming mirror harness into back of mirror. (Fig. 13)

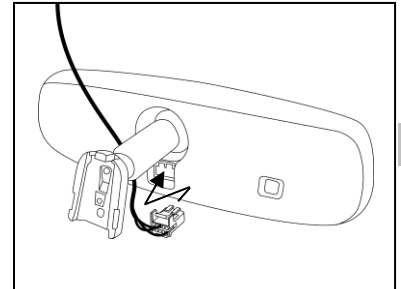

13

5. Route harness up to vehicle headliner. (Fig. 14)

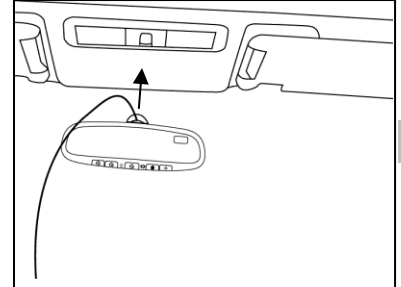

14

- a) Install optional wire cover (if purchased). **(Fig. 15)**

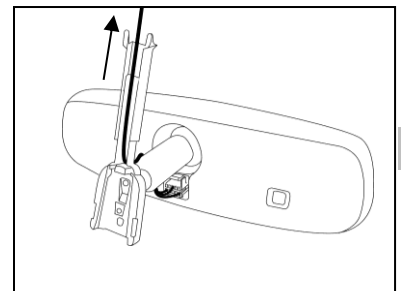

15

6. Route haress across vehicle headliner to top of A-pillar on side of vehicle where vehicle connection wires / fuse block were found.

- a) Use panel removal tool to ensure harness is tucked between headliner and roof of vehicle. **(Fig. 16)**

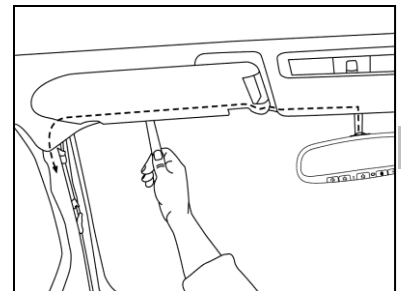

16

7. Route harness down A-pillar. (Fig. 17)

NOTE: Harness will be secured later in installation procedure.

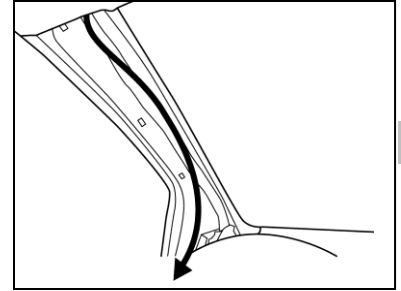

17

8. Route harness to vehicle connection wires.

- a) Using fish-wire, route harness from base of A-pillar through dash and into connection wire / fuse block area. (Fig. 18)

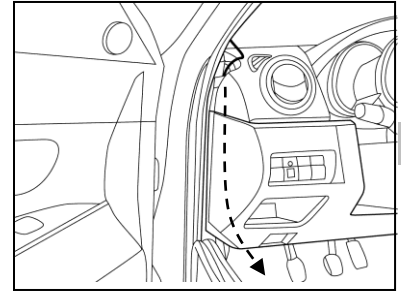

18

9. Attach wire tap to vehicle wire marked IGNITION.

- a) Center blade of wire tap on IGNITION wire and close wire tap with pliers. (Fig. 19)
- b) Ensure both halves of wire tap are closed completely and locking tab is engaged.

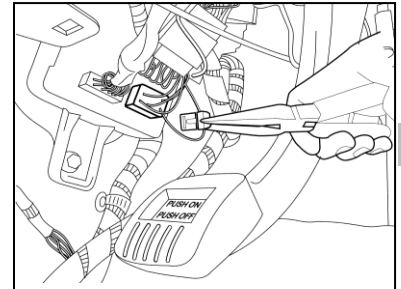

19

10. Connect auto-dimming mirror harness switched power wire to vehicle wire marked IGNITION.

- a) Locate the harness wire with **WHITE STRIPE**.
- b) Insert spade terminal on **WHITE STRIPE** wire into the wire tap on the vehicle wire labeled **IGNITION**. (Fig. 20)

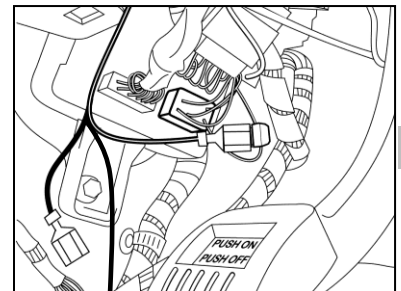

20

11. Attach wire tap to vehicle wire marked CONSTANT.

- a) Center blade of wire tap on **CONSTANT** wire and close wire tap with pliers. (Fig. 21)
- b) Ensure both halves of wire tap are closed completely and locking tab is engaged.

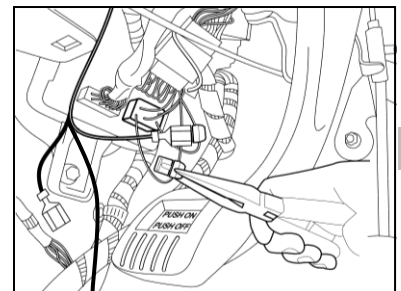

21

12. Connect auto-dimming mirror harness constant power wire to vehicle wire marked CONSTANT.

- a) Locate the **SOLID BLACK** harness wire with spade terminal.
- b) Insert spade terminal on **SOLID BLACK** wire into the wire tap on the vehicle wire labeled **CONSTANT**. (Fig. 22)

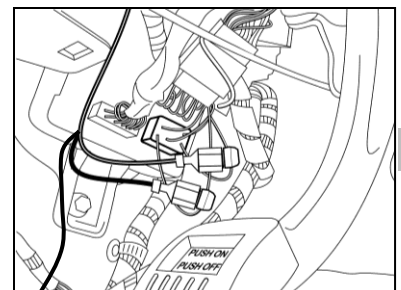

22

13. Connect auto-dimming mirror harness ground wire.

- a) Locate a ground bolt near connection / fuse block area and remove.
NOTE: Bolt locations may vary but common locations are in the kick plate / cowl cover area or parking brake release handle.
- b) Install ring terminal of harness over bolt and reinstall. (Fig. 23)



23

5 Testing.

1. Reconnect negative battery cable.
2. Turn the ignition switch ON/ACC position.
3. With the vehicle in a fairly well-lit area, perform the following:

- a) To make sure the auto-dimming feature is on, verify that the green LED to the left of the center switch is on. If it is not on, push the  switch to turn the green LED on.
- b) Cover the forward looking photocell on the back of mirror with a dark cloth or towel. (Fig. 24)

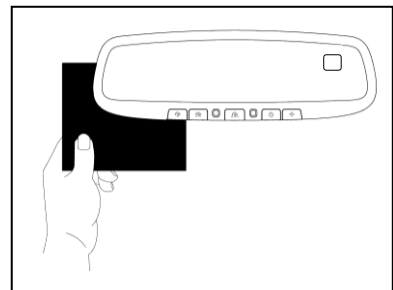

24

In a few seconds, the mirror will begin to darken.

NOTE: Time to darken will vary with ambient light level.

- c) Remove the cover from the forward looking photo cell and the mirror will begin to clear.
- d) Verify that either a direction, such as NE, or "CAL" is displayed in the display window. If not, ensure the feature is turned ON by pressing the  button.

4. Turn the ignition key to the OFF position.
5. Push each HomeLink[®] button (if equipped), one at a time, and verify that LED indicator to the left of the center switch illuminates with a red LED. (Fig. 25)

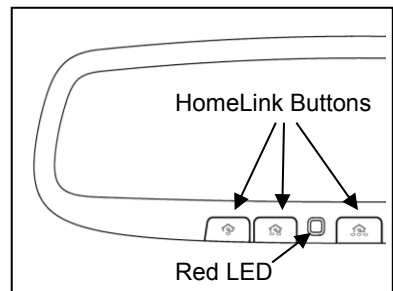

25

6. If mirror is equipped with maplights, push each maplight button to ensure lights are operational. (Fig. 26)

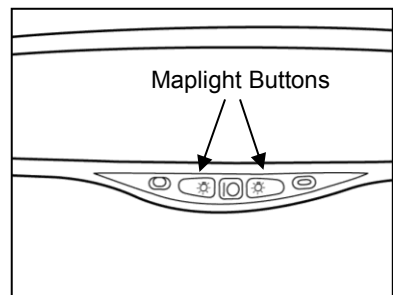



26

7. Testing is now complete.

1. Adjust compass zone after EC mirror installation.

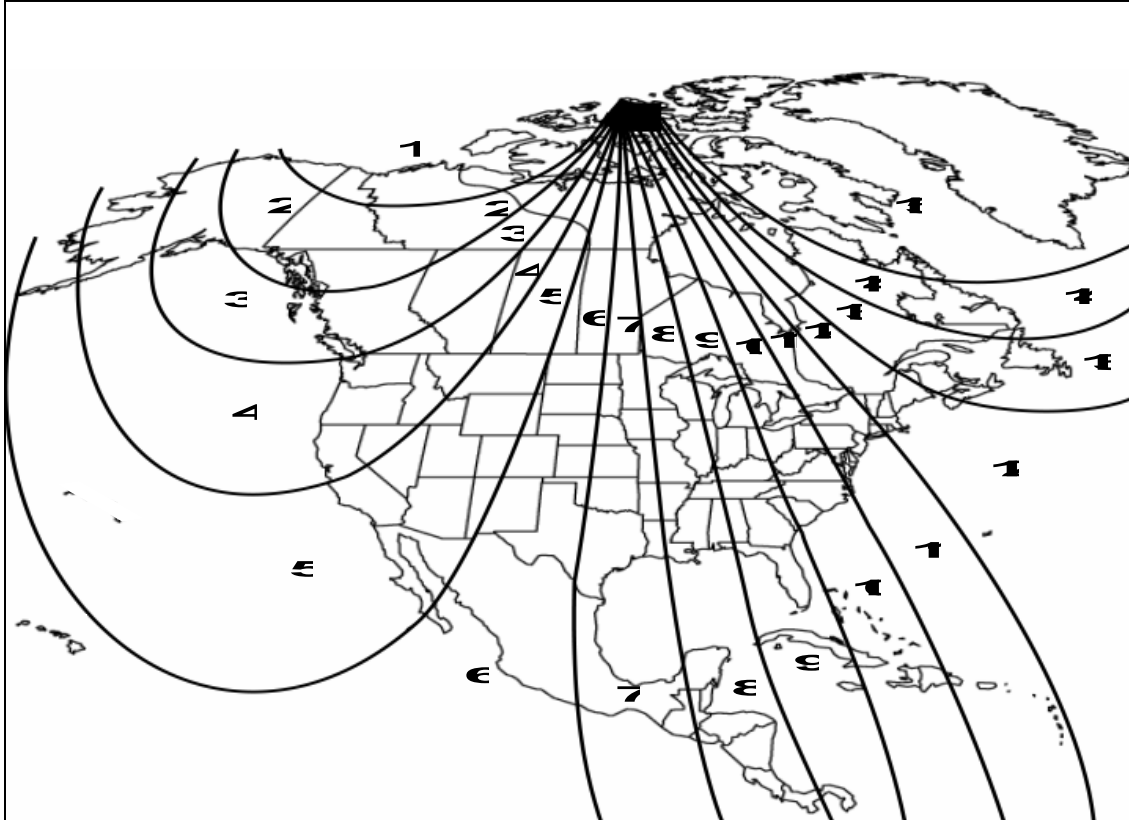

- a) The zone setting is factory preset to Zone 8. Refer to Compass Calibration Zone Map to find correct compass zone setting for your geographical location. (Fig. 27)



- b) To change the zone setting, push and hold the  button until a number appears in the display. Press button repeatedly until desired compass zone number is reached.

Compass Calibration

1. Calibrate compass.

- a) Drive to an open, level area, away from large metallic objects or structures.
- b) Hold the  button for approximately 9 seconds until "CAL" or "C" text appears in the display. Release the  button to enter the calibration mode.
- c) Drive slowly in up to 3 circles until the "CAL" or "C" text disappears, and a directional heading is displayed.

The compass is now calibrated.

To Operate the HomeLink® Feature:

Please refer to the programming instructions outlined in this manual or:

- a) Visit the HomeLink® website at www.homelink.com
- b) Call the HomeLink® customer support line at 1-800-355-3515

WARNING! Before programming HomeLink® to a garage door opener or gate operator, make sure that people and objects are out of the way of the device to prevent potential harm or damage. When programming a garage door opener, it is advised to park outside of the garage. Do not use HomeLink® with any garage door opener that lacks safety stop and reverse features as required by U.S. federal safety standards (this includes any garage door opener model manufactured before April 1, 1982). A garage door that cannot detect an object – signaling the door to stop and reverse – does not meet current U.S. federal safety standards. For more information, contact HomeLink® at www.homelink.com or by calling 1-800-355-3515.

1. To begin, press and hold the 2 outer HomeLink® buttons (to clear memory) until the indicator light (LED) blinks slowly (approximately 20 seconds). **(Fig. 28)**

2. Release both buttons.

NOTE: Do not hold the buttons for longer than 30 seconds. Do not repeat this step when programming additional devices to remaining buttons.

3. Position the end of the hand-held transmitter 1-3 inches away from the HomeLink® button you wish to program while keeping the indicator light in view.
4. Simultaneously press and hold both the chosen HomeLink® and hand-held transmitter buttons. **(Fig. 29)**

Do not release the buttons until step 5 has been completed.

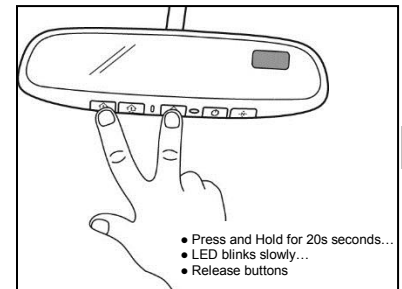

28

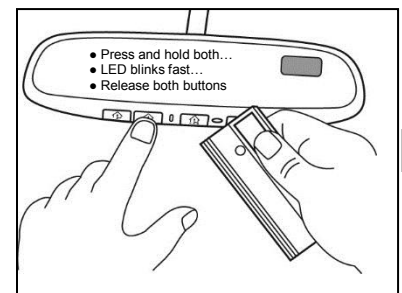

29

NOTE: Some gate operator and garage door openers may require you to replace this Programming step 4 with procedures noted in the “Gate Operator / Canadian Programming” section.

5. After the HomeLink® indicator light changes from a slow to a rapidly blinking light, release both the HomeLink® and hand-held transmitter buttons.
6. Press and hold the just-trained HomeLink® button and observe the indicator light.

If the indicator light blinks rapidly for 2 seconds and then turns to a constant light, the device being programmed utilizes rolling code and programming is not complete until the following steps are completed. **(Fig. 30)**

7. On the garage door opener receiver (motor-head unit) locate the “learn” or “smart” button. This can usually be found where the hanging antenna wire is attached to the motor-head unit.
8. Firmly press and release the “learn” or “smart” button. **(Fig. 31)**

NOTE: You have 30 seconds to initiate step 9.

9. Return to the vehicle and firmly press, hold for 2 seconds and release the programmed HomeLink® button. **(Fig. 32)**
10. Repeat the “press/hold/release” above a second time and possibly a third time (depending on brand of device).

HomeLink® should now activate your rolling code equipped device.

Gate Operator / Canadian Programming:

Canadian radio-frequency laws require transmitter signals to “time-out” or quit after several seconds of transmission – which may not be long enough for HomeLink® to pick up the signal during programming. Similar to this Canadian law, some U.S. gate operators are designed to “time-out” in the same manner.

If you live in Canada or you are having difficulties programming a gate operator by using the “Programming” procedures (regardless of where you live), replace “Programming HomeLink®” step 4 with the following:

NOTE: If programming a garage door opener or gate operator, it is advised to unplug the device during the “cycling” process to prevent possible overheating.

4. Continue to press and hold the HomeLink button while you press and release - every 2 seconds (“cycle”) your hand-held transmitter until the frequency signal has successfully been accepted by HomeLink. (The indicator light will flash slowly and then rapidly.)

Proceed with “Programming” step 5 to complete.

Erasing All Programmed HomeLink Buttons:

Press and hold the two outer HomeLink buttons (as shown in Fig. 1), releasing only when the HomeLink indicator light begins to flash after 20 seconds. Do not hold for longer than 30 seconds.

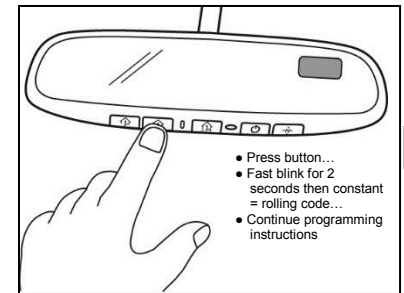

30

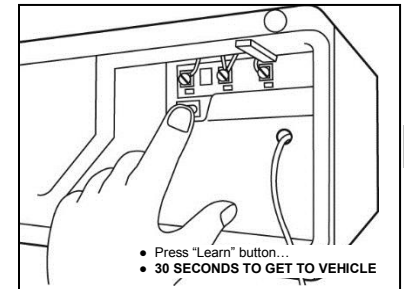

31

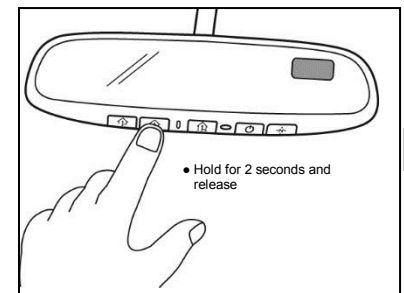

32

For all other questions, please contact VOXX Corporation at

1-800-371-7725

TROUBLESHOOTING

	PROBLEM	SOLUTION
1	"C" or "CAL" is displayed in display window	Perform calibration sequence (ref. Sec. 8)
2	Inaccurate compass direction	Perform compass zone setting procedure (ref. Sec. 7)
		Vehicle magnetics may have changed. Perform calibration sequence (ref. Sec. 8) NOTE: Installing items such as a ski rack, antenna, luggage rack or recent body repair can cause changes to the vehicle's magnetic field.
3	Mirror does not dim	Ensure connector is plugged into back of mirror.
		Ensure harness wires are connected to vehicle wires.
		Ensure nothing is blocking sensor on front of mirror or its viewing path to the rear window of vehicle.
4	Mirror dims constantly	Ensure nothing is blocking forward-looking sensor on back of mirror.
5	Cannot program garage door opener or other remote control device	Contact HomeLink® at 1-800-355-3515 or visit www.homelink.com for more information.
6	Display window shows "SC" (short circuit)	Indicates Short Circuit. Check all power wires to mirror for breaks, crimps or slices. Repair wires with electrical tape.

For customer or technical support please call VOXX support:

1-800-300-4550

9am – 9pm (Eastern) Mon – Friday

10am – 2pm (Eastern) Sat