

JENSEN®

VX3020

6.2" Double DIN Multimedia Receiver

DVD/Built-in Bluetooth/Compatible with iPhone/
Compatible with iPod/USB/Aux In

INSTALLATION GUIDE



What's in the Box

The following items are supplied with the VX3020:

- VX3020 Head Unit
- Trim Ring
- Hardware Bag
- Power/Speaker Output Harness
- Remote Control
- External Microphone
- Owners Manual & Warranty Card
- Installation Guide

Tools and Supplies

The following tools and supplies are needed to install the VX3020:

- Torx type, flat-head and Philips screwdrivers
- Wire cutters and strippers
- Tools to remove existing radio (screw driver, socket wrench set or other tools)
- Electrical tape
- Crimping tool
- Volt meter/test light
- Crimp connections
- 18 gauge wire for power connections
- 16 – 18 gauge speaker wire

WARNING! Never install this unit where operation and viewing could interfere with safe driving conditions.



Optional Equipment

- Steering Wheel Control (SWC)- The VX3020 is SWC ready for vehicles equipped with the option. See wiring diagram for installation details. For SWC programming details, please see the operation manual.
- Rear Camera- The VX3020 is Rear Camera ready for vehicles equipped with the option. See wiring diagram for installation details.

Disconnect the Battery

- To prevent a short circuit, be sure to turn off the ignition and remove the negative (-) battery cable prior to installation.

NOTE: If the VX3020 is to be installed in a car equipped with an on-board drive or navigation computer, do not disconnect the battery cable. If the cable is disconnected, the computer memory may be lost. Under these conditions, use extra caution during installation to avoid causing a short circuit.

Replacing the Fuse

- When replacing the vehicles Radio fuse always use the proper rated replacement fuse. Using a fuse with an improper rating could damage the unit and cause a fire.

ISO-DIN Installation

The VX3020 is designed to fit into a 2.0 DIN dashboard opening. The unit has threaded holes in the chassis side panels which may be used with the original factory mounting brackets of some Toyota, Nissan, Mitsubishi, Isuzu, Hyundai and Honda vehicles to mount the radio to the dashboard. Please consult with your local car stereo specialty shop for assistance on this type of installation.

1. Remove the existing factory radio from the dashboard or center console mounting. Save all hardware and brackets as they will be used to mount the new radio.
2. Remove the factory mounting brackets and hardware from the existing radio and attach them to the new radio.
CAUTION! Do not exceed M5 X 6MM screw size. Longer screws may damage components inside the chassis.
3. Place the radio in front of the dashboard opening so the wiring can be brought through the mounting sleeve. Follow the wiring diagram carefully and make certain all connections are secure and insulated with wire nuts or electrical tape. After completing the wiring connections, plug the ISO connectors into the mating sockets on the rear of the chassis. Turn the unit on to confirm operation (vehicle ignition switch must be "ON"). If the unit does not operate, re-check all wiring until the problem is corrected.
4. Mount the new radio assembly to the dashboard or center console using the reverse procedure in step 1 above.
CAUTION! Be careful not to damage the car wiring.

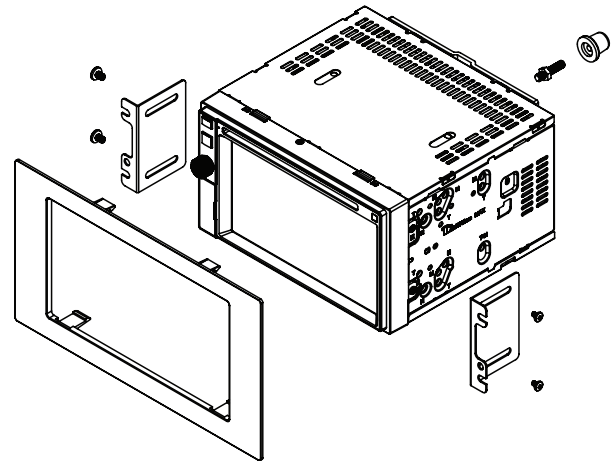

NOTE: It is the end-users responsibility to install and operate this unit in a manner in accordance with local, state and federal laws. The PARKING BRAKE wire MUST BE CONNECTED as directed in the manual.

Using the Cosmetic Trim Ring

A cosmetic trim ring is supplied with the head unit for installation flexibility. This unit will fit into most import dashes with little or no modification to the dash board/cavity. Some US domestic vehicle dashes will accept a Double-DIN chassis, but there is usually a small gap between the radio and dash piece after installation is complete. In this case, use the trim ring to conceal any gaps that may be present.

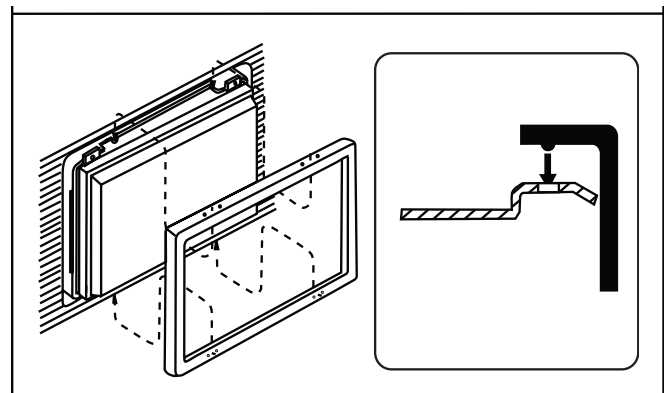

NOTE: For proper operation of the CD/DVD player, the chassis must be mounted within 30° of horizontal. Make sure the unit is mounted within this limitation.

Wiring Diagram

CAUTION! IMPORTANT: Incorrect wiring connections can damage the unit. Follow the wiring instructions carefully, or have the installation handled by an experienced technician.

Need Help? For technical assistance, call the Jensen customer support line at 1-800-323-4815.

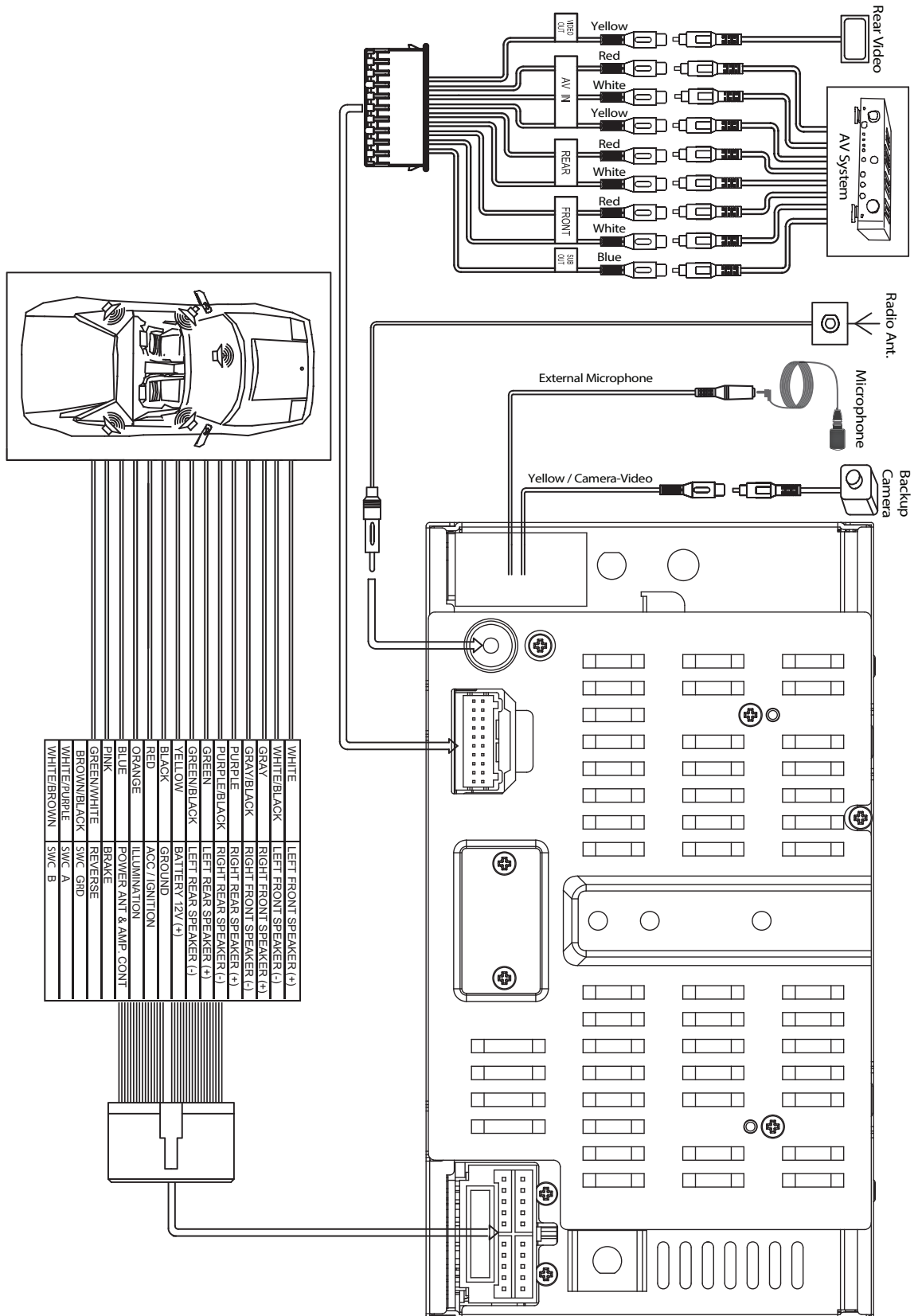

The VX3020 has a built-in SWC interface compatible with most resistive type OE steering wheel controls. In most installations, only two of the three wires will be needed to interface the OE steering wheel controls to the VX3020.

- SWC A - Primary SWC Wire
- SWC B - Secondary SWC Wire
- SWC Ground - Chassis ground

Initial wiring of the SWC interface should include the SWC A and SWC Ground wire. If this combination of wiring does not support your vehicle functions, then try the SWC B and SWC Ground wire combination. Do not use only SWC A and SWC B. The SWC Ground must be connected.

Some vehicles may not support all SWC functions. Professional installation is recommended.



NOTES:





JENSEN[®]



Voxx Electronics Corporation
Hauppauge, NY 11788
Technical Assistance: 1-800-323-4815
www.jensenmobile.com
© 2013
Printed in China