

JENSEN®

VX3010

7" Single DIN Multimedia Receiver

DVD/Built-in Bluetooth/Compatible with iPhone/
Compatible with iPod/USB/Aux In

Operating Instructions



160 watts peak
40W x 4



JENSEN®

VX3010



Thank you for choosing a Jensen product. We hope you will find the instructions in this owner's manual clear and easy to follow. If you take a few minutes to look through it, you'll learn how to use all the features of your new Jensen VX3010 Mobile Multimedia Receiver for maximum enjoyment.

iPod® Control "iPod" is a trademark of Apple Computer, Inc., registered in the U.S. and other countries.

Bluetooth® is a trade mark of Bluetooth Special Interest Group (SIG) Inc.

CONTENTS

FCC STATEMENT	4
SAFETY PRECAUTIONS	5
FEATURES	6
FRONT PANEL CONTROLS AND INDICATORS	8
REMOTE CONTROL OPERATION	10
REMOTE CONTROL BATTERY REPLACEMENT	14
QUICK START	15
SYSTEM SETTINGS	18
RADIO TUNER OPERATION	22
PLAYBACK OF AUDIO FILES	24
EQUALIZER CONTROLS MENU	30
iPod®/iPhone® CONTROLS	32
BLUETOOTH OPERATION	34
AV-In1/AV-In2 CONTROLS	39
STEERING WHEEL CONTROL (SWC) OPERATION	40
REAR CAMERA OPERATION	41
TROUBLESHOOTING	42
SPECIFICATIONS	44
CARE AND MAINTENANCE	46
NOTES	47
VX3010 COMMON REPLACEMENT PARTS	(Back Cover)

FCC Statement

1. This device complies with Part 15 of the FCC Rules.

Operation is subject to the following two conditions:

(1) This device may not cause harmful interference.

(2) This device must accept any interference received, including interference that may cause undesired operation.

2. Changes or modifications not expressly approved by the party responsible for compliance could void the user's authority to operate the equipment.

NOTE: This equipment has been tested and found to comply with the limits for a Class B digital device, pursuant to Part 15 of the FCC Rules. These limits are designed to provide reasonable protection against harmful interference in a residential installation.

This equipment generates uses and can radiate radio frequency energy and, if not installed and used in accordance with the instructions, may cause harmful interference to radio communications. However, there is no guarantee that interference will not occur in a particular installation. If this equipment does cause harmful interference to radio or television reception, which can be determined by turning the equipment off and on, the user is encouraged to try to correct the interference by one or more of the following measures:

- Reorient or relocate the receiving antenna.
- Increase the separation between the equipment and receiver.
- Connect the equipment into an outlet on a circuit different from that to which the receiver is connected.
- Consult the dealer or an experienced radio/TV technician for help.

FCC Radiation Exposure Statement

This equipment complies with FCC radiation exposure limits set forth for an uncontrolled environment. This equipment should be installed and operated with minimum distance of 20 centimeters between the radiator and your body.

This unit supports most iPod/iPhone models.



"Made for iPod," and "Made for iPhone" mean that an electronic accessory has been designed to connect specifically to iPod, or iPhone, respectively, and has been certified by the developer to meet Apple performance standards.

Apple is not responsible for the operation of this device or its compliance with safety and regulatory standards. Please note that the use of this accessory with iPod or iPhone may affect wireless performance.

iPhone and iPod are trademarks of Apple Inc., registered in the U.S. and other countries.

Safety Precautions

Please read through these operating instructions so you will know how to operate your model properly. After you've finished reading the instructions, keep this manual in a safe place for future reference.

Only connect the unit to a 12-volt power supply with negative grounding.

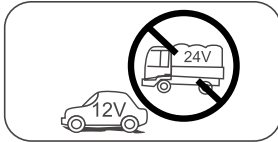

Never install this unit where the operation & condition for safe driving is impaired.

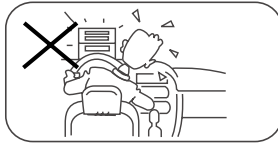

Never use the video display function in the front when driving to prevent the violation of laws & regulations and also to reduce the risk of traffic accident except for using rear view video camera.



Never expose this unit, amplifier, and speakers to moisture or water to prevent electric sparks or fire.

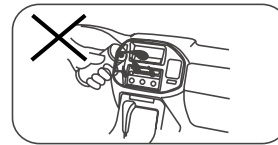

Please don't change the fuse on the power cord without professional guidance, using improper fuse may cause damage to this unit or even cause fire.

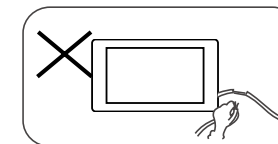

Please contact your nearest dealer if one of the following symptoms is experienced:

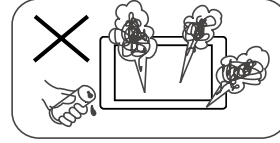

- (a). Water or other objects enters the unit.
- (b). There is smoke.
- (c). Peculiar smell.

To ensure safe driving, please adjust the volume to a safe and comfortable level in case of emergency situations.

- 1.) Never disassemble or adjust the unit without any professional guidance. For details, please consult any professional car shop / dealer for inquiry.
- 2.) If the front panel or TFT monitor is dirty, please use a clean silicone cloth and neutral detergent to wipe off the spot. Using a rough cloth and non-neutral detergent such as alcohol for cleaning may result in scratching or decoloration to the monitor.
- 3.) If any abnormal behavior of the unit is found, please refer to trouble shooting guide of this manual. If no relevant information is found, please press the [RESET] key on the front panel to resume factory default.
- 4.) If you have parked the car in hot or cold weather for a long time, please wait until the temperature in the car becomes normal before operating the unit.
- 5.) Using the car heater in low temperature environment may result in moisture inside the unit, DO NOT use the unit in this situation. Eject the disc and wipe off the moisture on the disc. If the unit still doesn't work after a few hours, please contact the service center.
- 6.) Do not impact the LCD monitor which could cause damage.
- 7.) To prevent damage to the screen, avoid touching it with sharp objects.
- 8.) To provide a clear demonstration and an alternative for easy understanding to the operation of this unit, graphic illustrations are used. However, some illustrations are different from the actual images displayed on the screen.
- 9.) Operate the unit correctly according to this manual to prevent unnecessary problem. The guarantee won't be valid if the problem is caused by inappropriate operation.

FEATURES

Please read the instruction manual for this product before using. The documentation provided will allow the user to fully enjoy all the features of your new Jensen VX3010 Mobile Multimedia Receiver. Please read all of the instructions before beginning the installation and save this manual for future reference. We recommend having your Jensen VX3010 installed by a reputable installation shop.

DVD

- Audio Equalizer
- Next Chapter and Previous Chapter
- Play/Pause
- Track Direct Entry
- Disc Menu
- Selection Repeat / Track Repeat
- Disc Audio
- Disc Language
- Pic Control

CD / MP3 / WMA

- CD-Text Compatible
- ID3 Tag Compatible
- Directory Search (MP3 / WMA Only)
- Audible Forward / Reverse Track Search
- Random, Repeat and Intro
- Play, Pause, Stop, Next Track and Previous Track

AM-FM

- USA, Asia, Japan, Europe, Eur LW, Oirt.
- 30 Station Presets (18 FM / 12 AM)
- Auto Stereo / Mono
- Local / Distance
- Auto Store

iPod®/iPhone®

- iPod®/ iPhone® via USB
- High Speed Direct Connect Interface to Access iPod® Playlists, Artists, Albums and Songs.
- Power Management Charges iPod® while Connected

Chassis

- 1.0 DIN (Import / ISO-DIN Mountable)
- Fixed Front Panel
- 7" High Definition TFT LCD
- 1,152,000 Sub Pixels (800 x 3 X 480)
- Beep Tone Confirmation (ON-OFF Option)

General

- Built-In Bluetooth® providing Hands-Free operation for safety and convenience and A2DP for streaming music from your smartphone or other Bluetooth® device.
- One Composite Video Output for Additional Screens
- Front Panel Audio/Video Input
- 3 Band Parametric Equalizer - Bass, Mid-Range and Treble
- Rear Panel Audio/Video RCA Input
- Front, Rear and Sub RCA Line Output - 2VRMS
- Rear Camera Input
- Touch Screen Calibration Mode
- Rotary Encoder Audio Control

REAR CAMERA

The VX3010 is "camera ready." Before accessing any camera features, you must purchase and install a rear video camera.

FRONT PANEL CONTROLS AND INDICATORS

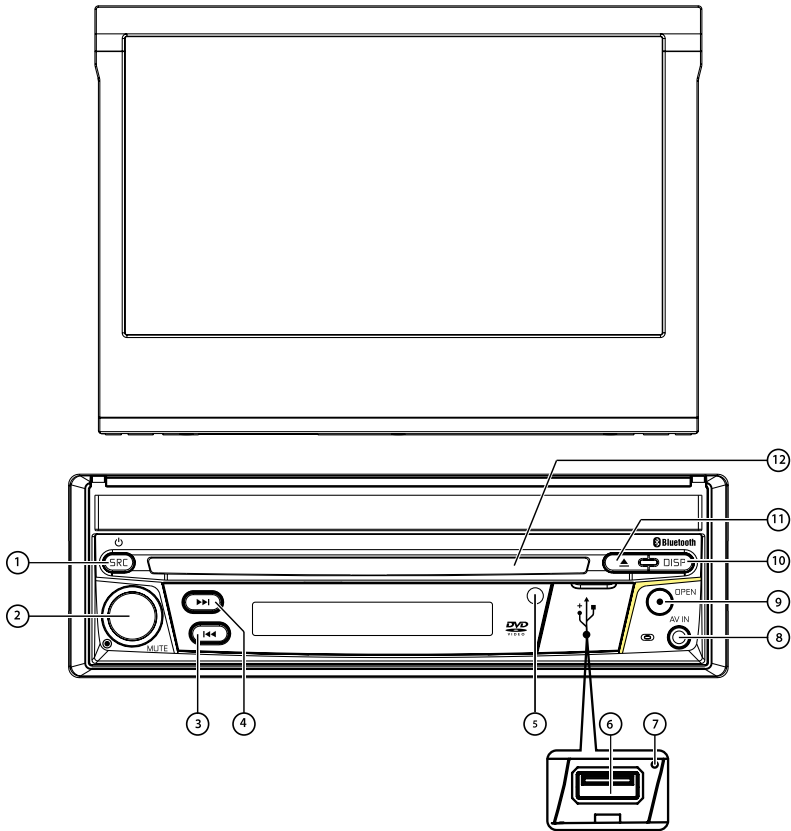

Figure 1. VX3010 Controls and Indicators

Notice:

The graphic in this manual is for reference only, and may be different from the actual unit. Reference to actual unit is suggested.

- 1.) SRC Button (Ⓞ) Power ON/OFF, and Source Menu:** Press the button to turn the unit ON. Once the unit is ON, momentarily pressing the [SRC] button will display the Main Touch Screen Source Menu. . Press and hold the knob for 2 seconds to turn the unit OFF.
- 2.) ROTARY ENCODER Knob:** Rotate the knob to adjust the volume from 0 to 50. Press the knob momentarily to mute the audio. Press the knob again to restore the audio.
- 3.) REVERSE [⏮] Button:** Press ⏮ to seek backward. With the radio mode, Press ⏮ to seek a lower station.
- 4.) FORWARD [⏭] Button:** Press ⏭ to seek forward. With the radio mode, Press ⏮ to seek a higher station.
- 5.) IR REMOTE SENSOR:** Used to receive command signals from the remote control.
- 6.) USB INTERFACE COVER:** Covers the USB interface connector. Open the cover and insert a USB device
- 7.) RESET Button:** Press this button to reset the system settings (except password and parental lock settings) and to correct a system halt or other illegal operation. Use the tip of a pen to press the Reset button.
- 8.) A/V INPUT:** Attach a compatible A/V device.
- 9.) TFT MONITOR [OPEN/CLOSE] Button:** Press to activate the automatic mechanical system and move the TFT monitor into the viewing position. Press again to close the TFT. With the monitor open, press and hold to enter display angle setting mode, and rotate the knob to adjust. Press and hold after adjustment, to save TFT position or let the feature time-out after 4 seconds.
- 10.) [DISP] Button:** With the monitor open, during DVD playback, press once to view Time, Title, Chapter info or twice for Audio, Subtitle, Angle, and Bit Rate info. With the monitor closed, press to view alternate LCD display information.
- 11.) EJECT [▲] Button:** Press this button to eject a DVD/CD/MP3 disc. Disc play is stopped, the disc is ejected and the unit will change to radio operation. If the disc is not removed from the unit and the button is pressed again, the disc will be re-loaded. If the disc is not removed from the disc slot within 10 seconds of being ejected, it will be automatically reloaded to prevent it from being accidentally damaged.
- 12.) DISC SLOT:** Accepts DVD/CD/MP3 discs. If the unit is turned on, playback begins when a disc is inserted.

REMOTE CONTROL OPERATION

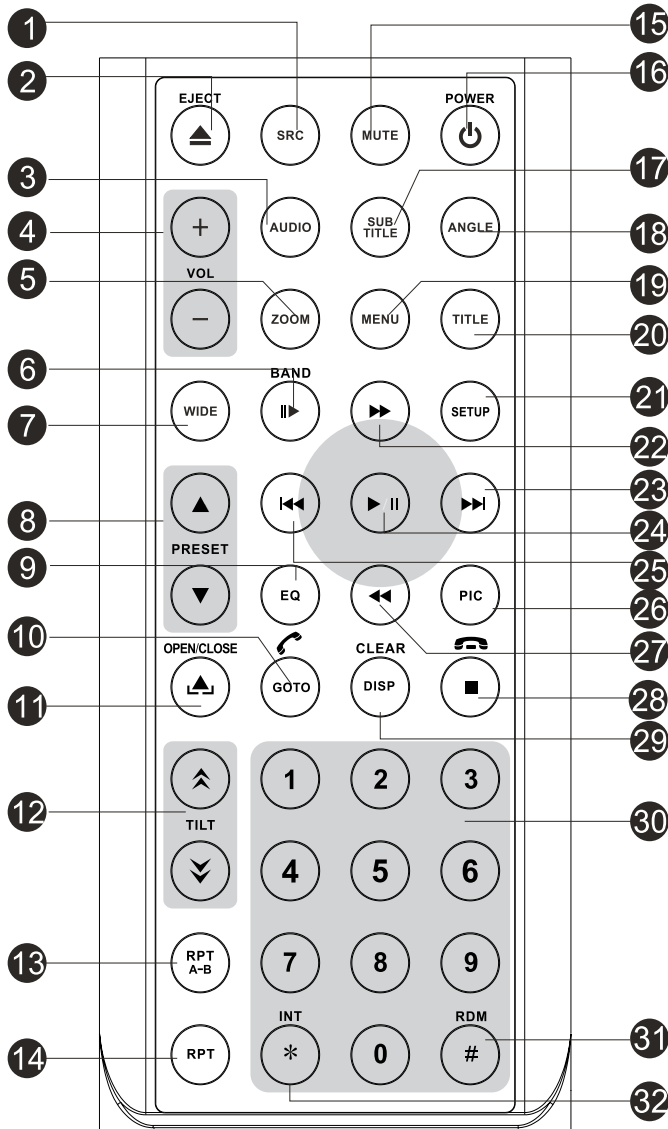

Figure 2. VX3010 Remote Control

Remote Control Functional Description

1. **SOURCE (SRC) Button:** Press this button to switch between and select available sources. (Radio/Disc/Bluetooth/USB/Bluetooth Audio/SWC/AUX-1/AUX-2/Camera)
2. **EJECT Button (▲):** Press this button to eject a DVD/CD/MP3 disc. Disc play is stopped, the disc is ejected and the unit will change to radio operation. If the disc is not removed from the unit and the button is pressed again, the disc will be re-loaded. If the disc is not removed from the disc slot within 10 seconds of being ejected, it will be automatically reloaded to prevent it from being accidentally damaged.
3. **AUDIO Button:** Press to display and select the audio language in DVD mode. Each time the button is pressed, the language changes.
NOTE: *The languages for audio vary from disc to disc.*
4. **VOLUME Button (VOL + and -):** Press these buttons to increase or decrease the playback volume.
5. **ZOOM Button (⏏): (FOR VIEWING IMAGE FILES)**

DISC images -

Press ZOOM button

- Once
- 2 times
- 3 times
- 4 times

CD Player Performs

- Enlarge the picture 125% of the original size
- Enlarge the picture 150% of the original size
- Enlarge the picture 200% of the original size
- Picture is returned to original size

SD Card images -

Press ZOOM button

- Once
- 2 times
- 3 times
- 4 times

SD Card Player Performs

- Enlarge the picture 100% of the original size
- Enlarge the picture 200% of the original size
- Enlarge the picture 300% of the original size
- Picture is returned to original size

6. **BAND Button:** Press this button to scroll though preset stations or when in disc mode, this button is used for Fast playback / Slow playback. Press this button to answer an incoming Bluetooth phone call.
7. **[WIDE] Button:** Change display mode.
8. **[PRESET ▲ / ▼] Button:** Select preset radio station.
9. **EQUALIZER Button (EQ):** Press this button to accesses the equalizer menu in all audio playback modes. **BLUETOOTH (BT) Button:** Press this button to enter the Bluetooth feature.

10. **GOTO Button:** Press this button to open direct entry search screen during the playback of a disc.
11. **[OPEN/CLOSE] Button:** Open / Close the TFT monitor.
12. **[TILT ^ / v] Button:** This button is used to adjusting the TFT Monitor tilting angle.
13. **[RPT A-B] Button:** A-B repeat.
14. **[RPT] Key:** Repeat playback
15. **MUTE Button:** Press this button to turn the audio output ON and OFF.
16. **POWER Button (⏻):** Press this button to turn the unit ON and OFF.
17. **SUBTITLE Button:** Press to display and select the subtitle language in DVD mode. Each time the button is pressed, the subtitle language changes.
NOTE: *The type and number of languages for subtitles vary from disc to disc.*
18. **ANGLE Button:** Press to display and select different camera angles in DVD mode. Each time the button is pressed, the angle changes.
NOTE: *The numbers of angles vary from disc to disc. Not all discs contain this option.*
19. **MENU Button:** – Press this button to access the root menu of a DVD or CD during playback. The disc will return to normal playback and the root menu will disappear if no selection is made within 10 seconds. This button is also used to select photo mode of an MP3 player.
20. **[TITLE] Button:** Used to display DVD Title.
21. **SETUP Button:** Press to this button to enter the system settings menu.
22. **FAST FORWARD [▶▶] Button:** Press this button to forward Disc play 2x, 4x, 8x or 20x normal speed. Press this button while in Radio mode to search available radio station by increasing tuning frequency.
23. **NEXT FORWARD (▶▶|) Button** – Press this button to skip to the next chapter, track or song during playback of a disc. Press this button while in Radio mode to search available radio station by increasing tuning frequency.
24. **PLAY / PAUSE (▶/||) Button:** Press this button to pause the playback of a disc. Press this button again to resume normal playback.
25. **PREVIOUS (|◀◀) Button** – Press this button to go back to the previous chapter, track or song during playback of a disc. Press this button while in Radio mode to search available radio station by increasing tuning frequency.

26. **[PIC] Button:** Image setting, press this button to adjust the Brightness/Contrast and Saturation.
27. **FAST REVERSE [▶▶] Button:** Press this button to reverse Disc play 2x, 4x, 8x or 20x normal speed. Press this button while in Radio mode to search available radio station by decreasing tuning frequency.
28. **[■ / ↶] Button:** Stop Playback / Hangup. Press this button to disconnect an active Bluetooth phone call.
29. **[DISP/CLEAR] Button:** Display information /Clear information.
30. **NUMBER Buttons (0-9):** Press these buttons to directly access chapters and tracks, dialing phone numbers, or entering passwords.
31. **RANDOM Button (#):** Press this button to play tracks or chapters in random order while playing a disc.
32. **[INT] Button:** Intro playback.

NOTES ON REMOTE CONTROL USAGE

- Aim the remote control at the remote sensor on the unit.
- Replace the battery from the remote control or insert a battery insulator if the battery has not been used for a month or longer.
- DO NOT store the remote control in direct sunlight or in high temperature environment, or it may not function properly.
- The battery can work for 6 months under normal condition. If the remote control won't work, please change the battery.
- Use "button shaped" lithium battery "CR2025"(3V) only.
- DO NOT recharge, disassemble, heat or expose the battery in fire.
- Insert the battery in proper direction according to the (+) and (-) poles.
- Store the battery in a place where children cannot reach to avoid the risk of accident.

Remote Control Battery Replacement

Install Battery

Use button-shaped lithium battery CR2025 (3V) only. Insert the battery to the battery tray with proper direction according to the (+) and (-) poles.

NOTE: Be sure and insert the positive (+) side of the battery UNDER the metal tab in the battery compartment.

Uninstall Battery

Slide out the battery compartment tray at the bottom on the back of the remote control.

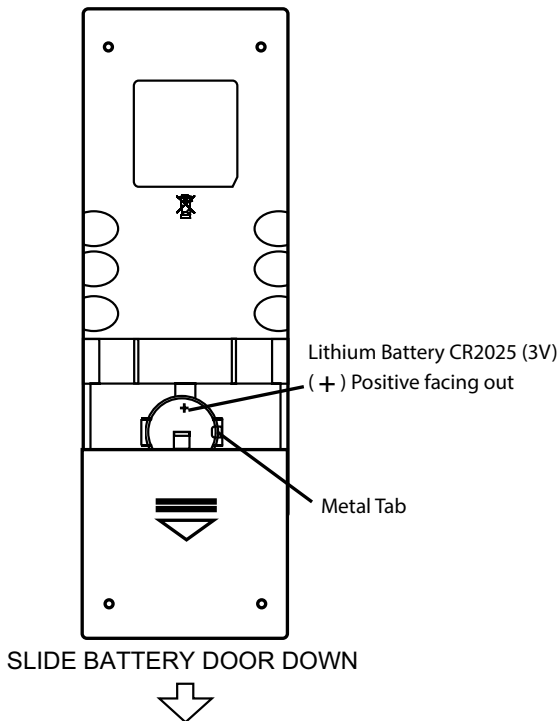

Figure 3. VX3010 Remote Control Battery Replacement.

QUICK START GUIDE

Turning the Unit ON or OFF

Press the front panel Power/Menu button [ / SRC] to turn the unit ON. To turn the unit OFF, press and hold the front panel Power/Menu button [ / SRC] for 2 seconds.

Selecting an Audio/Video Source, Bluetooth, Steering Wheel Controls or Backup Camera

To access an Audio/Video source:

1. Momentarily press the front panel Power/Menu button or touch the Menu icon  located in the upper left corner of the display to view the Main Menu Screen.

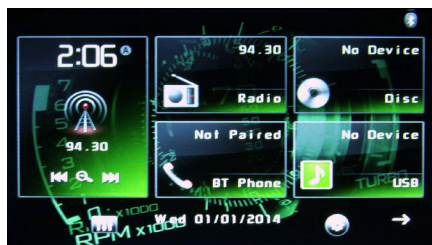
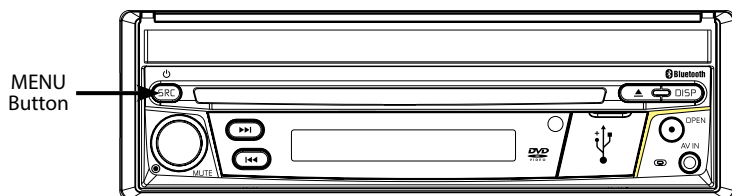

Screen 1



Screen 2

Figure 4. VX3010 Main Menu Screen

2. Touch the desired source icon on one of the two main menu screens. Screen 1 of 2: Radio, Disc, Bluetooth (BT), USB. Touch page arrow (-->) at the bottom of the screen to access Screen 2 of 2: Bluetooth (Audio), Steering Wheel Control (SWC), AV-IN1, AV-IN2, or Camera.

Mute

Press the volume knob on the front panel or press the [MUTE] Button on the remote control to mute the volume from the unit.

Volume Adjustment

Volume Increase/Decrease

To increase or decrease the volume level, turn the rotary encoder on the front panel. When the volume level reaches "0" or "50", a beep sounds, indicating that the adjustment limit has been reached. The TFT screen displays the volume level for 3 seconds.

Audible Beep Confirmation

An audible beep tone confirms each function selection. The beep tone can be disabled through the Setup menu.

Using the TFT Monitor

Open / Close monitor

Press the [OPEN] Button on the front panel or remote control to open or close the display panel. **NOTE: Never manually open or close the display panel.**

Change the monitor tilt angle

Due to the inherent character of LCD, you will get different vision impressions when you watch it from different angles. The display angle of this unit can be changed; hence you can select the best angle where you can get the best vision impression. Press and hold the [OPEN] Button to enter display angle setting mode, and rotate the knob to adjust. **NOTE: Never manually tilt the display panel.**

Resetting the System

Soft Reset - To correct a system halt or other illegal operation, use the tip of a pen to press and release the reset button located just below the front panel control knob.



Figure 5. System Reset Button

For a Hard Reset- Touch the System Reset Icon on the Third Settings Screen. After a system reset, the unit restores all factory default settings.

NOTE: If the unit is reset while a DVD is playing, the unit will return to Main Menu once the reset is complete.

Change Aspect Ratio

Press the [WIDE] key on the remote control to adjust the aspect ratio.

Image Settings

1. Enter image setting mode by pressing the [PIC] Button on the remote control.
2. Select the item to be adjusted and touch the Left or Right direction icons [◀] / [▶] on the user interface to adjust the value.
3. To exit image setting mode, press the [PIC] Button on the remote control again or simply stop making adjustments.

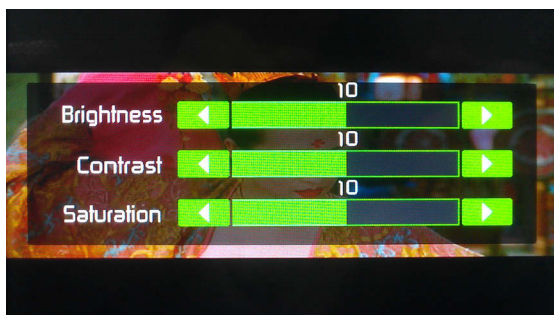

Figure 6. Image Settings Screen

Equalizer Controls

Equalizer (EQ): Adjustment can be made after entering one of the audio/video sources (Disc, Radio, USB, AV-IN1, or AV-IN2). Touch the Equalizer (EQ) icon to view the Equalizer Control Screen to select a desired audio preset level (Pop / Techno / Rock / Classic / Jazz / Optimal or User), make adjustments to the audio Balance and Fade levels or to turn the Loudness option ON or OFF. Touch the return icon to return to the current source.

Playing a Disc



To begin playback of an Audio/Video Disc:

1. Press the front panel Power/Volume/Mute control knob to turn the unit ON.
2. Insert a disc with the label side facing UP and playback will begin automatically.

Parking Brake Inhibit

When the pink "Parking" wire is connected to the vehicle Parking Brake circuit, the front TFT monitor will display video when the Parking Brake is engaged.

SYSTEM SETTINGS

1. Touch the Menu icon  located in the upper left corner of the display to display the main menu.
2. Touch the Settings icon  and the settings menu is displayed.

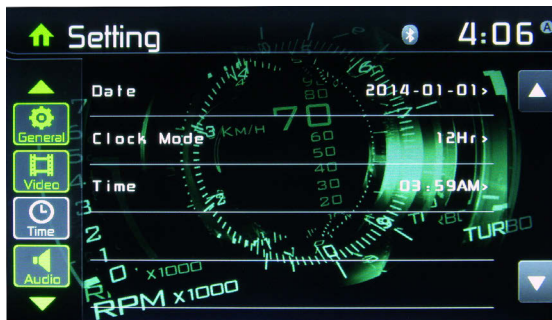



Figure 7. Settings Menu Screen

General Settings

1. Touch [General], if necessary.
2. Touch to highlight a setting to display/select an option.

General settings	Options	Description
Radio region	USA/Asia/Japan/Europe/Eur LW/Oirt	Select one that matches your location.
Radio range	Local	Select Local to receive only stations with extremely strong signal.
	Distance	
Beep	On	Turn-ON the beep sound. Each time you press a button, the unit beeps.
	Off	Turn-OFF the beep sound.
Calibration	Start	Calibrate the touch screen.
Demo	On	Turn-ON Retail Demo Mode.
	Off	Turn-OFF Retail Demo Mode

4. Touch Menu icon  located in the upper left corner of the display to exit.

Calibration

Calibrate the touch screen using the calibration setting function.

Recalibrating the touch screen:

1. Press the [Calibration] option on the setup menu to enter.
2. Touch [Yes] to enter.
3. Press and hold the center of [+] for 5 seconds, the [+] will move automatically.
4. Aim at center of [+], follow the path as shown in the figure. Once steps 1-4 are complete the system will automatically exit calibrating mode.

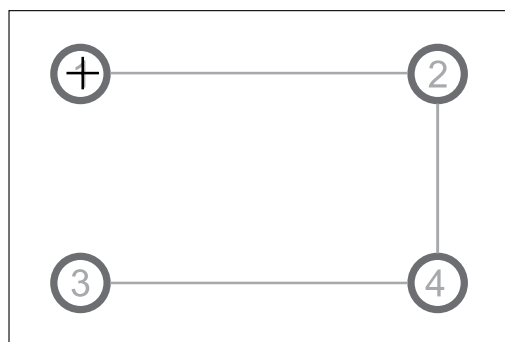

Figure 8. Calibration Screen

Video Settings

1. Touch [Video].
2. Touch an option repeatedly to select.

Video settings	Options	Description
Aspect Ratio	Full	Adjust aspect ratio.
	Normal	
Rear Camera	Mirror	Reverse the camera image as if looking through a rear-view mirror.
	Normal	

3. Touch the return icon to exit and return to the previous screen.

Time Settings

1. Touch [Time].
2. Touch an option repeatedly to select:

Time settings	Options	Description
Date	Year / Mon / Day	Touch [▲] or [▼] to set year, month and day.
Clock mode	12Hr/24Hr	Touch [12Hr] or [24Hr] to switch clock mode.
Time	Hour / Min / AM / PM	Touch [▲] or [▼] to set hour and minutes. Touch [▲] or [▼] to set AM/PM (only for 12Hr).

3. Touch the return icon to exit and return to the previous screen.

Audio Settings

1. Touch [Audio].
2. Touch an option repeatedly to select.

Audio settings	Options	Description
Sub woofer	ON	Turn-ON the subwoofer.
	OFF	Turn-OFF the subwoofer
Sub woofer filter	80Hz	Select a crossover frequency to set a cut-off frequency for the subwoofer's LPF (low-pass filter).
	120Hz	
	160Hz	
L o u d n e s s	OFF	Select low frequency boost only or high and low frequency boost.
	Lo Boost	
	Hi&Lo	
L o u d n e s s Center	400Hz	Select loudness center frequency.
	800Hz	
	2.4KHz	

3. Touch the return icon to exit and return to the previous screen.

Language Settings

1. Touch [Language].
2. Touch an option repeatedly to select.

Language settings	Description
OSD	Select on-screen display language.
DVD audio	Select DVD audio language. Options available depending on DVD disc.
DVD subtitle	Select DVD subtitle language. Options available depending on DVD disc.
DVD menu	Select DVD menu language. Options available depending on DVD disc.

3. Touch the return icon to exit and return to the previous screen.

Bluetooth Settings

1. Touch [Bluetooth].
2. Touch an option repeatedly to select.

Bluetooth settings	Options	Description
Bluetooth	ON	Turn-ON the Bluetooth function.
	OFF	Turn-OFF the Bluetooth function.
Auto connect	ON	If the pre-paired device is within the effective range, the unit re-connects to pre-paired device automatically.
	OFF	Need to re-connect manually.
Auto answer	ON	Answer paired phone call automatically.
	OFF	Answer phone call manually.
Pairing code	Set the password for pairing the unit with other Bluetooth device.	

3. Touch the return icon to exit and return to the previous screen.

DVD Rating

1. Touch [DVD].
2. Touch an option repeatedly to select.

DVD rating	Options	Description
Set password	Set password to restrict the play of discs. The default password is 1234.	
Rating level	Kid safe	Acceptable for children.
	G	Acceptable for general viewers.
	PG	Parental guidance suggested.
	PG-13	Unsuitable for children under age 13.
	PG-R	Recommend parents to restrict viewing for children under 17.
	R	Restricted re-parental guidance is advised for children under the age of 17.
	NC-17	Unsuitable for children under age 17.
	Adult	Acceptable for adults only.
Load factory	Restore to default settings.	
Version Info	The Version Sub-menu is used to identify the model and resident operation system as well as the hardware and software versions.	

3. Touch the return icon to exit and return to the previous screen.

Adjust Volume Settings

You can set different volumes for different sources.

1. Touch the [Volume] icon to display and access the volume setting sub-menu
2. Touch the source to be adjusted.
3. Touch [▲] or [▼] to assign value: 0 to 12. When switching to the source, the volume increases automatically.
4. Touch the return icon to exit and return to the previous screen.setting menu.

RADIO TUNER MODE

Select radio as playing source

Open the SOURCE MENU and then touch [Radio].

Selecting a Radio Band

Press the [BAND] Button on the remote control or touch the [📶] icon on the user interface to select one radio band among FM1, FM2, FM3, AM1 and AM2.



Figure 9. Radio Screen

Tune

Auto Tuning

Press the [▶▶] / [◀◀] Buttons on the remote control or touch the [▶▶] / [◀◀] icons on the user interface to seek a higher / lower station.

To stop searching, repeat the operation above or press other Buttons having radio functions. **NOTE:**When a station is received, searching stops and the station is played.

Manual Tuning

Method 1:

Press and hold the [▶▶] or [◀◀] icon for 1 second to enter Manual Tuning mode. During manual tuning, the frequency will be changed in steps.

Touch the [▶▶] / [◀◀] icon on the user interface to tune in a higher / lower station.

Method 2:

1. Touch the numeric keypad icon [🔢]. Numeric keyboard is displayed, touch numbers to input frequency.
2. Touch [✕] to delete the input numbers step by step.
3. Touch [OK] to enter.

Preset Station

The unit has 5 bands, such as FM1, FM2, FM3, AM1, AM2, and each band can store 6 stations; hence the unit can store 30 stations in total.

Manual Store

1. Tune to a desired station.
2. Touch and hold one of the presets (1 to 6) to save the selected station.



Search Stations Automatically

Touch the search icon [] to search stations and store the 6 strongest stations in the current band automatically.

Recalling a Station

1. Select a band.
2. Touch an on-screen preset button to select the corresponding stored station.

Local radio station seeking (LOC)

When the Local function is on, only radio stations with a strong local radio signal are played. To activate the Local function in the AM/FM tuner mode, touch [] on the screen. The Options tab is revealed. Touch [] icon and choose the Radio Local or Distance. When the Local function is active, the LOC indicator at the top of the screen is illuminated. When the Distant function is active, the DX indicator at the top of the screen is illuminated.

EQ Selection

Touch the Equalizer [] icon and enter the EQ setup.

RDS

RDS(Radio Data System) transmits data to the radio which displays information such as station identification, song artist, and song title.

RDS service availability varies with areas. Please understand if RDS service is not available in you area, the following service is not available.

Adjust RDS Settings

1. In Radio menu, touch [] and [Option].The option menu is displayed.
2. Touch on the selected option to change the setting.
 - [RDS]: To turn the "RDS" function ON or OFF.
 - [CT]: To turn on or off "Clock Time" synchronization function.
 - [PTY]: To show PTY list.

CT (Clock Time)

Some stations broadcast the time and date within the encoded RDS signal. The clock time is automatically adjusted when 'CT' is set to 'ON'.

Note: *Stations broadcasting close to time zones may not broadcast the correct time in your particular area. In this case, turn CT Off and manually set the time.*

PTY Function

PTY is the abbreviation for Program Type which is the function that displays the program category of the current station such as category (news, sports, talk etc.) Use the scroll bar to select various category codes.

Once a category code is selected the PTY options will display on the screen.

When one PTY option is touched (e.g. News), auto search for next available PTY by increasing tuning frequency until the PTY of the next station matches the current. If no matched PTY has been found, the unit will return to the original radio frequency.

PLAYBACK OF AUDIO FILES

Compatible Audio Discs Types

This system will play the following types of discs:

- DVD - DVDs that contain audio and/or video.
- Audio discs - Audio CDs that contain audio, video and image files.
- MP3 discs - A disc that contains audio, video and image files (for example, a CD-R with downloaded MP3 files).

NOTE: This unit is designed to play pre-recorded (original) CD/DVDs. Some burned CD / DVD's may not play due to different recording formats.

DVD Operation

DVD Main Menu

NOTE: When properly installed, DVD video cannot be displayed on the main TFT screen unless the parking brake is applied. If you attempt to play a DVD while the vehicle is moving, the TFT screen displays:

Warning!!!

It is illegal to view video while driving or operating a motor vehicle. Set parking brake to view video.

From the Main Menu Screen touch the DISC Icon or insert a disc into the disc slot, label side up. Playback begins when a disc is inserted correctly.

Insert a disc

Upon inserting a disc, the unit will switch to [DISP] mode automatically.

Eject the disc

Press the [▲] key on the front panel or remote control to eject the disc.

Touch screen controls

The touch key areas for DVD playback are outlined below:

- A: Return to the main menu
- B: Disc type
- C: Time display
- D: Play the video and display playback information
- E: Display onscreen control menu

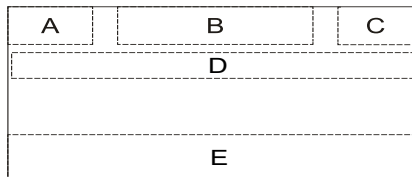

Figure 10. Screen Control Areas

Controlling Playback

To access the on-screen controls, touch the screen anywhere except for the upper left corner and touch again to cancel display.

Connect an USB Device

1. Open the USB door.
2. Connect an USB device into the USB connector. Play starts automatically.

NOTES:

1. *If there are audio files supported on the USB stick, the system will enter the audio files menu automatically.*
If there are no audio files, but there are video files supported on the USB stick, the system will enter the video files menu automatically.
If there are no audio or video files, but there are picture files supported on the USB stick, the system will enter the picture files menu automatically.
If there are no audio/video/picture files supported in the USB stick, the screen will display: There are no audio/video/picture files supported.
2. *Not all USB devices are compatible with the unit.*

Play

Once a disc, or a USB device is inserted, play starts automatically.

Pause

When play the audio/video file, press the [▶||] key on the remote control or open the on-screen control icons menu and then touch the [▶||] icon, press the [▶||] again and continue to play.

Stop

For audio files or video files, press the Stop [■] Button on the remote control or open the on-screen control icons menu and then touch the Stop [■] icon to stop. Press the [▶||] to resume from the pausing point. Touch the Stop [■] icon again to stop entirely, and press the Stop [■] Button on the remote control. Press the [▶||] to playback from the top file.

Previous/Next

Touch [⏮] / [⏭] key on the screen to skip to previous / next track / chapter.

Search for a Folder

For Folder Control

1. Touch [📁] to display all available folders.
2. Touch a folder, then touch the desired file.
3. Touch the file again to start play.

For Audio Files

1. Touch [🎵] to display all available audio folders.
2. Touch a folder, then touch the desired file.
3. Touch the file again to start play.



Figure 11. Folder Screen

1/16/2014 1:18:42 PM

Video Files

1. Touch Video icon [] to display all available video folders.
2. Touch a folder, then touch the desired file.
3. Touch the file again to start play.

Picture Files

1. Touch Picture icon [] to display all available picture folders
2. Touch a folder, then touch the desired file.
3. Touch the file again to start play.

Repeat playback

Press the Repeat [RPT] Butto on the remote control or open the on-screen control icons menu and then touch the Repeat[] icon to switch the repeat modes as below:

Disc type	Repeat mode
DVD	Repeat chapter → Repeat title → Repeat all → Repeat off
VCD(PBC off)	Repeat one → Repeat all → Repeat off
CD	Repeat one → Repeat all → Repeat off
MP3/WMA	Repeat one → Repeat folder → Repeat all → Repeat off
MPEG	Repeat one → Repeat folder → Repeat all → Repeat off
Picture	Repeat one → Repeat folder → Repeat all → Repeat off

Figure 12. Repeat Mode

Repeat A-B

When a DVD, VCD is played back, you can play back the contents between the time points from A to B repeatedly:

Repeat A- → Repeat A-B → RepeatA-B Off

Figure 13. Repeat A-B ON and OFF

Random Play

You can play audio tracks/files in random order. During play CD,press the [RDM] key on the remote control repeatedly to turn Random play ON or OFF.

NOTE:

When [Shuffle] is off, the unit resumes play from the current sequence.

Playback Control function

This function is available for the VCD discs with Playback Control function (Ver 2.0 or higher). Press the [MENU] Button on the remote control or open the on-screen control icons menu and then touch the [] icon repeatedly to activate this function.

Press again to cancel.

Notes:

1. When Playback Control is ON, playback goes back to the track list and starts from the first track.
2. When Playback Control is on, fast motion playback, slow motion playback or skip search is available but repeat playback and searching for a particular chapter or track is prohibited.
3. If you use random playback, scan playback or searching playback when Playback Control is ON, Playback Control will be OFF automatically.

Select Audio Mode

When playing VCDs, the user can select an audio mode (R/L/Stereo).

1. During playback, touch the bottom half of the screen to display menu on the screen.
2. Touch the Next icon [⏮] to display the 2nd menu.
3. Touch the Audio icon [🔊] repeatedly until the audio mode is selected.

Select Subtitle Language

For DVD discs that contain two or more subtitle languages.

1. During play, touch the screen to display menu on the screen.
2. Touch the Next icon [⏮] to display the 2nd menu.
3. Touch the Language icon [🗨️] repeatedly to select a language. The selected language is displayed.

Change Viewing Angle

Some DVDs contain alternate scenes, such as scenes recorded from different camera angles.

For such DVDs, you can select from the available alternate scenes.

1. During playback, touch the screen to display menu on the screen.
2. Press the Angle icon [📐] repeatedly on the remote control. The viewing angle is changed.

Video Setup

Touch the Settings icon [⚙️] to access video setup mode, touch Left or Right direction icons [⬅️]/[➡️] to set the desired effect. You may set the brightness, contrast, and saturation of the video output from 1 to 20.

Playback Information

Touch the screen during playback of a DVD or VCD disc and the playback information will be displayed on the top area of the TFT.

For DVD

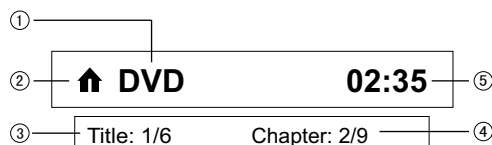

Figure 14. DVD Information Display

1. Disc type.
2. Return to the main menu.
3. DVD Title information. "1/6" indicates that this DVD has 6 titles and the title playing back now is the first title.
4. DVD Chapter information. "2/9" indicates that current title has 9 chapters and the chapter playing back now is the fifth chapter.
5. Time display.

For VCD

1. Disc type.
2. Return to the main menu.
3. VCD Track information. "1/16" indicates that this VCD has 16 tracks and the track playing back now is the first title.
4. Time display.

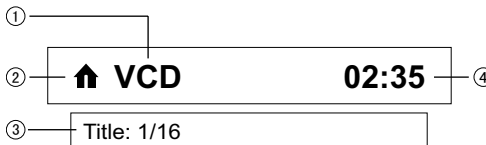

Figure 15. VCD Information Display

Elapsed Time

1. Elapsed time of the current track.
2. Total time of the current track.



Figure 16. Elapsed Time Display

Direct Track Entry

To select a track directly, touch the [] icon on screen control to display the direct entry menu. Enter the desired track using the on-screen number pad. Press [OK] to the selected track.

Rotate Pictures

1. When viewing pictures, touch the screen to display menu on the screen.
2. Touch the Rotate Icon [] repeatedly to rotate the picture.

Zoom

The user can zoom in pictures for a close view.





1. When viewing pictures, touch the screen to display menu on the screen.
2. Touch [] repeatedly to zoom in the picture.







Figure 17. Zoom

General Disc Information

Disc Properties

Symbol	12cm Disc Properties	Max Play Time
	Single side single layer (DVD-5) Single side double layer (DVD-9)	(MPEG 2 Method) 133 minutes
	Double side single layer (DVD-10) Double side double layer (DVD-18)	242 minutes 266 minutes 484 minutes
	Single side single layer (VCD)	(MPEG 1 Method) 74 minutes
	Single side single layer	74 minutes

Disc Symbols

Symbol	Meaning
	Number of voice languages recorded. The number inside the icon indicates the number languages on the disc (maximum of 8).
	Number of subtitle languages available on the disc (maximum of 32).
	Number of angles provided (maximum of 9).
	Aspect ratios available. "LB" stands for Letter Box and "PS" stands for Pan/Scan. In the example on the left, the 16:9 video can be converted to Letter Box video.
	Indicates the region code where the disc can be played. <ul style="list-style-type: none"> • Region 1: USA, Canada, East Pacific Ocean Islands • Region 2: Japan, Western Europe, Northern Europe, Egypt, South Africa, Middle East • Region 3: Taiwan, Hong Kong, South Korea, Thailand, Indonesia, South-East Asia • Region 4: Australia, New Zealand, Middle and South America, South Pacific Ocean Islands/Oceania • Region 5: Russia, Mongolia, India, Middle Asia, Eastern Europe, North Korea, North Africa, North-West Asia • Region 6: Mainland China • ALL: All regions

EQUALIZER CONTROL MENU

Adjusting Equalizer Controls

The Equalizer adjustment screen allows the user to easily adjust the audio system to meet the acoustical characteristics of the vehicle depending on vehicle type and cabin dimensions. **For example:** proper setting of the audio controls can improve the speakers frequency response.

The Balance/Fade levels and Loudness ON/OFF option of a selected audio/video source (Disc, Radio, USB, AV-IN1, or AV-IN2) is also adjusted through the Equalizer adjustment screen.

Equalizer (EQ)

1. Touch the Equalizer (EQ / ) icon to view and select a desired acoustical preset level (Pop / Techno / Rock / Classic / Jazz / Optimal or User) **NOTE: The equalizer will automatically change to "USER" when individual audio functions are adjusted.**

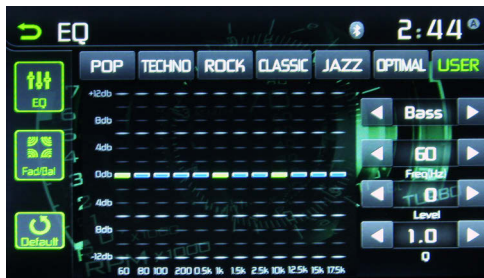

Figure 18. Equalizer (EQ) Screen

Adjusting the Fader and Balance

The user can adjust front/rear fader settings, L/R balance settings, and subwoofer levels here.

1. Enter the EQ setup mode.
2. Touch the [EQ] icon in the EQ interface menu.



Figure 19. Fade-Balance Adjustment Screen

Balance- This feature is used to balance the audio output levels between the left and right side of the vehicle. Touch the ◀ or ▶ icons to change the balance control settings -12 (Left) to +12 (Right). The setting can also be changed by touching screen within the grid to move the blue sphere.

Fader- This feature is used to fade the audio output levels between the front and rear of the vehicle. Touch the ▲ or ▼ icons to change the fade control settings -12 (Rear) to +12 (Front). The setting can also be changed by touching screen within the grid to move the blue sphere.

Sub (Subwoofer)- This feature is used to reduce or increase the subwoofer sound level. Touch the slide bar ◀ or ▶ icons to adjust the subwoofer volume from -12 to +12. This setting will vary depending on the input level setting of your subwoofer amplifier.

To exit the balance-fader touch the return icon on the top left corner of the screen.

NOTE:

- *The EQ mode will change to 'User' automatically when you adjust the frequency value in all modes besides 'User'.*

iPod®/iPhone® CONTROLS

Accessing iPod® Mode

The user can control an iPod®/iPhone® using the touch screen to access, albums, songs, videos, etc.

NOTE: For basic connectivity, the iPod®/iPhone® must be connected to the unit using the iPod®/iPhone® adapter cable that came with the iPod/iPhone (also available separately). For iPod®/iPhone® video playback, use a jLink USB cable, equipped with a USB connector and a 3.5 mm AV jack. Be sure your iPod®/iPhone® has the latest Apple firmware installed to avoid connectivity issues.

The unit will automatically switch to iPod® mode when an iPod®, iPod® touch or iPhone® is plugged into the front panel USB connector. Also the iPod® can be accessed from the Main Menu Screen by touching the iPod® icon (only available when an iPod® or iPhone® is connected to the front panel USB connector)

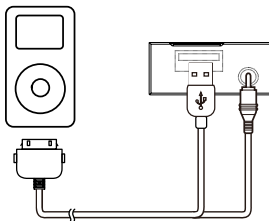

Figure 20. Connecting the iPod®/iPhone®

iPod®/iPhone® Main Menu

To access the iPod® mode touch [iPod] on the main menu to enter iPod® menu. Access iPod menu from here. Touch ▲ or ▼ icons to browse menu.



Figure 21. iPod®/iPhone® Menu

1. Return to main menu / 2. File list Drag up/down to scroll / 3. Show Music files
4. Show Video files / 5. Show Photo files

Note: Apple has removed video playback and photo browse from iPhone 5 and iPhone 5S.

Pausing Playback

1. Touch the Pause icon [⏸] on the bottom of the screen to pause play. "PAUSE" appears in the display, and Pause icon [⏸] will switch to a Play icon [▶].
2. Touch the Play icon [▶] to resume playback.

Selecting a Track

Track-up

Touch the Forward icon [⏭] to move to the beginning of the next track.

Track-down

1. Touch the Back icon [⏮] once to move back to the beginning of the current track.
2. Touch the Back icon [⏮] twice to move back to the beginning of the previous track.

Fast Forward/Fast Reverse

Fast forward

Touch and hold the Forward icon [⏭].to fast forward a track.

Fast reverse

Touch and hold the Back icon [⏮]to fast reverse a track.



Figure 22. iPod®/iPhone® Play/Pause and Track Controls

Repeat Play

This function allows the user to play the track repeatedly by touching the Repeat icon [↺] to select Repeat one or Repeat all.

Random play

This function allows the user to play all tracks recorded in a random order by touching the Random icon [⏮] to perform random play.



Figure 23. iPod®/iPhone® Repeat Play and Random Play Controls

BLUETOOTH® OPERATION

Bluetooth® was launched by a special interest group (SIG) comprised of Ericsson Inc., Intel Corp., Nokia Corp., Toshiba and IBM in 1998, and it is currently developed by nearly 2,000 companies worldwide. The Bluetooth® word mark and logos are owned by the Bluetooth® SIG, Inc. and any use of such marks by Jensen Corporation is under license. Other trademarks and trade names are those of their respective owners.

Bluetooth® technology has the capability to wirelessly synchronize and transfer data among devices. The Bluetooth® audio capabilities can be used for mobile phones hands free applications. Bluetooth® has many profiles and the unit is compatible with most Bluetooth® enabled mobile phones. Before attempting to use the Bluetooth® functions on the unit, please make sure your mobile phone supports Bluetooth® functions.

NOTE: *The line-of-sight distance between this unit and your mobile phone must be 8 feet (2.4 meters) or less for sending and receiving voice and data via Bluetooth® wireless technology.*

Please make sure your mobile phone supports Bluetooth® functions (Headset or Handsfree profiles or both). Adhere to the following guidelines for successful operation.

- Before using Bluetooth® functions, you must pair your mobile phone to the VX3010 unit (see “Pairing the Bluetooth® System with Your Mobile Phone and Unit”). To ensure the best reception for pairing and re-connection, please make sure the mobile phone battery is fully charged before you begin.
- Try to perform pairing within a few minutes of the mobile phone being turned on.
- Once the unit has been paired with the mobile phone, the unit’s model number, “VX3010”, will be displayed on the mobile phone.
- To achieve the best performance, always keep the mobile phone within 10 feet (3 meters) of the unit.
- Always keep a clear path between the mobile phone and the unit. Never place a metal object or any other obstacle between the mobile phone and the unit.
- Some mobile phones may have a “Power Saving Mode” option. PLEASE DO NOT use the power saving mode with the VX3010.
- Before accepting or making a call, make sure your mobile phone’s “Bluetooth® function” is turned on.
- To ensure the best conversation quality/performance, stay within 3 feet (1 meter) of the units microphone when talking.
- To manually disconnect the mobile phone from the unit, touch the “Chain Link” icon on the Bluetooth® user interface (next to the mobile phone name) and the Bluetooth® device will be “disconnected”, but still paired.

The user can make or receive phone calls with Bluetooth® enabled phones through the unit. The user can also listen to music from a Bluetooth® enabled device.

Pairing Bluetooth® Enabled Devices

To connect your Bluetooth® phone to the unit, the user needs to pair the phone to the unit. Pairing needs only to be done once. The user can pair up to five phones. The user can search for Bluetooth head units by mobile phone.

1. Turn ON the Bluetooth® function on the device.
2. Search for Bluetooth® devices by mobile phone.
3. Select the Bluetooth® device ID "VX3010" in the pairing list.
4. Enter default password "0000".

NOTES:

- The operational range between this unit and a Bluetooth® device is approximately 5 meters.
- Before you connect a Bluetooth® device to this unit, familiarize yourself with the Bluetooth® capabilities of the device.
- Compatibility with all Bluetooth® device is not guaranteed.
- Any obstacle between this unit and a Bluetooth® device can reduce the operational range.
- Keep this unit away from any other electronic device that may cause interference.



Figure 24. Bluetooth® Menu

Disconnecting a Bluetooth® Device

To disconnect one device, touch [Disconnect]. After "Disconnect" is pressed, the radio will display a screen listing paired devices. Pressing the Green "Plug" icon will reconnect a previously paired phone to the BT radio. Pressing the "Wastebin" icon next to a device's name will unpair the phone from the radio.

NOTES.

- The device will be disconnected when the device is moved beyond the operational range.
- If you want to reconnect the device to the unit, place it within the operational range.
- If you do not want to reconnect the device to the unit automatically, touch [Options], then set [Auto connect] to [OFF].
For details, see the "Adjust Bluetooth® Settings" section.



Figure 25. Bluetooth® Entry Pad and Option Screen

Making a Call

1. Select Bluetooth® function in the home menu.
2. On Option page, see the "Phone Synch" item, and press "Synch" to synchronize the phone book with the BT. If you have many contacts, this may take up to 3-4 minutes.
3. Search for phone number from the following list:
 - [Phone Book]
 - [Call History]
 - [Missed calls]
 - [Received calls]
 - [Dialed calls]

Or touch the number pad directly, then touch [] to dial.



Figure 26. Bluetooth® Call Log Controls

Receiving a Call

By default, all incoming calls are received automatically.

1. If there is an incoming call, the screen will display “Incoming call...”.

2. Touch the screen to select [hang up] or [Answer].

Speak into the Bluetooth microphone.

Tip

- You can select to receive calls manually by setting [Auto answer] to [OFF]



Figure 27. Bluetooth® Incoming Call Screen

Adjust Bluetooth Settings

1. In Bluetooth menu, touch [Options].

The option menu is displayed.

2. Touch on the selected option to change the setting.

- [Bluetooth]: To turn the “Bluetooth” function ON or OFF.
- [Auto connect]: To turn the “Auto Connect” function ON or OFF .
- [Auto answer]: To turn the “Auto Answer” function ON or OFF .
- [Pairing code]: To set the paring code.
- [Phone sync]: To synchronize phone book, touch [OK] on the sub-menu Phonebook Synch may take several minutes to load on initial setup.

NOTE:

- You can also adjust Bluetooth settings in the “Settings” menu.



Figure 28. Bluetooth® Settings Menu

Bluetooth® Music Function

Bluetooth® provides an Advanced Audio Distribution Profile (A2DP) profile for streaming music from a mobile phone or a portable multimedia player (PMP), sometimes referred to as a MP3 player. The unit allows you to play back audio files from your mobile phone or a PMP using a Bluetooth® connection.

NOTE: *Please quit A2DP mode before attempting to make a phone call, as unexpected results may occur depending on your mobile phone model.*

AVRCP is short for Audio/Video Remote Control Profile. Mobile phones supporting this function can control the playback of a Bluetooth audio player.

The unit can control a Bluetooth® audio player via Advanced Audio Distribution Profile (A2DP) or Audio/Video Remote Control Profile (AVRCP). Bluetooth® audio players (or Bluetooth® adapters) compatible with these profiles can be connected to this unit.

While listening to music from any source, the user can make a phone call by pressing the number keys on the mobile phone. The unit will stop playing music and the TFT screen will display "Calling", after the call received, the voice will be transferred to the unit. When the call ends, the screen will display music playing menu.

If there is an incoming phone call, the music will stop, and the screen will display "Incoming". When the call ends, the screen will display music playing menu.



Figure 29. Bluetooth® Audio Menu

AV-In1/AV-In2 CONTROLS

AV-In1

AV-In1 is used for playback of audio/video from an external device connected to the unit through a 3.5mm jack located on the front panel.

AV-In2

AV-In2 is used for playback of audio/video from an external device connected through RCA connectors located on the back of the unit.

You can connect an external audio/video device to the unit.

1. Connect the external device with an appropriate AV cable.
2. Touch the upper left corner to display the main menu.
3. Touch [Aux 1] / [Aux 2] to access external device.

NOTE: Audio/Video device must be connected to the unit using an audio/video adapter cable that is available separately.

NOTE: Video will only play when the vehicle parking brake is engaged. The parking brake must be connected for this feature to operate.

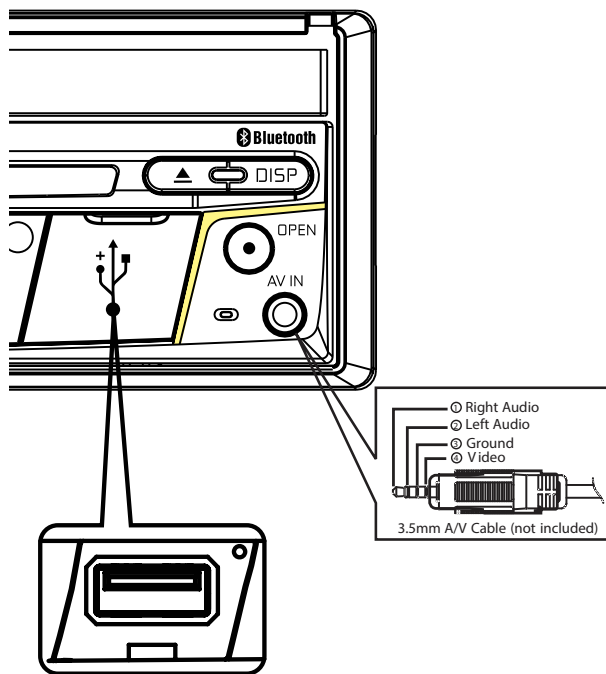

Figure 30. Connecting External Devices

BUILT-IN SWC INTERFACE

The built-in SWC Interface is compatible with most vehicles equipped with “resistive type” OE steering wheels.

Note: *Not all OE steering wheel functions may be supported by the VX3010.*

The following controls are available for most vehicles:

1. Volume Up (+)	4. Seek Up (Next)	7. Preset (+)	10. Answer
2. Volume Down (-)	5. Seek Down (Prev)	8. Preset (-)	11. BT Send
3. Mute	6. Source	9. Band	12. BT End

To access the SWC Controls for programming, touch the Steering Wheel icon on the second page of the Main Source Menu.



Figure 31. SWC Programming Screens

SWC Programming

Up to 12 steering wheel control functions can be programmed via the built-in SWC interface. Not all functions may be supported for each vehicle.

1. Popular OE steering wheel functions are already pre-programmed from the factory. If your vehicle does not support the exact same functions already pre-programmed, you will need to clear / reset the SWC interface and program in the exact functions of your vehicle. To clear / reset the SWC interface, press and hold “Reset” for 2 seconds.
2. To begin programming the SWC interface after it has been cleared / reset, press a number 1 ~ 12, then press a function. A check mark should appear corresponding to the number and function. Continue programming in this manner until all of the OE steering wheel control functions are completed.

NOTE: *Functions 1 ~ 12 must be assigned to a function on the OE steering wheel. For example, if the OE steering wheel does not support Preset + and Preset -, then these functions must be cleared / reset in order for the other functions to work correctly.*

3. To “learn” the programming completed in step 2 above, press the “Program” button. You will then be prompted to push each button on the OE steering wheel (for 1 second), so the unit can learn the corresponding function.
4. SWC learning / programming is now complete.



VX3010

JENSEN®

REAR CAMERA OPERATION

This unit is "camera ready." Before accessing any camera features, you must install a rear video camera (sold Separately).

When the camera is installed, the rear view image of what is behind the vehicle will appear when the vehicle is placed in reverse gear. When leaving reverse gear, the unit displays the previous screen.



Troubleshooting

Problem	Cause	Corrective action
General		
Unit can not power on	Unit fuse blown.	Install new fuse with correct rating.
	Car battery fuse blown.	Install new fuse with correct rating.
	Illegal operation	Reset the unit.
Remote control does not work	Battery depleted.	Change the battery.
	Battery installed incorrectly.	Install the battery correctly.
No/low audio output	Improper audio output connection.	Check wiring and correct.
	Volume set too low.	Increase volume level.
	Speakers damaged.	Replace speakers.
	Heavily biased volume balance.	Adjust the channel balance to center position.
	Speaker wiring is in contact with metal part of car.	Insulate all speaker wiring connections.
Poor sound quality or distortion	Pirate disc is in use.	Use original disc.
	Speaker power rating does not match unit.	Replace speakers.
	Wrong connections.	Check wiring and correct.
	Speaker is shorted.	Check wiring and correct.
Unit resets itself when engine is off	Incorrect connection between ACC and BATT.	Check wiring and correct.
TFT monitor		
Warning information is shown at all times	Parking brake wiring is not correct.	Check wiring and correct.
Flashing image or interference appears on screen	Pirate disc is in use.	Use original disc.
	Video cable damaged.	Replace cables.
	Improper video signal connections.	Check wiring and correct.

Troubleshooting (Continued)

Problem	Cause	Corrective action
Disc playback		
Cannot insert disc	A disc is inside the unit already.	Eject current disc and insert new one.
Disc does not play back	Disc is warped or scratched.	Use disc in good condition.
	Disc is dirty or wet.	Clean disc with soft cloth.
	Incompatible disc is used.	Use compatible disc.
	Disc is inserted upside down.	Insert disc with label side up.
	Disc region code is not compatible with unit.	Use disc with proper region code.
PBC cannot be used during VCD playback	PBC is not available on the disc.	Use disc with PBC available.
Repeat or search function is invalid during VCD playback	PBC is on.	Turn PBC off.
Error messages		
No disc	Disc is dirty.	Clean disc with soft cloth.
	Disc is upside down.	Insert disc with label side up.
	No disc inside.	Insert disc.
Bad disc	Disc is dirty.	Clean disc with soft cloth.
	Disc is upside down.	Insert disc with label side up.
Unknown disc	Disc format is not compatible with this unit.	Use disc with compatible format.
Region Error	DVD region code is not compatible with this unit.	Use disc with compatible region code.

SPECIFICATIONS

DVD/CD Player

Compatible Disc Media: DVD + R / RW (Single and Dual Layer) and CD-R / RW
Compatible Media Formats: CD-DA, MP3, WMA, VCD, SVCD, Xvid, AVI, MPEG 1/2
Signal to Noise Ratio: >95dBA
Dynamic Range: >95dB
Frequency Response: 20Hz to 20 kHz, -3dB
Channel Separation: > 60dB @ 1 kHz
D/A Converter: High performance 24-bit / 192 kHz sample rate, Multi-Bit Sigma-Delta Modulator

Video

Format: NTSC, PAL (auto-detection)
Output: 1Vp-p (75-ohm)
Input: 1Vp-p (75-ohm)

FM Tuner

Tuning Range: 87.5MHz - 107.9MHz
Mono Sensitivity (-30dB): 9dBf
Quieting Sensitivity (-50dB): 15dBf
Alternate Channel Selectivity: 70dB
Signal to Noise Ratio @ 1 kHz: 58dB
Image Rejection: 80dB Stereo Separation @ 1 kHz: >30dB
Frequency Response: 30Hz - 15 kHz, -3d

AM Tuner

Tuning Range: 530 kHz - 1720 kHz
Sensitivity (-20dB): 15uV
Signal to Noise Ratio @ 1 kHz: 50dB
Image Rejection: 60dB
Frequency Response: 50Hz - 2 kHz, -3dB

Monitor

Screen Size: 7.0" (Measured diagonally), 16:9 Widescreen
Screen Type: TFT Liquid Crystal Display (LCD) active matrix
Resolution: 1,152,000 pixels, 800W (x3) X 480H WVGA

VX3010

JENSEN®

General

Auxiliary Input impedance: 10k

Power Supply: 11 to 16VDC, negative ground

Power Antenna (Blue): 500mA max, current limited protection

Amplifier Remote (Blue/White): 500mA max, current limited protection

Operating Temperature: -20C ~ 65C

Fuse: 15-amp, mini ATM type

DIN chassis dimensions: 7" X 7" X 2" (178mm x 178mm x 50mm)

CEA Power Ratings



Power Output: 13 Watts RMS x 4 channels into 4-Ohms @ < 1% THD+N

Signal to Noise Ratio: 70dBA below reference (Reference: 1 Watt, 4-Ohms)

Frequency Response: 20 Hz - 20 kHz, -3dB. (Aux Input used as reference input)

Reference Supply Voltage: 14.4VDC

*Specifications subject to change without notice.

Care and Maintenance

1. Use only a clean silicone cloth and neutral detergent to clean the front panel or monitor. A rough cloth and non-neutral detergent (such as alcohol) may result in scratching or discoloration.
2. Do not get water or cleaning fluids on the unit.
3. If the temperature inside the player gets too hot, a protective circuit automatically stops play of the disc. If this occurs, allow the unit to cool before operating the player again.
4. Never insert anything other than a 12 cm (5") compact disc into the player as the mechanism can be damaged by foreign objects.
5. Do not attempt to use a 8 cm (3") CD-Single disc in this unit, either with or without an adaptor, as damage to the player and/or disc may occur. Such damage is not covered by the Warranty on this product.
6. The CD player may not operate properly in extreme hot or cold. If such conditions occur, allow the interior of the vehicle to reach a normal temperature before using player.
7. When the vehicle warms up during cold weather or under damp conditions, condensation may appear on the LCD panel. Should this occur, the screen will not operate properly until the moisture has evaporated.
8. We suggest you use a cleaning disc in this unit more frequently than in the unit in your home due to the environmental conditions of the vehicle.



VX3010

JENSEN®

NOTES:



Voxx Electronics Corporation
Hauppauge, NY 11788
Technical Assistance: 1-800-323-4815
www.jensenmobile.com
© 2013
Printed in China

VX3010 Common Replacement Parts

Owner's Manual, Install Manual and Warranty Card	30613960
Wire Harness (Pwr/Spk/Line Out/ BT Mic / SWC Adapter)	30313990
Trim Ring	30413940
Remote Control	30713990
Hardware Bag	30513940
Mounting Sleeve & Removal Keys	30113940

