



It is important to read this user manual prior to using your new product for the first time.

# Important safety instructions

## IMPORTANT SAFETY INSTRUCTIONS

PLEASE READ AND SAVE FOR FUTURE REFERENCE

 <p>THE LIGHTNING FLASH AND ARROWHEAD WITHIN THE TRIANGLE IS A WARNING SIGN ALERTING YOU OF "DANGEROUS VOLTAGE" INSIDE THE PRODUCT.</p>	<b>CAUTION</b> RISK OF ELECTRIC SHOCK DO NOT OPEN  CAUTION: TO REDUCE THE RISK OF ELECTRIC SHOCK, DO NOT REMOVE COVER (OR BACK). NO USER-SERVICEABLE PARTS INSIDE. REFER SERVICING TO QUALIFIED SERVICE PERSONNEL.	 <p>THE EXCLAMATION POINT WITHIN THE TRIANGLE IS A WARNING SIGN ALERTING YOU OF IMPORTANT INSTRUCTIONS ACCOMPANYING THE PRODUCT.</p>
SEE MARKING ON BOTTOM / BACK OF PRODUCT		

**WARNING:** TO PREVENT FIRE OR ELECTRICAL SHOCK HAZARD, DO NOT EXPOSE THIS PRODUCT TO RAIN OR MOISTURE.

Some of the following information may not apply to your particular product; however, as with any electronic product, precautions should be observed during handling and use.

- Read these instructions.
- Keep these instructions.
- Heed all warnings.
- Follow all instructions.
- Do not use this apparatus near water.
- Clean only with dry cloth.
- Do not install near any heat sources such as radiators, heat registers, stoves, or other apparatus (including amplifiers) that produce heat.
- Refer all servicing to qualified service personnel. Servicing is required when the apparatus has been damaged in any way, such as power-supply cord or plug is damaged, liquid has been spilled or objects have fallen into the apparatus, the apparatus has been exposed to rain or moisture, does not operate normally, or has been dropped.

### ADDITIONAL SAFETY INFORMATION

- Apparatus shall not be exposed to dripping or splashing and no objects filled with liquids, such as vases, shall be placed on the apparatus.
- Do not attempt to disassemble the cabinet. This product does not contain customer serviceable components.
- The marking information is located at the bottom of apparatus.

## Important battery precautions

- Any battery may present a risk of fire, explosion, or chemical burn if abused. Do not try to charge a battery that is not intended to be recharged, do not incinerate, and do not puncture.
- Non-rechargeable batteries, such as alkaline batteries, may leak if left in your product for a long period of time. Remove the batteries from the product if you are not going to use it for a month or more.
- If your product uses more than one battery, do not mix types and make sure they are inserted correctly. Mixing types or inserting incorrectly may cause them to leak.
- Discard any leaky or deformed battery immediately. They may cause skin burns or other personal injury.
- Please help to protect the environment by recycling or disposing of batteries according to federal, state, and local regulations.

**WARNING:** The battery (battery or batteries or battery pack) shall not be exposed to excessive heat such as sunshine, fire or the like.

## Ecology

Help protect the environment - we recommend that you dispose of used batteries by putting them into specially designed receptacles.

## Precautions for the unit

- Do not use the unit immediately after transportation from a cold place to a warm place; condensation problems may result.
- Do not store the unit near fire, places with high temperature or in direct sunlight. Exposure to direct sunlight or extreme heat (such as inside a parked car) may cause damage or malfunction.
- Clean the unit with a soft cloth or a damp chamois leather. Never use solvents.
- The unit must only be opened by qualified personnel.

## Headset safety

To use a headset safely, please keep the following in mind:

- Do not play your headset at a high volume. Hearing experts advise against continuous extended play.
- If you experience ringing in your ears, turn down the volume or stop using the headset.
- Do not use a headset while driving a motorized vehicle or riding a bike. It may cause a traffic hazard and is illegal in many areas.
- Even if your headset is an open-air type designed to let you hear outside sounds, don't turn up the volume so high that can't hear sounds around you.

# FCC Information

## FCC Information

Note: This equipment has been tested and found to comply with the limits for a Class B digital device, pursuant to Part 15 of FCC Rules. These limits are designed to provide reasonable protection against harmful interference in a residential installation. This equipment generates, uses, and can radiate radio frequency energy and, if not installed and used in accordance with the instructions, may cause harmful interference to radio communications.

However, there is no guarantee that interference will not occur in a particular installation. If this equipment does cause harmful interference to radio or television reception, which can be determined by turning the equipment off and on, the user is encouraged to try to correct the interference by one or more of the following measures:

- Reorient or relocate the receiving antenna.
- Increase the separation between the equipment and receiver.
- Connect the equipment into an outlet on a circuit different from that to which the receiver is connected.
- Consult the dealer or an experienced radio/TV technician for help.

Changes or modifications not expressly approved by Audiovox could void the user's authority to operate the equipment.

This device complies with Part 15 of the FCC Rules. Operation is subject to the following two conditions: (1) this device may not cause harmful interference, and (2) this device must accept any interference received, including interference that may cause undesired operation.

Manufacturer/Responsible Party  
Audiovox Accessories Corporation  
111 Congressional Blvd., Suite 350  
Carmel, IN 46032

1-317-810-4880 ( No technical /product support is available via this number. This phone number is for regulatory matters only.)

**Visit [www.rcaudiovideo.com](http://www.rcaudiovideo.com) for technical support**



RCA  
VR5340

This Class B digital apparatus complies with Canadian ICES-003.  
Cet appareil numérique de la classe B est conforme à la norme NMB-003 du Canada.

# Contents

## **Important safety instructions**

IMPORTANT SAFETY INSTRUCTIONS .....	1
Important battery precautions .....	2
Ecology.....	2
Precautions for the unit .....	2
Headset safety .....	2

<b>FCC Information.....</b>	<b>3</b>
-----------------------------	----------

<b>Contents .....</b>	<b>4</b>
-----------------------	----------

<b>End user license agreement .....</b>	<b>6</b>
---	----------

## **Before you begin**

Unpacking your player .....	9
Installing batteries .....	9
Using earphones and external microphone .....	9
Turning player on/off.....	9
Locking the player controls.....	9

## **Connecting to computer**

Computer system requirements.....	10
Connecting to computer.....	10

## **Installing Digital Voice Manager application**

Installing Digital Voice Manager.....	11
---------------------------------------	----

## **General controls**

Player controls.....	12
----------------------	----

## **Setting date and time**

To set the date and time.....	13
-------------------------------	----

## **Basic operations**

Selecting folders and files.....	14
Basic playback .....	14
Accessing information.....	14

## **Recording**

Setting recording mode .....	15
Setting recording quality .....	16
Setting recording mode .....	16

**Deleting files..... 17**

**Bookmarks**

To create bookmarks.....17

To delete bookmarks .....17

**Editing**

Selecting an edit function.....18

Append .....18

Cut.....18

**Formating**

To format the memory of the player:.....19

**Settings**

Accessing Settings menu .....19

**Troubleshooting tips**

**Warranty information**

12 Month Limited Warranty .....21

# End user license agreement

This is a copy of the EULA that you need to agree to in order to use this product.



## AUDIOVOX CORPORATION END USER LICENSE AGREEMENT

**IMPORTANT:** READ CAREFULLY BEFORE DOWNLOADING OR INSTALLING THIS SOFTWARE!

THIS END USER LICENSE AGREEMENT (THIS "EULA") IS A LEGAL AGREEMENT BETWEEN YOU AND AUDIOVOX CORPORATION AND, AS APPLICABLE, ANY AUDIOVOX SUBSIDIARY, AS DEFINED BELOW (COLLECTIVELY "AUDIOVOX"), FOR THE RCA BRANDED PORTABLE DIGITAL AUDIO/VIDEO DEVICE APPLICATION/DRIVER SOFTWARE PROGRAM WHICH MAY INCLUDE ASSOCIATED SOFTWARE COMPONENTS, SOFTWARE LICENSED BY AUDIOVOX FROM THIRD PARTIES ("LICENSORS") AND ASSOCIATED DOCUMENTATION, IF ANY (COLLECTIVELY, THE "PROGRAM"). THIS EULA CONTAINS IMPORTANT LEGAL LIMITATIONS, RESTRICTIONS AND DISCLAIMERS, AND ALSO SPECIFIES THE DURATION OF YOUR LICENSE.

BY INSTALLING THE PROGRAM OR CLICKING ON THE ACCEPTANCE BUTTON OF THE PROGRAM, COPYING OR OTHERWISE USING THE PROGRAM, YOU ACKNOWLEDGE AND AGREE THAT YOU HAVE READ THIS EULA, UNDERSTAND IT, AND AGREE TO BE BOUND BY ITS TERMS AND CONDITIONS. THIS PROGRAM IS PROTECTED BY COPYRIGHT LAWS AND INTERNATIONAL COPYRIGHT TREATIES, AS WELL AS OTHER INTELLECTUAL PROPERTY LAWS AND TREATIES. YOU MAY USE THE PROGRAM ONLY IN ACCORDANCE WITH THIS EULA, AND ANY SUCH USE IS HEREBY UNDERSTOOD TO BE CONDITIONAL UPON YOUR SPECIFIC AGREEMENT TO THE UNMODIFIED TERMS SET FORTH HEREIN. IF YOU DO NOT AGREE WITH ALL OF THE TERMS OF THIS EULA, CLICK ON THE REJECTION BUTTON AND/OR DO NOT INSTALL THE PROGRAM AND/OR DO NOT USE THE PROGRAM.

### 1. LICENSE

- (a) Under this EULA, you are granted a non-exclusive, non-sublicenseable, non-assignable and non-transferable (except as expressly set forth below) license (i) to use and install the Program on a single workstation, and (ii) to make one (1) copy of the Program into any machine-readable form for backup of the Program, provided the copy contains all of the original Program's proprietary notices.
- (b) You may transfer the Program and license to another party only as a part of the RCA branded Portable Digital Audio/Video Device ("A/V Device"), and only if the other party agrees to accept the terms and conditions of this EULA. If you transfer the Program, you must at the same time either transfer all copies to the same party or destroy any copies not transferred.
- (c) The terms of this EULA will govern any software upgrades or updates provided by AUDIOVOX that replace and/or supplement the original Program, unless such upgrade or update is accompanied by separate license terms and conditions in which case the terms of that separate license will govern. You acknowledge and agree that AUDIOVOX may automatically download upgrades or updates to the Program software to your computer in order to update, enhance, and/or further develop the Program.

### 2. LICENSE RESTRICTIONS

- (a) Except for the licenses expressly granted to you in this EULA, no other licenses or rights are granted or implied.
- (b) You may not (i) make the Program available over a network where it could be used by multiple computers at the same time; (ii) modify, translate, reverse engineer, decompile, disassemble (except to the extent that this restriction is expressly prohibited by law), or create derivative works based upon the Program; (iii) copy the Program, except as expressly permitted herein; (iv) remove or alter any copyright notices on all copies of the Program; or (v) rent, lease or lend the Program. You agree that you shall only use the Program in a manner that complies with all applicable laws in the jurisdictions in which you use the Program, including, but not limited to, applicable restrictions concerning copyright and other intellectual property rights.

(c) The Program may contain pre-release code that does not perform at the level of a final code release. In such case, the Program may not operate properly. Updated versions of the Program may be downloaded from [www.rcaaudiovideo.com/downloads](http://www.rcaaudiovideo.com/downloads)

(d) AUDIOVOX is not obligated to provide support services for the Program.

(e) The Program is provided with "RESTRICTED RIGHTS". Use, duplication, or disclosure by the U.S. Government is subject to restrictions as set forth in subparagraph (c)(1)(ii) of DFARS 252.227-7013, or FAR 52.227-19, or in FAR 52.227-14 Alt. III, as applicable.

### 3. TERM AND TERMINATION

(a) Your license is effective on the date you accept this EULA and remains in effect until this EULA is terminated by either party.

(b) You may terminate this EULA and the associated license, without any notice or delay, by destroying or permanently erasing the Program and all copies thereof.

(c) If you fail to comply with any of the terms of this EULA, in whole or part, your license will automatically terminate without notice from AUDIOVOX.

(d) Upon termination of this EULA and your associated license, you shall cease all use of the Program and destroy or permanently erase the Program and all full or partial copies thereof.

### 4. WARRANTY DISCLAIMER

THE PROGRAM IS PROVIDED "AS IS" WITHOUT WARRANTY OF ANY KIND, EITHER EXPRESSED OR IMPLIED, INCLUDING, BUT NOT LIMITED TO THE IMPLIED WARRANTIES OF MERCHANTABILITY, FITNESS FOR A PARTICULAR PURPOSE, TITLE OR NON-INFRINGEMENT. THE ENTIRE RISK AS TO THE QUALITY AND PERFORMANCE OF THE PROGRAM IS WITH YOU. SHOULD THE PROGRAM PROVE DEFECTIVE, YOU (AND NOT AUDIOVOX, ITS SUPPLIERS, OR ITS DEALERS) ASSUME THE ENTIRE COST FOR ALL NECESSARY REPAIR OR CORRECTION.

This exclusion of warranty may not be allowed under some applicable laws. As a result, the above exclusion may not apply to you, and you may have other rights depending on the law that applies to you.

### 5. OWNERSHIP RIGHTS

All title and intellectual property rights, including but not limited to copyrights, in and to the Program and any copies thereof are owned by AUDIOVOX, its Licensors or its suppliers. All title and intellectual property rights in and to the content which may be accessed through use of the Program is the property of the respective content owner and may be protected by applicable copyright or other intellectual property laws and treaties. This license grants you no rights to use such content. All rights not expressly granted are reserved by AUDIOVOX or its Licensors.

### 6. LIMITATION OF LIABILITY

(a) TO THE MAXIMUM EXTENT PERMITTED BY APPLICABLE LAW, IN NO EVENT SHALL AUDIOVOX, OR ITS DEALERS BE LIABLE FOR ANY SPECIAL, INCIDENTAL, INDIRECT, OR CONSEQUENTIAL DAMAGES WHATSOEVER (INCLUDING, WITHOUT LIMITATION, DAMAGES FOR LOSS OF PROFITS, BUSINESS INTERRUPTION, CORRUPTION OF FILES, LOSS OF BUSINESS INFORMATION, OR ANY OTHER PECUNIARY LOSS) REGARDLESS OF CAUSE OR FORM OF ACTION, INCLUDING CONTRACT, TORT, OR NEGLIGENCE, ARISING OUT OF YOUR USE OF OR INABILITY TO USE THE PROGRAM, EVEN IF AUDIOVOX HAS BEEN ADVISED OF THE POSSIBILITY OF SUCH DAMAGES. BECAUSE SOME STATES AND JURISDICTIONS DO NOT ALLOW THE EXCLUSION OR LIMITATION OF LIABILITY OF CONSEQUENTIAL OR INCIDENTAL DAMAGES, THE ABOVE LIMITATION MAY NOT APPLY TO YOU.

(b) YOU ASSUME RESPONSIBILITY FOR THE SELECTION OF THE APPROPRIATE PROGRAM TO ACHIEVE YOUR INTENDED RESULTS, AND FOR THE INSTALLATION, USE, AND RESULTS OBTAINED.



## 7. THIRD PARTY SOFTWARE

ANY THIRD PARTY SOFTWARE THAT MAY BE PROVIDED WITH THE PROGRAM IS INCLUDED FOR USE AT YOUR OPTION. IF YOU CHOOSE TO USE SUCH THIRD PARTY SOFTWARE, THEN SUCH USE SHALL BE GOVERNED BY SUCH THIRD PARTY'S LICENSE AGREEMENT, AN ELECTRONIC COPY OF WHICH WILL BE INSTALLED IN THE APPROPRIATE FOLDER ON YOUR COMPUTER UPON INSTALLATION OF THE SOFTWARE. AUDIOVOX IS NOT RESPONSIBLE FOR ANY THIRD PARTY'S SOFTWARE AND SHALL HAVE NO LIABILITY FOR YOUR USE OF THIRD PARTY SOFTWARE.

## 8. GOVERNING LAW

If you acquired this A/V Device in the United States, this EULA shall be governed and construed in accordance with the laws of the State of Indiana, U.S.A. without regard to its conflict of laws principles. If you acquired this A/V Device outside the United States or the European Union, then local law may apply.

## 9. GENERAL TERMS

This EULA can only be modified by a written agreement signed by you and AUDIOVOX, and changes from the terms and conditions of this EULA made in any other manner will be of no effect. If any portion of this EULA shall be held invalid, illegal, or unenforceable, the validity, legality, and enforceability of the remainder of the Agreement shall not in any way be affected or impaired thereby. This EULA is the complete and exclusive statement of the agreement between you and AUDIOVOX, which supersedes all proposals or prior agreements, oral or written, and all other communications between you and AUDIOVOX, relating to the subject matter of this hereof. AUDIOVOX'S Licensors shall be considered third party beneficiaries of this Agreement and shall have the right to enforce the terms herein.

"AUDIOVOX SUBSIDIARY" shall mean any person, corporation, or other organization, domestic or foreign, including but not limited to subsidiaries, that is directly or indirectly controlled by Audiovox Corporation including, but not limited to, Audiovox Consumer Electronics, Inc. and Audiovox Electronics Corporation. For purposes of this definition only, the term "control" means the possession of the power to direct or cause the direction of the management and policies of an entity, whether by ownership of voting stock or partnership interest, by contract, or otherwise, including direct or indirect ownership of at least fifty percent (50%) of the voting interest in the entity in question.

## 10. CONSENT TO USE OF DATA

You agree that Audiovox and its subsidiaries may collect and use technical and related information that does not personally identify you, including but not limited to offers opted into by you with Audiovox partners, technical information about your computer, system and application software, IP address and peripherals, that is gathered periodically to facilitate the provision of software updates, product support and other services to you (if any) related to the RCA Software and to verify compliance with the terms of this License. Audiovox may use this information, as long as it is in a form that does not personally identify you, to improve our products or to provide services or technologies to you.

## Before you begin

### Unpacking your player

You should have the following:

- RCA voice recorder
- USB cable
- Two "AAA" batteries
- Quick start guide

### Installing batteries

1. Apply thumb pressure to slide the battery compartment cover in the direction of the arrow, then remove the cover.

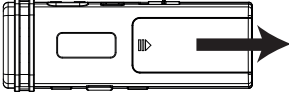

2. Insert two "AAA" batteries (included), following the polarity marks in the battery compartment.
  3. Reinstall the cover.
- Refer to the battery level indicator  on display for battery's level. Replace with new batteries when the indicator is flashing.

### Using earphones and external microphone

- When earphones are connected, sound output from speaker will be muted.
- When external microphone is connected, no recording can be made from built-in microphone.

### Turning player on/off

Slide  switch to .

### Locking the player controls

To avoid accidental key activation, slide  /  towards  to lock the keys. Reverse the step to unlock.

Turn off the player first before replacing batteries. If power interruption exceeds 20 seconds, date and time have to be set again.



## Connecting to computer

### Computer system requirements

#### **Windows: Windows XP (SP2 or higher) or Windows Vista or Windows 7**

- Pentium 4 1.6GHz or equivalent AMD Athlon processor
- 512 MB RAM (1GB recommended)
- 300 MB available hard disk space
- 1024 x 768 pixels, 16-bit color monitor or higher
- Internet Access (broadband recommended)

#### **Macintosh: OS X 10.5 or 10.6**

- Intel Core Duo processor (or higher)
- 768 MB RAM (1GB recommended)
- 300 MB available hard disk space
- 1024 x 768 pixels or higher recommended
- Internet Access (broadband recommended)

### Connecting to computer

Connect the player before launching the Digital Voice Manager.

1. Connect the player and PC with USB cable (included).
2. **Connected** shows on the player's display. The player appears as a removable drive in your computer.

# Installing Digital Voice Manager application

## Installing Digital Voice Manager

1. Connect the player with the computer as instructed in the previous section.
2. **Windows:** To access the RCA Digital Voice Manager installer, go to **My Computer** (XP users) /Go to **Computer** (Vista and 7 users) in the Start menu, find and open the drive letter associated with the player and then double-click the **rcadv7\_setup.exe** to launch the installer.

**Mac:** To access the RCA Digital Voice Manager installer, the player will mount as a volume on the desktop. Double-click the volume associated with the player and you will be initially seeing the RCA Digital Voice Manager Installer.dmg. When you double-click on this file, it will mount as a volume on the desktop. Double-click the "RCA Digital Voice Manager Installer" icon in the popup window to start the installation.

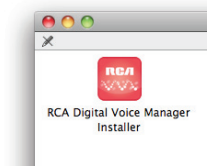

3. Follow the on-screen instructions to complete the installation. The RCA Detective application is installed with the Digital Voice Manager application and will open the Digital Voice Manager application automatically when you connect the player to your computer.

For information on the RCA Digital Voice Manager and how it works with this unit, refer to the Help Section of the software.

- When the player is in player menu mode, during playback mode or recording mode, a connection between the player and the computer will not be established. Quit the above modes before connecting to the computer.
- Data transfer is possible even if no batteries are installed in the player.
- Do not disconnect the USB connection during files transfer.
- The latest Digital Voice Manager software can be downloaded from [www.rcaaudiovideo.com](http://www.rcaaudiovideo.com).



# General controls

## Player controls

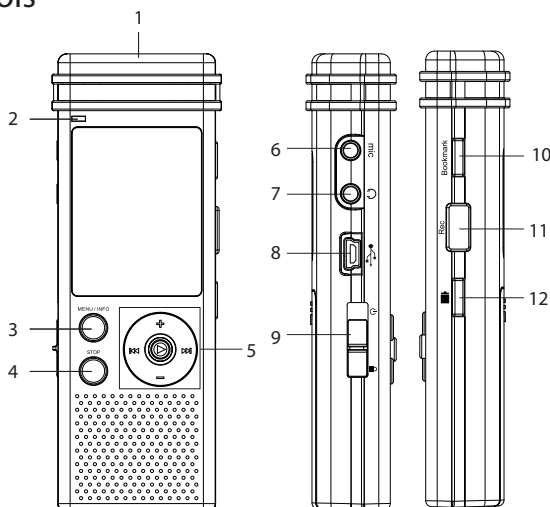

1. Built-in microphone
2. Recording indicator
3. **MENU/INFO** – While playback is stopped, **press and hold** to access the player menu. While playback is stopped, **simply press** to display playtime, record time, record date and remain record time.
4. **STOP** – Stops recording or playback; quit the sub menu and go to main menu; quit the main menu and go to STOP mode.
5. – To confirm a setting in menu. To start playback or pause the playback.  
+ / – Adjust the volume level; move up/down in the menu; change playback speed in PAUSE mode.  
 / – Skip to previous/next track or bookmark if bookmarks have been set; move left or right in the menu; press and hold to fast backward or forward.
6. External microphone jack
7. External earphones jack
8. USB connector – To connect the player and PC with a USB cable (included).
9. / – Power on/off; lock/unlock player controls
10. **Bookmark** – Inserts bookmarks or enter the bookmark delete menu.
11. **Rec** – Starts and pauses recording
12. – Erases files or cut the unwanted parts from a file.

## Setting date and time

With day and time set, you can always read on the display the recording date and time of your recorded messages. Normal recording is still possible without setting. However, no correct recording date and time can be referenced in your recorded messages.

### To set the date and time

1. While playback is stopped, press and hold **MENU/INFO** to access the player menu.
2. Press **◀▶** to select **Date&Time** and press **▶** to confirm.
3. Press **+ / -** to select Set Time, Set Date and Time Format and press **▶** to confirm.
4. Press **◀▶** to select hour, minute, AM/PM, month, day and year. Press **+ / -** to adjust the value and then press **▶** to confirm.

If 24hr mode is selected, date format will be changed from MM/DD/YY to DD/MM/YY.



## Basic operations

### Selecting folders and files

1. While playback is stopped, press and hold **MENU/INFO** to access the player menu.
2. Press **⏮/⏭** to select **Folders** and press **▷** to confirm.
3. Press **+ / -** to select folder and press **▷** to confirm.
4. Press **+ / -** to select files and press **▷** to confirm. Press **⏮/⏭** to skip to the previous/next folders.

- If the file you want is in the current folder, you can press **⏮/⏭** to select it directly while in either the Stop or Play modes.
- If the file is not supported by the unit, **This file cannot be supported!** will be shown.



### Basic playback

#### To play back recorded files:

1. Select a folder and a file.
2. Press **▷** to start playback.
3. Press **▷** to pause playback, press again to resume.
4. You can press **+ / -** to adjust volume.
5. When playback is paused, press **+ / -** to select different speeds to make quick search within a file. Options are SLOW, NORM(Normal) and FAST. You can also select the playback speed by adjusting the value of Play Speed in Settings menu. Refer to Settings section for details.
6. Select playback mode (Repeat One, Repeat All) by selecting the desired mode in the Settings menu. Refer to Settings section for details.
7. Press **⏮** or **⏭** once to skip to the previous/next file. Press and hold **⏮** or **⏭** to fast backward/forward through the file.
8. Press **STOP** to stop playback.

- The screen will be turned off automatically after one minute of elapsed playback time. Press any buttons to turn on the screen.
- The unit will enter Stop mode if playback is paused for more than 30 minutes.



### Accessing information

While playback is stopped, press **MENU/INFO** to switch among different information.

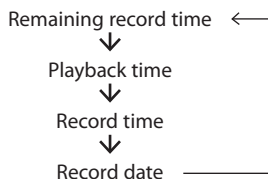

# Recording

## Setting recording mode

### Manual Recording

1. While playback is stopped, press **Rec** to start recording. Recording time will be displayed once you press the button.
2. To pause recording, press **Rec** once, press again to resume recording.
3. To stop recording, press **STOP**.

### AVR (Automatic Voice Recording)

This feature allows the player to sense sound and to record only when you are speaking into the microphone. When dictation stops for about three seconds, recording will pause and then start again automatically when you resume dictation.

1. Select **AVR On** in Settings menu. (Refer to Settings section)
2. Press **Rec** to enter AVR mode.
3. Start dictation. Recording starts automatically.
4. Press **STOP** to end AVR recording.

To adjust the sensitivity (Low/Middle/High) of the microphone, press +/- during AVR recording.

- The unit will enter Stop mode if recording is paused for more than 30 minutes.
- AVR works better for dictation applications than lecture or conference recordings as background noise can cause some false triggers.
- During recording, the recording indicator stays on. When in AVR standby mode or when recording is paused, the recording indicator and the recording icon on the display flash.
- The first syllable or two may be lost when you start recording because this 'sound' is used to turn on the AVR feature. It is a good practice to make some 'sounds' or say a short word to activate the AVR before you begin actual dictation.
- You can record up to 200 files in one folder. When the maximum limit is reached, **MAXIMUM FILES REACHED IN SELECTED FOLDER** will be shown.
- When the maximum limit of the player's internal memory is reached, **MEMORY FULL** will be shown.
- The remain recording time is shown on the display in STOP mode.
- The screen will be turned off automatically after one minute of elapsed record time. Press any button to turn on the screen.





## Setting recording quality

Definition:

- **LP (Long Play)** – allows about 800 hours recording. Recording format: .voc
- **SP (Standard Play)** – allows about 140 hours recording. Recording format: .voc
- **HQ (High Quality)** – allows about 70 hours recording. Recording format: .wav

Refer to Settings section for instructions on how to select recording quality.

## Setting recording mode

Definition:

- **CONF (Conference)** – Use in a more open area where recording source is far from the player.
- **DICT (Dictation)** – Use in a more enclosed area where recording source is close to the player.

Refer to Settings section for instructions on how to select recording mode.

- For conferences, to obtain optimum recording quality, place the recorder with the microphone freely exposed to the sound source as close as convenient. A built-in automatic recording level control will set the optimum record level during manual recording. Avoid recording near unwanted noise sources, such as air conditioners or fans.
- If power supplied from the battery fails suddenly (e.g. batteries are removed accidentally) during recording, the recording in progress will be interrupted. The recorded file may also be corrupted and cannot be played back.



## Deleting files

1. While playback is stopped, press **⏏**.
2. Press + / - to select one of the deleting options:
  - Delete the current file (**Current file name**)
  - Delete all files in the current folder (**ALL**) and press **▷** to select the desired option.
3. Press **▷** to confirm.

Press **STOP** to cancel deleting current file or all files.



## Bookmarks

### To create bookmarks

- Press **Bookmark** during playback.
- You can create up to 29 bookmarks in a file. When the maximum limit is reached, **NO MORE BOOKMARKS AVAILABLE** will be shown.

### To delete bookmarks

1. While playback is stopped, press and hold **Bookmarks**.
2. Press + / - to select a bookmark or select **ALL** (to delete all bookmarks created in the current file).
3. Press **▷** to confirm delete.

# Editing

## Selecting an edit function

1. While playback is stopped, press and hold **MENU/INFO** to access the player menu.
2. Press **◀◀/▶▶** to select **Edit** and press **▷** to confirm.
3. Press **+ / -** to select Insert, Append or Cut and press **▷** to confirm.
4. To disable the edit function, select Off and press **▷** to confirm.

If edit function has not been selected in Edit menu, **NO EDIT FUNCTION SELECTED. PLEASE SELECT EDIT MODE IN EDIT MENU** will be shown when **Rec** is pressed and held or **⏏** is pressed during playback.



## Insert

To insert a new segment into the current file:

1. Follow steps of "Selecting an edit function" above to select **Insert** in Settings menu.
2. During playback, press and hold **Rec** to start recording. The newly recorded segment will be inserted from this point.
3. Press **STOP** to stop the recording of new segment.

## Append

To insert an appendix at the end of the current file:

1. Follow steps of "Selecting an edit function" above to select **Append** in Settings menu.
2. During playback, press and hold **Rec** to start recording. The **REC** icon will be shown and the recording of appendix will be started.
3. Press **STOP** to stop the recording of the appendix.

## Cut

**To erase unwanted parts from the current file:**

1. Follow steps of "Selecting an edit function" above to select **Cut** in Settings menu.
2. During playback, press **⏏** to mark start location and begin cut mode.
3. Press **⏏** again to mark end location.
4. Press **⏏** again to confirm cutting the selected segment. If **⏏** is not pressed to confirm, the cutting operation will be cancelled.

- Insert, Append and Cut will only update the recorded time length, without changing recording time and date.
- All bookmarks will be deleted after Insert, Append or Cut is performed.



## Formating

### To format the memory of the player

1. Select Format in Settings menu. Refer to Settings section for details.
2. When Format is selected, **ALL DATA IN MEMORY WILL BE PERMANENTLY REMOVED** will be shown.
3. Press  $\triangleright$  to confirm your selection and start the formatting.

- Formatting the internal memory may be required when:
  1. The internal memory becomes unstable after multiple cycles of creating and deleting files.
  2. It is necessary to ensure the file system compatibility (i.e. the device memory requires FAT32 formatting for correct operation) .
- You may also format the player when connected to a PC by right-clicking on the player's drive name or letter and select "Format" from the menu. Make sure you select FAT or FAT32 as the file system.



## Settings

### Accessing Settings menu

1. While playback is stopped, press and hold **MENU/INFO** to access the player menu.
2. Press  $\lll / \ggg$  to select **Settings** and press  $\triangleright$  to confirm.
3. Press + / - to highlight the desired item. Then press  $\triangleright$  to select that item.
4. Press + / - or  $\lll / \ggg$  to adjust the value. Then press  $\triangleright$  to save the setting.
5. Press **STOP** repeatedly to revert to main screen.

Menu options	Available settings
Mode	Conf/Dict
Quality	LP/SP/HQ
AVR	On/Off
Playspeed	Slow/Norm/Fast
Play Mode	One/All
Beep Tone	On/Off
Format	Ask for confirmation
Version	Show the current firmware version

Detailed explanations for some of these settings are available in Basic Operation and Recording sections in the User Manual.



# Troubleshooting tips

## **Player doesn't turn on**

- Check that batteries are properly inserted and not exhausted.
- Make sure battery compartment door is properly closed.
- Make sure LOCK function is not activated.

## **Can not record**

- This player does not record mp3 format.
- Make sure LOCK function is not activated.
- Make sure memory is not full.
- You have recorded 200 files in one folder. Try to record in a new folder.
- You may have formatted the player with an incorrect file system (e.g. NTFS or MAC format). Refer to Settings section and format the player again.

## **Incorrect recording date and time during playback**

- You may have not set the date and time before recording. Refer to Setting date and time section.

## **No sound from speaker during playback**

- Make sure volume is not set to 0.
- Headphones should not be connected.

## **Can not activate the player after pressing on keys**

- Remove the batteries to reset the player.

## **Recordable time becomes shorter**

- You may have set the recording quality to 'High Quality', refer to Setting recording quality section.
- Delete the Digital Voice Manager setup software from the player to free up more memory space.

## **Can not perform playback**

- This player does not play mp3 format.
- Make sure you have selected a folder which contains recorded messages.
- Make sure LOCK function is not activated.
- Make sure the file is playable, which must be of 8-bit PCM or designated RCA format. Other formats (e.g. mp3, wma) can not be shown in the player for playback.

## **Can not delete recorded file(s)**

- Make sure you follow each step under Deleting Files section carefully.

## **Can not keep the saved settings**

- If the batteries are removed, saved settings may be removed.

## **Can not open recorded files in the computer.**

- Install and Use the Digital Voice Recorder software which is preloaded in your Voice Recorder. You may also download the software from [www.rcaaudiovideo.com](http://www.rcaaudiovideo.com).

## Warranty information

### 12 Month Limited Warranty Applies to RCA Voice Recorders

AUDIOVOX ACCESSORIES CORP. (the Company) warrants to the original retail purchaser of this product that should this product or any part thereof, under normal use and conditions, be proven defective in material or workmanship within 12 months from the date of original purchase, such defect(s) will be repaired or replaced with reconditioned product (at the Company's option) without charge for parts and repair labor.

To obtain repair or replacement within the terms of this Warranty, the product is to be delivered with proof of warranty coverage (e.g. dated bill of sale), specification of defect(s), transportation prepaid, to the Company at the address shown below.

This Warranty does not extend to the elimination of externally generated static or noise, to correction of antenna problems, loss/interruptions of broadcast or internet service, to costs incurred for installation, removal or reinstallation of product, to corruptions caused by computer viruses, spyware or other malware, to loss of media, files, data or content, or to damage to tapes, discs, removable memory devices or cards, speakers, accessories, computers, computer peripherals, other media players, home networks or vehicle electrical systems.

This Warranty does not apply to any product or part thereof which, in the opinion of the Company, has suffered or been damaged through alteration, improper installation, mishandling, misuse, neglect, accident, or by removal or defacement of the factory serial number/bar code label(s). THE EXTENT OF THE COMPANY'S LIABILITY UNDER THIS WARRANTY IS LIMITED TO THE REPAIR OR REPLACEMENT PROVIDED ABOVE AND, IN NO EVENT, SHALL THE COMPANY'S LIABILITY EXCEED THE PURCHASE PRICE PAID BY PURCHASER FOR THE PRODUCT.

This Warranty is in lieu of all other express warranties or liabilities. ANY IMPLIED WARRANTIES, INCLUDING ANY IMPLIED WARRANTY OF MERCHANTABILITY, SHALL BE LIMITED TO THE DURATION OF THIS WRITTEN WARRANTY. ANY ACTION FOR BREACH OF ANY WARRANTY HEREUNDER INCLUDING ANY IMPLIED WARRANTY OF MERCHANTABILITY MUST BE BROUGHT WITHIN A PERIOD OF 24 MONTHS FROM DATE OF ORIGINAL PURCHASE. IN NO CASE SHALL THE COMPANY BE LIABLE FOR ANY CONSEQUENTIAL OR INCIDENTAL DAMAGES FOR BREACH OF THIS OR ANY OTHER WARRANTY. No person or representative is authorized to assume for the Company any liability other than expressed herein in connection with the sale of this product.

Some states do not allow limitations on how long an implied warranty lasts or the exclusion or limitation of incidental or consequential damage so the above limitations or exclusions may not apply to you. This Warranty gives you specific legal rights and you may also have other rights which vary from state to state.

#### **Recommendations before returning your product for a warranty claim:**

- If your product is capable of storing content (such as an mp3 player, voice recorder, camcorder, digital photo frame, etc), it is recommended to make periodic backup copies of content stored on the product. If applicable, before shipping a product, make a back up copy of content or data stored on the device. Also, it is advisable to remove any personal content which you would not want exposed to others. IT IS LIKELY THAT CONTENTS AND DATA ON THE DEVICE WILL BE LOST DURING SERVICE AND REFORMATTING. AUDIOVOX ACCEPTS NO LIABILITY FOR LOST CONTENT OR DATA, OR FOR THE SECURITY OF ANY PERSONAL CONTENT OR DATA ON THE RETURNED DEVICE. Product will be returned with factory default settings, and without any pre-loaded content which may have been installed in the originally purchased products. Consumer will be responsible for reloading data and content. Consumer will be responsible to restore any personal preference settings.

- Properly pack your unit. Include any remotes, memory cards, cables, etc. which were originally provided with the product. However DO NOT return any removable batteries, even if batteries were included with the original purchase. We recommend using the original carton and packing materials. Ship to

**Audiovox Electronics Corp.**  
**Attn: Service Department.**  
**150 Marcus Blvd.**  
**Hauppauge N.Y. 11788**

1-800-645-4994

For Canada Customers, please ship to:

Audiovox Return Centre  
c/o Genco  
6685 Kennedy Road,  
Unit#3, Door 16,  
Mississauga, Ontario  
L5T 3A5

Illustrations contained within this publication are for representation only and subject to change.

The descriptions and characteristics given in this document are given as a general indication and not as a guarantee. In order to provide the highest quality product possible, we reserve the right to make any improvement or modification without prior notice.

Visit <http://store.audiovox.com> to find the best accessories for your products.



For Customer Service  
Visit Our Website At

[www.rcaudiovideo.com](http://www.rcaudiovideo.com)

Product Information, Photos,  
FAQ's, User Manual

© 2011 Audiovox Accessories Corporation  
111 Congressional Blvd., Suite 350  
Carmel, IN 46032  
Trademark(s) ® Registered

v1.0 (1.0.1.0)