



VM9725BT

Operating Instructions



160 watts peak
40W x 4



VM9725BT

Thank you for choosing a Jensen product. We hope you will find the instructions in this owner's manual clear and easy to follow. If you take a few minutes to look through it, you'll learn how to use all the features of your new Jensen VM9725BT Mobile Multimedia Receiver for maximum enjoyment.

CONTENTS

Features.....	3
Controls and Indicators.....	6
Remote Control.....	8
Operating Instructions.....	14
Steering Wheel Controls	22
Settings Menu.....	23
Tuner Operation	31
DVD/VCD Video Operation	37
DVD/CD Audio Operation	43
MP3/WMA Operation	47
iPod®/iPhone® Operation.....	53
Pandora Operation.....	57
Bluetooth Operation	61
SiriusXM® Radio Operation.....	70
Rear Camera Operation.....	81
Troubleshooting	82
Care and Maintenance	86
Specifications.....	87
Common Replacement Parts	89
Notes.....	90

VM9725BT



FEATURES

Congratulations on your purchase of the Jensen VM9725BT Mobile Multimedia Receiver. It's a good idea to read all of the instructions before beginning the installation. We recommend having your Jensen VM9725BT installed by a reputable installation shop.

DVD

- Fast Forward/Reverse - 2X, 4X, 8X, and 20X
- Slow Motion Forward/Reverse - 1/2, 1/4, 1/6, and 1/8
- Play, Pause, Stop, Next Chapter, and Previous Chapter

CD / MP3 / WMA

- CD-Text Compatible
- ID3 Tag Compatible
- Directory Search (MP3 / WMA Only)
- Burn up to 1500 MP3 and WMA Files onto a DVD+R / RW
- Audible Forward / Reverse Track Search (CD-DA Only)
- Random, Repeat and Intro
- Play, Pause, Stop, Next Track, and Previous Track

AM-FM

- USA / Europe / Latin America / Asia Frequency Spacing
- 30 Station Presets (18 FM / 12 AM)
- Auto Stereo / Mono
- Local / Distance
- Auto Store / Preview Scan

iPod®/iPhone®

- iPod®/ iPhone® via USB
- High Speed Direct Connect Interface to Access iPod® Playlists, Artists, Albums and Songs. Play music and view video/photo* files from your iPod®. *Video/photo playback requires jLink-USB iPod® interface cable (sold separately).
- Power Management Charges iPod® while Connected

SiriusXM® Ready

- Satellite Channel Name, Artist, Song, and Categories Displayed on Monitor



VM9725BT

Chassis

- 2.0 DIN (Import / ISO-DIN Mountable)
- Fixed Front Panel
- 6.2" High Definition TFT LCD
- 1,152,000 Sub Pixels (800 x 3 X 480)
- Beep Tone Confirmation (ON-OFF Option)
- Heat Management System - Forced-Air Cooling To Keep The Chip-Sets Operating at Nominal Temperatures

General

- Built-In Bluetooth® with external microphone, providing Hands-Free operation for safety and convenience and A2DP for streaming music from your smartphone or other Bluetooth® device.
- One Composite Video Output for Additional Screens
- Front Panel Audio/Video Input
- Three-Band Tone control (Bass, Mid and Treble) with Eight Preset EQ Curves
- Front Panel A/V Aux Input for Portable Media Devices
- Rear Subwoofer Line Output
- Programmable Volume Control
- Rear Camera Input (Normal and Mirror Image View)
- Touch Screen Calibration Mode
- 4VRMS Line Output - All Channels
- Rotary Encoder Audio Control
- Front / Rear / Sub Line Output
- Rear USB Input

Navigation

- TTS Voice Guidance – Street Names Announced
- English, French and Spanish TTS Voice
- Tele Atlas Map Data
- 11 Million Points of Interest
- 4GB SD Card with Continental US, Alaska, Hawaii, and Puerto Rico
- Latest Map Guarantee (Limited time only - Must be used within 90 days of initial activation)

Rear Camera

The VM9725BT is "camera ready." Before accessing any camera features, you must purchase and install a rear video camera. Once the camera is connected and operating properly, the CAMERA source mode will become active. While the camera is not installed, the CAMERA option appears gray, indicating the function is not available.

VM9725BT



WARNING! Never install this unit where operation and viewing could interfere with safe driving conditions.

WARNING! To reduce the risk of a traffic accident (except when using for rear view video camera) never use the video display function while driving the vehicle. This is a violation of federal law.

WARNING! Never disassemble or adjust the unit.

WARNING! To prevent injury from shock or fire, never expose this unit to moisture or water.

WARNING! Never use irregular discs.



VM9725BT

CONTROLS AND INDICATORS

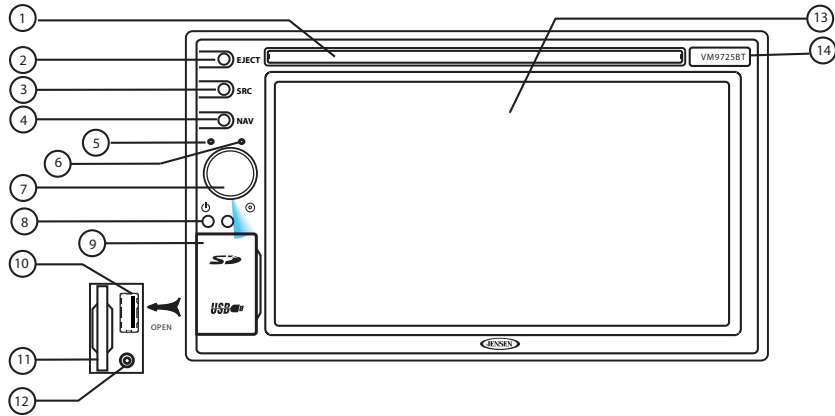

VM9725BT



1. **Disc Slot**
2. **EJECT Button**
Press to eject a disc.
3. **SRC Button**
Press to switch between the available audio/video sources applied to the unit.
4. **NAV Button**
Press to toggle back and forth between the navigation and currently selected source.
5. **Internal Microphone**
Internal microphone for Bluetooth calls.
6. **Reset Button**
Press to reset system settings to factory default (except password and parental lock settings).
7. **Rotary Encoder / Power On/Off (⏻) Button**
Rotate to adjust the volume. Press momentarily to activate the MUTE function. Press again to resume normal listening.
Press to turn the unit ON. Press and hold to turn the unit OFF.
8. **Remote Sensor**
9. **USB/SD/AV Interface Connector Cover**
10. **USB Interface Connector**
Connect a USB device for playback of music/video files.
11. **SD Interface Connector**
Insert an SD card for playback of music/video files.
12. **A/V Input**
Accepts a 3.5 mm jack through which signals from various audio/video devices can be applied to the unit.
13. **TFT Display**
14. **Map Cover**
Covers the Mini SD card slot. The Mini SD card is used for the Navigation Map only, not for music or other files. This may be used for firmware updates if required.



VM9725BT

REMOTE CONTROL

See Table 1 for remote control functions.

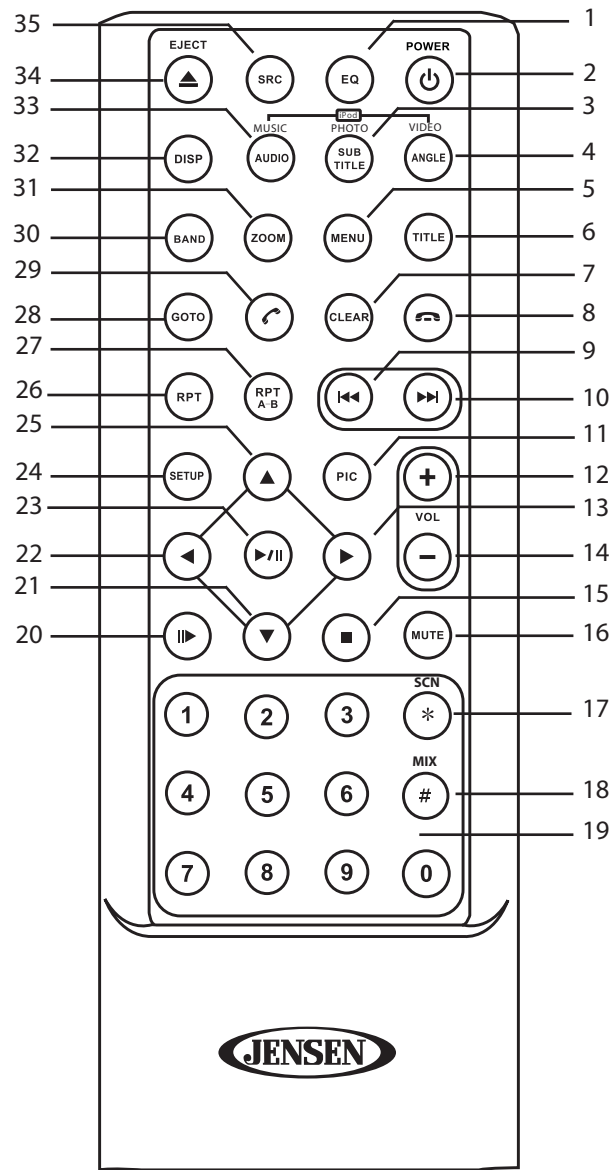



Table 1: Remote Control Functions

Button Name	Function					
	#	DVD	VCD	TUNER	CD/MP3/USB	iPod
EQ	1	Accesses equalizer menu.	Accesses equalizer menu.	Accesses equalizer menu.	Accesses equalizer menu.	Accesses equalizer menu.
POWER (⏻)	2	Turns the power on/off.	Turns the power on/off.	Turns the power on/off.	Turns the power on/off.	Turns the power on/off.
PHOTO/SUBTITLE	3	Language selection for subtitle.				Selects Photo mode.
VIDEO/ANGLE	4	Plays back disc in different angle for a scene.	Plays back Picture CD with different angle of picture displayed.			Selects Video mode.
MENU	5	Enters the main menu of the disc.	Turns on/off PBC when playing VCD.		Selects Photo mode.	
TITLE	6	Enters the title menu of the disc.	Plays the first ten seconds of each chapter/title.		Selects Music mode.	
CLEAR	7	Delete entry or move backwards to correct error in Direct Access mode.	Delete entry or move backwards to correct error in Direct Access mode.	Delete entry or move backwards to correct error in Direct Access mode.	Delete entry or move backwards to correct error in Direct Access mode.	Delete entry or move backwards to correct error in Direct Access mode.



VM9725BT

Table 1: Remote Control Functions

Button	Function					
Name	#	DVD	VCD	TUNER	CD/MP3/ USB	iPod
	8					
	9	Selects the previous chapter for playback.	Selects the previous chapter for playback.	Searches for an available radio station by decreasing tuning frequency.	Selects the previous track for playback.	Pauses playback/ starts playback.
	10	Selects the next chapter for playback.	Selects the next chapter for playback.	Searches an available radio station by increasing the tuning frequency.	Selects the next track for playback.	Selects the next track for playback.
PIC	11	Displays set-up parameters.	Displays set-up parameters.			
VOL +	12	Increases volume.	Increases volume.	Increases volume.	Increases volume.	Increases volume.
	13	Fast forwards the disc content.	Fast forwards the disc content.		Fast forwards the disc content.	Accesses iPod Menu..
VOL -	14	Decreases volume.	Decreases volume.	Decreases volume.	Decreases volume.	Decreases volume.
	15	Stops playback.	Stops playback.		Stops playback.	



Table 1: Remote Control Functions

Button	Function					
Name	#	DVD	VCD	TUNER	CD/MP3/ USB	iPod
MUTE	16	Toggles on/off audio output.	Toggles on/off audio output.	Toggles on/off audio output.	Toggles on/off audio output.	Toggles on/off audio output.
SCN / *	17			Plays the first ten seconds of each track.		
MIX / #	18	Plays all chapters in random order.			Plays all tracks in random order.	Plays all tracks in random order
1, 2, 3, 4, 5, 6, 7, 8, 9, 0 (Numeric Keypad)	19	Directly accesses chapter.		1-6 selects preset for current band.	Directly accesses track.	
▶▶	20	Press repeatedly for slow motion forward/backward.	Press repeatedly for slow motion forward/backward.			
PRESET ▼	21			Navigates the preset station list.		
◀	22	Slow playback/slow rewind playback.	Slow playback/slow rewind playback.			



VM9725BT

Table 1: Remote Control Functions

Button		Function				
Name	#	DVD	VCD	TUNER	CD/MP3/ USB	iPod
▶/	23	Pauses playback/ starts playback.	Pauses playback/ starts playback.		Pauses playback/ starts playback.	
SETUP	24	Displays Setup menu.	Displays Setup menu.	Displays Setup menu.	Displays Setup menu.	Displays Setup menu.
PRESET ▲	25			Navigates the preset station list.		
RPT	26	Repeats playback of current chapter.	Repeats playback of current chapter.	Repeats playback of current track.	Repeats playback of current track.	
REPT A-B	27	Setup to repeat playback from time frame A to time frame B.	Setup to repeat playback from time frame A to time frame B.			
GOTO	28	Open direct entry search screen.	Open direct entry search screen.			
	29					
BAND	30			Selects FM/AM band.		

VM9725BT



Table 1: Remote Control Functions

Button		Function				
Name	#	DVD	VCD	TUNER	CD/MP3/ USB	iPod
ZOOM	31	Zooms in/ out on an image.	Zooms in/ out on an image.			
DISP	32	Displays playing information.	Displays playing information.	Displays playing information.	Display playing information.	Displays playing information.
MUSIC/ AUDIO	33	Changes the audio language for disc playback.			Selects Music mode.	
EJECT (▲)	34	Ejects the disc.	Ejects the disc.	Ejects the disc.	Ejects the disc.	Ejects the disc.
SRC	35	Selects playing mode.	Selects playing mode.	Selects playing mode.	Selects playing mode.	Selects playing mode.



VM9725BT

OPERATING INSTRUCTIONS

Power On / Off

Press the **Power On/Off (⏻)** button to turn the unit on. The buttons on the front of the unit light up and the current mode status appears on the LCD. Press and hold the button to **Power On/Off (⏻)** power off the unit.

Audible Beep Confirmation

An audible beep tone confirms each function selection. The Beep tone can be disabled through the Setup menu.

Mute

Momentarily press the rotary encoder to activate the MUTE function. Press again to resume normal listening. If the MUTE wire is connected, audio output mutes when a phone call is received by the mobile phone.

Playing Source Selections

Front Source Menu



Source Menu Page 1



Source Menu Page 2

You can use the touch screen to change the source through the SOURCE MENU. To access the SOURCE MENU, touch the top left corner of the screen or press the SRC button. The SOURCE MENU consists of two pages. Swipe across the screen to go from one page to another. Touch the Radio, SXM, F-USB (Front USB), NAV, BT (Bluetooth), AUX1, AUX2, Camera, SOHC, Disc, R-USB (Rear USB) or SWC (Steering Wheel Controls) icons to select the corresponding source.

NOTE: If an iPod® is attached to a USB port, "iPOD" appears instead of the text "F-USB" or "R-USB."



VM9725BT

Rear Source Menu



The Rear Source Menu Screen allows you to select an audio/video source for your vehicle's rear zone. Touch the Disc, SDHC, F-USB (Front USB), R-USB (Rear USB), AUX1 or AUX2 icons to select the corresponding source

NOTE: If an iPod® is attached to a USB port, "iPOD" appears instead of the text "F-USB" or "R-USB."

VM9725BT



External Devices

External peripheral devices, including a game console, camcorder, navigation unit, iPod®, Zune, etc. can be connected to this unit via RCA output using an A/V Media Adapter Cable (not included).

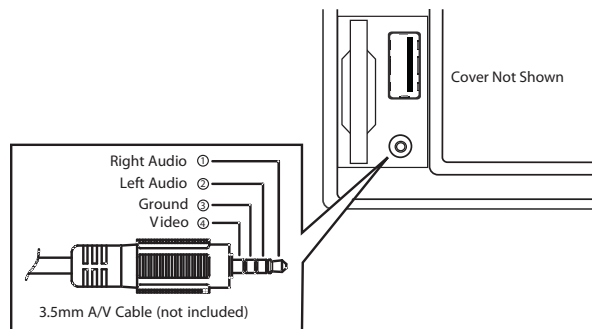

Connect the external device to the A/V Media Adapter Cable and then plug the cable into the A/V INPUT connector on the front of the radio. Select "AUX IN" mode to access auxiliary devices. You cannot directly control external devices connected to the A/V INPUT. For information regarding the use of USB devices, see "Inserting a USB Device or SD Card".

Volume Adjustment

Volume Increase/Decrease

To increase or decrease the volume level, turn the rotary encoder on the front panel. When the volume level reaches "0" or "50", a beep sounds, indicating that the adjustment limit has been reached. The TFT screen displays the volume level for 3 seconds.

Programmable Turn-On Volume

This feature allows the user to select a turn-on volume setting regardless of the volume setting prior to turning the unit off. To program a specific turn-on volume level, turn the rotary encoder to adjust the volume to the desired turn-on volume. Push and hold the rotary encoder while the speaker icon and level indication is displayed on the screen. The unit will beep to confirm your turn-on volume setting.



Equalizer and Balance/Fader Controls

The equalizer and balance/fader controls allow you to easily adjust your audio system to meet the acoustical characteristics of your vehicle, which vary depending on the type of vehicle and its measurements. Proper setting of the Fader and Balance boosts the effects of the cabin equalizer.

Equalizer Screen

Touch the EQ button display the equalizer screen.



Table 2: Equalizer Adjustments

Setting	Adjustable Range	Function
BASS	-12 to +12	Reduces or increases the bass frequency sound level. Touch the + or - buttons to adjust the settings.
MID	-12 to +12	Reduces or increases the mid-range frequency sound level. Touch the + or - buttons to adjust the settings.
TREBLE	-12 to +12	Reduces or increases the high frequency sound levels. Touch the + or - buttons to adjust the settings.

VM9725BT



Preset EQ Selection

Equalizer presets apply a preset sound level to the unit's audio output signal. Touch the User, Acoustic, Urban, Rave, Latin, Dance, Hip Hop or Rock button to change the setting.

***NOTE:** The equalizer will automatically change to "USER" when individual audio functions are adjusted.*

To Exit the Equalizer:

- Touch the **X** button on the top right corner of the screen to return to the source screen.
- Touch the **BAL-FAD** button to display the balance/fader screen.



Balance/Fader Screen

Touch the **BAL-FAD** button on the left side of the equalizer screen to display the balance/fader screen.

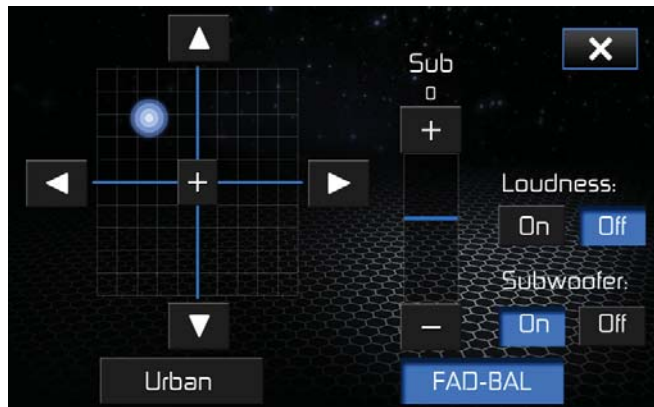

◀ or ▶ (Balance) icon:

Balances the audio output levels between the left and right side of the vehicle. Touch the ◀ or ▶ icon to change the setting.

▲ or ▼ (Fade) icon:

Balances the audio output levels between the front and back side of the vehicle. Touch the ▲ or ▼ icon to change the setting.

Sub icon:

Reduces or increases the subwoofer sound level. Touch the + or - buttons to adjust the settings.

Loudness On/Off icon:

Loudness automatically alters the frequency response curve of audio to make it sound more natural when played at a lower volume level. Press the **On** icon to turn loudness compensation on. Press the **Off** icon to turn loudness compensation off.

Subwoofer On/Off icon:

Press the **On** icon to turn the vehicle's subwoofer on (if equipped). Press the **Off** icon to turn the vehicle's subwoofer off.

To Exit the Balance-Fader:

- Touch the **X** button on the top right corner of the screen to return to the source screen.
- Touch the **EQ** button to display the equalizer screen.

VM9725BT



System Reset

To correct a system halt or other illegal operation, use the tip of a pen to press the reset button located over the rotary encoder. After a system reset, the unit restores all factory default settings.

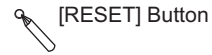

NOTE: *If the unit is reset while a DVD is playing, the DVD resumes play once the reset is complete.*

Image/Display Settings

Video Output Modes

Table 3 shows the video output mode for each playing source.

Table 3: Video Output Modes

Playing Source	Video Output Modes
AM/FM TUNER	YCbCr Mode
DVD	YCbCr Mode
AUX IN	CVBS* Mode

*CVBS – Composite Video Baseband Signal

Parking Brake Inhibit

- When the pink “Parking” wire is connected to the vehicle Parking Brake circuit, the front TFT monitor will display video when the Parking Brake is engaged. (When the pink wire is grounded via the Parking Brake circuit, video will be displayed.)



VM9725BT

STEERING WHEEL CONTROLS (SWC) (if equipped)

The VM9725BT is compatible with the PAC (Pacific Accessory Corporation) SWI-PS and Metra ASWC steering wheel control adapters. A 3.5 mm female connector (labeled "SWC Interface") on the back of the head unit allows connectivity to the adapters. Please refer to the instructions included with the adapters for detailed installation information.

SWC Functions

The following controls are available for most vehicles:

1. Volume Up
2. Volume Down
3. Mute
4. Seek Up
5. Seek Down
6. Source
7. Band
8. Bluetooth Send
9. Bluetooth End

**All SWC functions may not be available on some vehicles.

SETTINGS MENU

When using the VM9725BT for the first time, it is recommended that you customize the system settings to suit your preferences. You may also change the settings at any time.

To access system settings:

1. Touch the **Settings** button on the Source Menu screen to enter the SETTINGS MENU. The General Sub-menu appears highlighted in blue.



2. Touch a sub-menu name icon (Video, General, Time, etc.) to select a sub-menu. The settings available for adjustment under the highlighted sub-menu option will appear in the left of the screen.
3. Touch an item on the touchscreen to select the setting to be adjusted. Touch the ▲ or ▼ icon to scroll up or down the settings list page, if applicable. An options field, showing the current selected option, appears on the right.
4. Touch the option field to change the setting you want to adjust. The setting option is updated.

Video Sub-menu Settings

Setting	Options	Function
Aspect Ratio	Full	The entire screen is extended horizontally to the aspect ratio of 16 to 9. The extension ratio is the same at any point.
	Normal	The conventional display image has a 4 to 3 ratio of horizontal to vertical, leaving a blank area on the right and left sides of the display.
Rear Camera	Mirror	Reverse the camera image as if looking through a rear-view mirror.
	Normal	
Rear Camera Audio	On	Enable rear camera audio function.
	Off	Disable rear camera audio function.



VM9725BT

NOTE: If the rear-view video camera is connected and the unit is on, Camera mode is selected upon shifting into REVERSE gear. If the monitor is in display mode, the monitor automatically switches to CAMERA mode upon reverse driving. When the reverse driving stops, the monitor returns to its original input mode.

General Sub-menu Settings

Setting	Options	Function
User Interface Color	Aqua	This setting allows the user to select five pre-defined LED colors for the front panel illumination.
	Red	
	Blue	
	Amber	
	Green	
Tuner Region	USA	<ul style="list-style-type: none"> • AM Frequency Spacing - 10 kHz • AM Frequency Band - 530 kHz ~ 1720 kHz • FM Frequency Spacing - 200 kHz • FM Frequency Band - 87.5 MHz ~ 107.9 MHz
	Europe	<ul style="list-style-type: none"> • AM Frequency Spacing - 9 kHz • AM Frequency Band - 522 kHz ~ 1620 kHz • FM Frequency Spacing - 50 kHz • FM Frequency Band - 87.5 MHz ~ 108.0 MHz
TFT Standby	Off	Screen remains on continuously.
	10s	Screen goes blank (standby mode) after 10 seconds of inactivity. Touch the screen to exit standby and view the display.
	20s	Screen goes blank (standby mode) after 20 seconds of inactivity. Touch the screen to exit standby and view the display.
Dimmer Mode	Auto	This setting dims the LCD screen when the vehicle's headlights are turned on. Five settings are pre-defined.
	Night	
	Dark	
	Normal	
	Bright	
RGB Light	Adjust	This setting allows the user to tune the RGB colors of the LEDs to obtain an exact match for their vehicle.

VM9725BT



Beep	Off	No beep sounds.
	On	When turned on, an audible beep tone confirms each function selection.
Background	Animation Star	Allows the user to select a screen background. The Wallpaper will not appear on the Main Source Menu, Camera source or EQ settings page.
	Starry Sky	
	Black	
	Animation Fireworks	
	Animation Wave	
	User Defined	
Calibration	Start	Press to access the touch screen calibration function.
Demo	On	Display various user interface TFT display pages.
	Off	Displays the Equalizer and Settings menu pages.

Touch Screen Calibration

To access the "Touch Screen Calibration" function from the General sub-menu:

1. Select the "Calibration" Start option. A calibration test pattern appears on the screen.
2. To begin calibration, touch and hold the crosshair (+) that appears in the "1" icon in the center of the screen. After about one second, the crosshair moves to the "2" icon in the quadrant.
3. Continue for each quadrant until the calibration is completed.

Demo Mode Features

The Demo mode is to On (Auto run) by default. The Demo mode will display various user interface TFT display pages such as the Radio, Disc, Aux In, and Camera sources. The Demo mode will also display the Equalizer and Settings menu pages. Touching any portion of the touch screen will pause the Demo mode temporarily. If the touch screen is not pressed again (within 30 seconds) the Demo mode will resume.

To turn the Demo mode off, access the General Sub-menu Settings and turn Demo to Off.



VM9725BT

Time Sub-Menu Settings

Setting	Options	Function
Date	mm/dd/ yyyy	
Clock Mode	12Hr	Clock displays 12 hour time using AM and PM.
	24Hr	Clock displays 24 hour time up to 23:59.
Time	(HH:MM)	Clock appears in the top right corner of the screen during certain operations. <i>NOTE: The AM/PM indication will change as you continue to adjust the hour past 12.</i>

Sound Sub-menu Settings

Setting	Options	Function
Sub Woofer Filter	80 Hz	Select a crossover frequency to set a cut-off frequency for the subwoofer's LPF (low-pass filter).
	120 Hz	
	160 Hz	
DRC	Off	Employ the Dynamic Range Control for better playback for low volumes.
	On	



Language Sub-menu Settings

If a DVD supports more than one subtitle or audio language, all the languages are available for selection during playback. If the selected language is not supported by the DVD, then the default language is used.

Setting	Options	Function
OSD	English	On Screen Display appears in English.
	French	On Screen Display appears in French.
	Portuguese	On Screen Display appears in Portuguese.
	Spanish	On Screen Display appears in Spanish.
DVD Audio	English	Audio is heard in English when the option is available.
	French	Audio is heard in French when the option is available.
	Portuguese	Audio is heard in Portuguese when the option is available.
	Spanish	Audio is heard in Spanish when the option is available.
DVD Subtitle	English	DVD subtitles automatically appear in English when available.
	French	DVD subtitles automatically appear in French when available.
	Portuguese	DVD subtitles automatically appear in Portuguese when available.
	Spanish	DVD subtitles automatically appear in Spanish when available.
	Off	DVD subtitles do not appear.
Disc Menu	English	DVD menu (if applicable) is displayed in English.
	French	DVD menu (if applicable) is displayed in French.
	Portuguese	DVD menu (if applicable) is displayed in Portuguese.
	Spanish	DVD menu (if applicable) is displayed in Spanish.



VM9725BT

Bluetooth Sub-Menu Settings

Setting	Options	Function
Bluetooth	On	Enable Bluetooth function.
	Off	Disable Bluetooth function.
Auto Connect	On	Connect the last active mobile phone by touching the Pair icon when disconnected.
	Off	Automatically connect when your paired phone is in range
Auto Answer	On	The unit automatically answers all incoming calls.
	Off	Manually answer calls by touching the call  icon.
Microphone	Internal	Selects internal microphone for Bluetooth calls.
	External	Selects external microphone for Bluetooth calls (if installed).
Pairing Code	xxxx	The default code is "1234" or "0000" depending on the phone. Touch the keypad icon to open the keypad and enter the pairing code or pass key required for Bluetooth connection to your mobile phone. Not all phones/devices require a pairing code.



DVD Rating Sub-menu Settings

The DVD system has a built-in parental lock feature to prevent unauthorized persons from viewing restricted disc content. By default, the rating system is unlocked. Once set up, the parental lock is released only by entering the correct password. Once the password is entered, rating is available for setup.

Setting	Options	Function
Set Password	----	Enter a 4-digit password to activate the "Rating" feature
Rating Level	Kid Safe	Select the appropriate rating level for the intended audience. You may override higher ratings by using your password.
	G	
	PG	
	PG-13	
	PG-R	
	R	
	NC-17	
Adult		
Factory Default	Reset	Select "Reset" to restore the factory default settings for the Rating system only.
OS		Current OS version.
MPU		Current MPU version.
MCU		Current MCU version.
MPEG		Current MPEG version.

To reset the password, access the "Rating Level" option and enter the current password. Once the correct password is entered, you can access the "Password" field and enter a new one.

NOTE: Record the password and keep it in a safe place for future reference. The rating for each disc is marked on the disc, disc packing or documentation. If the rating is not available on the disc, the parental lock feature is unavailable. Some discs restrict only portions of the disc, allowing the appropriate content will play. For details, please refer to the disc description.



Volume Sub-menu Settings

Setting	Options	Function
DVD	0 - 12	Increase or reduce the relative DVD volume.
USB	0 - 12	Increase or reduce the relative USB volume.
SD	0 - 12	Increase or reduce the relative SD volume
Radio	0 - 12	Increase or reduce the relative radio volume.
Bluetooth	0 - 12	Increase or reduce the relative Bluetooth volume.
AV-IN1	0 - 12	Increase or reduce the relative AV-IN1 volume.
AV-IN2	0 - 12	Increase or reduce the relative AV-IN2 volume.
Navigation	0 - 12	Increase or reduce the relative navigation volume.
iPod	0 - 12	Increase or reduce the relative iPod® volume.
SXM	0 - 12	Increase or reduce the relative SiriusXM® volume.

Exiting the System Settings Menu

To exit setup mode and resume normal playback, touch the **Setting** button on the screen.

TUNER OPERATION

Tuner TFT Display Screen



1. **RADIO** icon: Touch to view the SOURCE MENU and select a new playback source.
2. Current radio band indicator.
3. Stereo broadcasting indicator.
4. **Local/Distance** Indicator: Strong local signal broadcasting indicator.
5. Equalizer setting indicator: Displays the current equalizer preset setting.
6. **EQ** icon: Touch for quick access to Equalizer level settings screen.
7. Clock: Displays the time as entered by the user in the settings menu.
8. Program Information: This indicator provides three types of information: PS, RT, and PTY. PTY displays the program category of the current station such as category (news, sports, talk etc.). RT/PS provide the current song title, current song title, performing artist, and station call letters.
9. Radio frequency indicator.
10. **▶▶** icon: Touch to seek forward .
11. **▶** icon: Touch to tune forward one step.
12. **◀** icon: Touch to tune backward one step.
13. **◀◀** icon: Touch to seek backward.
14. **Option** icon: Touch to display the Options Screen.
15. **Mute** icon: Press this icon to mute the audio output of the unit. Press again to un-mute the volume.
16. **Direct Entry** icon: Touch to access the direct entry screen.
17. **AS**: Touch to automatically store stations.
18. **Band** icon: Touch to change between AM/FM bands.
19. Presets provides a display of the preset frequencies. Touch to recall preset stations.



VM9725BT

Options Screen

Touch the **Options** icon to display the Options Screen.



RDS ON/OFF:

Radio Data System (RDS) enables traffic reports to be received and provides many facilities, including enabling the radio station name to be displayed on the radio display.

CT ON/OFF:

(Clock Time, RDS feature) When enabled the radio system clock is synchronized with broadcasters time signal setting the clock automatically. In some regions where daylight savings time is not adhered to, the system clock will be off by 1 hour. In these cases, set CT to OFF and manually set the clock.

Mode Local/Distance:

This allows the user to activate local station reception function. When the Local function is on, only radio stations with a strong local radio signal are played.

PTY List:

Program type (PTY) allows users to find similar programming by genre. Touch to access the program type search screen.

VM9725BT



Switching to Radio Tuner Source

- Touch the top left corner of the screen (the RADIO box) to view the SOURCE MENU. Touch "Radio".
- Press the **SRC** button on the front panel to switch to the AM/FM or RADIO source.

Selecting FM/AM Band

Touch the **BAND** icon on the screen to change between the following bands: FM1, FM2, FM3, AM1, and AM2.

Tuning to a Station

Seek Tuning

To seek the next higher station, touch the ►► icon.
To seek the next lower station, touch the ◀◀ icon.

Manual Tuning

To increase or decrease the tuning frequency one step, touch the ◀ or ► icon.

Direct Tuning

1. To enter a radio station directly, touch **Direct Entry** to display the Direct Entry Menu.



2. Enter the desired radio station frequency using the on-screen number pad. If you wish to delete an entry number touch the red **X** on the keypad. Press **ok** to tune to the selected station. To exit the screen without changing the station, touch the **X** in the upper right corner.



Using Preset Stations

Six numbered preset buttons store and recall stations for each band. All six stored stations (P1-P6) for the current band appear on the screen.

Storing a Station

1. Select a band (if needed), then select a station.
2. Touch the on-screen **Mem** icon to access the Preset Screen.



3. Touch the preset number in which you would like to store the current station (or touch **X** to cancel and close the menu). The station frequency is displayed at the top of the menu. The preset number will appear highlighted. The station frequency will be stored in the highlighted preset. The station will be displayed on the Tuner TFT Display Screen.

Recalling a Station

1. Select a band (if needed).
2. Touch an on-screen preset icon to select the corresponding stored station.



VM9725BT



Auto Store (AS)

Auto Store is most useful when travelling in an area where you are not familiar with the local stations. The Auto-Store Tuning feature will automatically scan and enter up to eighteen FM strong stations into the preset memory locations for the FM1, FM2 and FM3 bands or twelve strong AM stations into the preset memory locations for the AM1 and AM2 bands. Each band stores up to six preset stations.

To select six strong stations and store them in the current band:

1. Select a band (if needed).
2. Touch the **AS** icon on the on-screen controls to activate the Auto Store function. The Auto Store Search Screen appears.



The radio searches from the current frequency and checks the signal strength until one cycle search is finished. The new stations replace stations already stored in that band. If you have already set the preset memories to your favorite stations, activating the Auto-Store feature will erase those stations and enter the new strong stations.



Search for Station by Program Type

Program type (PTY) allows users to find similar programming by genre.

1. From the Tuner TFT Display, touch the **Options** icon to display the Options Screen.
2. Touch the **PTY List** icon to display the Program Type Screen.



3. Touch a program type, then touch the **Search** icon. The unit searches for the respective stations and stops when a station is found.
Note: Touch the ▲ or ▼ icon to scroll up or down the page.

Local Radio Station Seeking

When the Local function is on, only radio stations with a strong local radio signal are played.

To activate the Local function in the AM/FM tuner mode:

1. Touch the **Options** icon on the Tuner TFT Display Screen. The Options Screen appears.
2. Touch the **Mode Local/Distance** icon to turn the local function on or off.

When the Local function is active, the Local indicator at the top of the screen is illuminated. When the Distant function is active, the Distance indicator at the top of the screen is illuminated.

DVD/VCD VIDEO OPERATION

NOTE: When properly installed, DVD video cannot be displayed on the main TFT screen unless the parking brake is applied. If you attempt to play a DVD while the vehicle is moving, the TFT screen displays:

DVD/VCD TFT Display

WARNING !!!





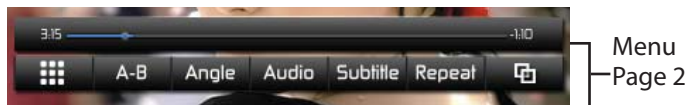



It is illegal to view video while driving or operating a motor vehicle. Set the parking brake to view video.

To access the on-screen controls, touch the bottom 1/3 of the screen while a DVD is playing. Touch  to view a second page of controls.







Menu Page 1

1. Elapsed Time Indicator: Displays the total playing time and elapsed of the current movie playing.
2.  icon: Touch to select a chapter/track directly using the on-screen display direct entry menu display.
3.  icon: Touch to stop DVD playback.
4.  icon: Touch to move to previous chapter.
5.  (Pause / Play) icon: Touch the  icon to pause playback. Touch the  icon to begin playback.
6.  icon: Touch to advance to the next chapter on the DVD.
7. **Mute** icon: Press this icon to mute the audio output of the unit. Press again to un-mute the volume.
8.  icon: Touch to go to Menu Page 2.

Menu Page 2

9.  icon: Touch to select a chapter/track directly using the on-screen display direct entry menu display.
10. **A-B** icon: Touch to repeat a specific portion from point A to point B of the DVD disc.
11. **Angle** icon: Touch to view angles if the DVD contains scenes shot from different angles.
12. **Audio** icon: Touch during playback to select to select the audio language. Each time the icon is touched a different audio language is selected if you are watching a disc recorded in multiple languages.
13. **Subtitle** icon: Touch during playback to select the subtitle language if the disc is recorded in multiple languages. Each time the icon is touched a different subtitle language is selected. The subtitle function can also be turned on or off.
14. **Repeat** icon: Touch during playback to repeat the current chapter. Touch the icon a second time to repeat the current title. Touch the icon a third time to turn the repeat function off.
15.  icon: Touch to go to Menu Page 1.



Controlling Playback

Inserting a Disc

Upon inserting a DVD disc, DVD mode is entered and disc play begins.

NOTE: If Parental Lock (Rating) is activated and the disc inserted is not authorized, the 4-digit code must be entered and/or the disc must be authorized (see "Rating Sub-menu Features").

You cannot insert a disc if there is already a disc in the unit or if the power is off.

NOTE: DVD-R and DVD-RW will not play unless the recording session is finalized and the DVD is closed.

Ejecting a Disc

Press the **EJECT** (▲) button on the front of the unit to eject the disc. The unit automatically reverts to Tuner mode. You may eject a disc with the unit powered off. The unit will remain off after the disc is ejected.

Resetting the Loading Mechanism

If the disc loads abnormally or an abnormal core mechanism operation occurs, touch and hold the **EJECT** (▲) button to reset the loading mechanism. Normal operation resumes.

Accessing DVD Mode

To switch to DVD mode when a disc is already inserted, touch **SRC** on the front panel to access the source menu. Touch the disc icon.

Repeat Playback

Touch the **Repeat** icon to alter repeat mode in the following sequence:

- DVD: Repeat Chapter, Repeat Title, Repeat Off
- VCD (PBC Off): Repeat Single, Repeat Off

NOTE: For VCD play, the repeat function is not available if PBC is on.



VM9725BT

Sectional Repeat Function (A-B)

Use the **A-B** function to define a specific area of a disc to repeat.

- Touch **A-B** on the second page of DVD on-screen controls to set the start point (A) of the repeated section.
- Touch **A-B** again once you reach the desired end point (B) of the repeated section. The selected portion of the DVD will now repeat continuously.
- Touch **A-B** a third time to cancel the A-B section setting and stop repeat play.

Accessing the DVD Source Menu

- Press the **MENU** button on the remote control to recall the DVD source menu. Touch to select a title from the menu.
- Touch the **TITLE** button on the remote control to select a different title for playback.
- Select a title using the touch screen.

Moving Through Chapters

Touch the **▶▶** icon to advance to the next chapter.

Touch the **◀◀** icon to move to the previous chapter.

Direct Chapter / Track Selection

To select a chapter/track directly, touch the on-screen **■** icon to display the direct entry menu.

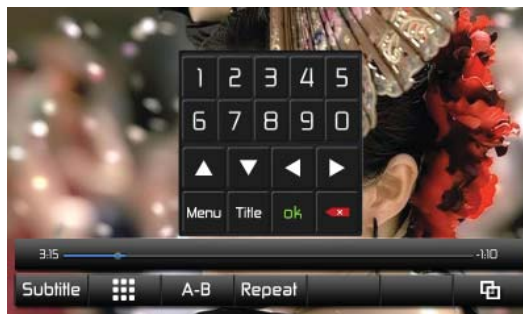

Enter the desired chapter/track using the on-screen number pad. Touch the **ok** icon to enter your selection. To clear an entry and start over, touch the red **X** icon.

Viewing an Alternate Picture Angle (DVD Only)

Some DVDs contain scenes that have been shot simultaneously from different angles. For discs recorded with multiple angles, touch **Angle** on the second page of DVD on-screen controls to toggle available angles of the on-screen image.



Multi-Language Discs (DVD Only)

Changing Audio Language

If you are watching a disc recorded in multiple languages, touch **Audio** on the second page of DVD on-screen controls to choose a language. Each time the icon is touched the language will change.

Changing Subtitle Language

If you are watching a disc recorded in multiple languages with subtitles, touch **Subtitle** on the second page of DVD on-screen controls to choose the language in which you would like the subtitles to appear.

NOTE: During VCD playback, touch the AUDIO on the second page of DVD on-screen controls to choose between Left Channel, Right Channel, and Stereo.

PBC - Play Back Control (VCD Only)

For VCDs with play back functionality, play back control (PBC) provides additional controls for VCD playback.

Touch PBC on the first page of DVD on-screen controls to toggle the PBC function "On"/"Off". Once PBC is on, playback starts from track one of the play list.

NOTE: When PBC is activated, fast forward, slow playback, and previous/next track are available. Repeat and direct track selection are not available.

When PBC is activated, selecting random, scan or search playback automatically deactivates PBC.

Playback Information

During DVD and VCD playback, touch the center of the screen to display playback information on the screen, including the media playing and current playback time.

DVD Playback Information

- DVD Video – Format of current disc.
- Time 00:01:30/00:36:10 – Indicates the playback time of the current track.
- Title 5/08 – Indicates the fifth of 8 titles on the DVD is currently playing.
- Chapter 2/16 – Indicates that the second of 16 chapters on the DVD is currently playing.

VCD Playback Information

- VCD2.0 – Format of current disc.
- Time 00:01:30/00:36:10 – Indicates the playback time of the current track.
- PBC On/Off – Indicates whether Play Back Control is On or Off.



VM9725BT

General Disc Information

Table 4: Disc Properties













Symbol	12 cm Disc Properties	Max Play Time
	Single side single layer (DVD-5)	(MPEG 2 Method)
	Single side double layer (DVD-9)	133 minutes
	Double side single layer (DVD-10)	242 minutes
	Double side double layer (DVD-18)	266 minutes
	Double side double layer (DVD-18)	484 minutes
	Single side single layer (VCD)	(MPEG 1 Method)
	Single side single layer	74 minutes

Table 5: Disc Symbols

Symbol	Meaning
	Number of voice languages recorded. The number inside the icon indicates the number languages on the disc (maximum of 8).
	Number of subtitle languages available on the disc (maximum of 32).
	Number of angles provided (maximum of 9).
	Aspect ratios available. "LB" stands for Letter Box and "PS" stands for Pan/Scan. In the example on the left, the 16:9 video can be converted to Letter Box video.
	Indicates the region code where the disc can be played. <ul style="list-style-type: none"> • Region 1: USA, Canada, East Pacific Ocean Islands • Region 2: Japan, Western Europe, Northern Europe, Egypt, South Africa, Middle East • Region 3: Taiwan, Hong Kong, South Korea, Thailand, Indonesia, South-East Asia • Region 4: Australia, New Zealand, Middle and South America, South Pacific Ocean Islands/Oceania • Region 5: Russia, Mongolia, India, Middle Asia, Eastern Europe, North Korea, North Africa, North-West Asia • Region 6: Mainland China • ALL: All regions

VM9725BT



DVD/CD AUDIO OPERATION

Instructions for TFT control and Insert/Eject are the same for DVD and CD operation. Please see the DVD/Disc Video Operation section for information about these topics.

Media Requirements

The VM9725BT will play music or other audio files from the following disc media:

- CD-DA
- CD-R/RW
- DVD
- DVD+R/RW
- DVD-R/RW

Upon inserting a disc, the disc and track title (if available), along with the track number and playing time appear on the screen.

CD TFT Display

The on-screen indicators and touch key areas for CD playback are outlined below.





VM9725BT

1. **Disc** icon: Touch to view the SOURCE MENU and select a new playback source.
2. **Track Indicator**: Displays the current track number playing and total number of tracks on disc.
3. **EQ** : Touch for quick access to the Equalizer level settings menu.
4. **Clock**: Displays the time as entered by the user in the settings menu.
5. **↻** (Repeat) icon: Touch to alter repeat mode as follows: Repeat Single > Repeat Folder > Repeat All > Repeat Off
6. **⌘** (Random) icon: Touch to alter random mode as follows: Random On > Random Off
7. **▶▶** (Next) icon: Touch to play the next track.
8. **■ / ▶** (Pause / Play) icon: Touch the **■** icon to pause playback. Touch the **▶** icon to begin playback.
9. **◀◀** (Previous) icon: Touch to play the previous track.
10. **List** icon: Touch to display the Playlist screen.
11. **Elapsed time Indicator**: Displays the elapsed and total playing time of the current track playing.
12. **Playback Information Display**: Displays song, artist, and album information.

VM9725BT



Playlist Screen

The Playlist screen allows you to directly search for music on your disc.



- Touch a track title (if available) or track number to begin playback of that track.
- Touch the ▲ or ▼ icon to scroll up or down the page.
- Touch the **Search** icon to access the Disc Search Screen.

Disc Search Screen



Enter the desired track the on-screen number pad. If you wish to delete an entry number touch the red **X** on the keypad. Press **ok** to play to the selected track. To exit the screen without changing the station, touch the **X** in the upper right corner.



VM9725BT

Controlling Playback

Inserting a Disc

Upon inserting a CD, disc play begins. You cannot insert a disc if there is already a disc in the unit or if the power is off.

Ejecting a Disc

Press the **EJECT** (▲) button on the front of the unit to eject the disc. The unit automatically reverts to Tuner mode.

You may eject a disc with the unit powered off. The unit will remain off after the disc is ejected.

Resetting the Loading Mechanism

If the disc loads abnormally or an abnormal core mechanism operation occurs, press and hold the **EJECT** (▲) button to reset the loading mechanism. Normal operation resumes.

Pausing/Resuming Playback

Touch the **⏸** icon to pause playback. Touch the **▶** icon to resume playback.

Moving Through Tracks

Touch the **▶▶** icon to advance to the next track on the disc.

Touch the **◀◀** icon to move to the previous track.

Repeat Playback

Touch the **↺** icon to alter repeat mode according to the following:

- DVD: Repeat Single > Repeat Folder > Repeat All > Repeat Off
- CD-DA: Repeat Single > Repeat Folder > Repeat All > Repeat Off
- CD-R/RW: Repeat Single > Repeat Folder > Repeat All > Repeat Off
- DVD-R/RW: Repeat Single > Repeat Folder > Repeat All > Repeat Off
-

Random Play Select

Touch the **⤵** icon to play the tracks on the disc in a random, shuffled order. Touch the **⤴** icon again to cancel Random Play mode.

NOTE: CD-R and CD-RW will not play unless the recording session is finalized.



MP3/WMA OPERATION

Instructions for TFT control and Insert/Eject are the same for DVD and MP3 operation. Please see the DVD/Disc Video Operation section for information about these topics.

Media and File Requirements

This player allows you to play back MP3 and WMA files recorded onto CD-R/RWs, DVD+R/RWs, and DVD-R/RWs. For CD-RW discs, please make sure it is formatted using the full method and not the quick method to prevent illegal disc operation. For the greatest file capacity, Dual Layer DVD's can be used when burning music to a disc. .

MP3 Format Compatibility

The file naming formats listed below are compatible with this unit:

- ISO 9660 – file name: 12 characters, file extension: 3 characters
- ISO 9660 – file name: 31 characters, file extension: 3 characters
- Joliet – 64 characters

If the file or folder name does not conform to ISO 9660 file system standards, it may not be displayed or played back correctly. Use the following settings when compressing audio data for your MP3 disc:

- Transfer Bit Rate: 128 kbps
- Sampling Frequency: 48 kHz

When recording MP3 up to the maximum disc capacity, disable additional writing. For recording on an empty disc up to maximum disc capacity, use the "Disc at once" setting.

MP3 Playing Order

When selected for play, files and folders (Folder Search, File Search or Folder Select) are accessed in the order they were written by the CD writer. As a result, the order in which they are expected to be played may not match the order in which they are actually played. You may be able to set the order in which MP3/WMA files are to be played by writing them onto a medium such as a CD-R with their file names beginning with play sequence numbers such as "01" to "99".



VM9725BT

For example, a medium with the following folder/file hierarchy is subject to Folder Search, File Search or Folder Select, as shown below.

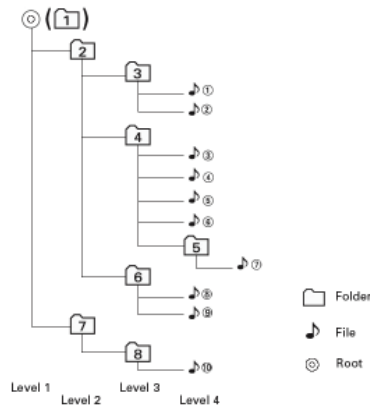

The VM9725BT player will only recognize three folder levels and does not display folders containing only other folders. In the example above, the unit will display folders 3, 4, 6, and 8, but not 2 and 7 since they do not contain any tracks directly. Folder 5 is not recognized at all since it is at the fourth level.

Inserting a USB/SD Card Device

NOTE: Front and rear USB ports are for either Apple iPod® / iPhone® devices, USB memory sticks or portable HDD. The rear 3.5 mm connector (bundled with the USB port) is for iPod® / iPhone® video only. The USB/SD ports will recognize most USB/SD flash memory devices and portable hard drives. The unit supports 8GB SD cards however SD cards larger than 8GB may not be recognized. Portable hard drives (hard drives must be formatted to FAT32 and NTFS is not supported).

1. Locate the USB/SD connector on the front of the radio.

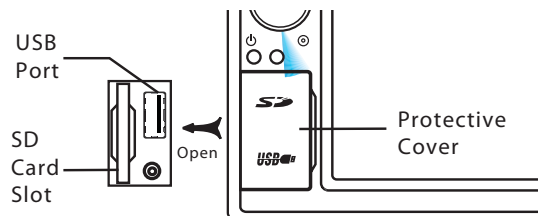

2. Lift the protective cover to reveal the USB/SD slots.
3. Insert the USB/SD device into the USB/SD connectors. The unit will read the audio/video files on the USB/SD device automatically.

To remove the USB/SD device, press the **SRC** button or use the SOURCE MENU to switch to another mode, and then remove the USB/SD device from the connector.

VM9725BT



MP3/WMA TFT Display

The on-screen indicators and touch key areas for MP3/WMA playback are outlined below.



1. **Disc** icon: Touch to view the SOURCE MENU and select a new playback source.
2. Track Indicator: Displays the current track number playing and total number of tracks on disc.
3. EQ : Touch for quick access to the Equalizer level settings menu.
4. Clock: Displays the time as entered by the user in the settings menu.
5. (Repeat) icon: Touch to alter repeat mode as follows: Repeat Single > Repeat Folder > Repeat All > Repeat Off
6. (Random) icon: Touch to alter random mode as follows: Random On > Random Off
7. (Next) icon: Touch to play the next track.
8. (Pause / Play) icon: Touch the to pause playback. Touch the to begin playback.
9. (Previous) icon: Touch to play the previous track.
10. List icon: Touch to display the Playlist screen.
11. Elapsed time Indicator: Displays the elapsed and total playing time of the current track playing.
12. Playback Information Display: Displays song, artist, and album information.



VM9725BT

Playlist Screen

The Playlist screen allows you to directly search for music, video or photo files stored on your MP3 disc/USB device.



- Touch a folder to view the contents of the directory or touch a track title/file name to begin playback of that file.
- Touch the ▲ or ▼ icon to scroll up or down the page.
- Touch the **Search** icon to access the Disc Search Screen.

Disc Search Screen



Enter the desired track the on-screen number pad. If you wish to delete an entry number touch the red **X** on the keypad. Press **ok** to play to the selected track. To exit the screen without changing the station, touch the **X** in the upper right corner.



Search Playlist by File Type

1. Touch the **MUSIC ▲** icon.
2. Touch "MUSIC," "PHOTO" or "VIDEO". The list of files that appear will be filtered by the type of file selected.

Controlling Playback

Inserting a Disc

Upon inserting a MP3/WMA disc, disc play begins. You cannot insert a disc if there is already a disc in the unit or if the power is off.

Ejecting a Disc

Press the **EJECT (▲)** button on the front of the unit to eject the disc. The unit automatically reverts to Tuner mode.

You may eject a disc with the unit powered off. The unit will remain off after the disc is ejected.

Resetting the Loading Mechanism

If the disc loads abnormally or an abnormal core mechanism operation occurs, press and hold the **EJECT (▲)** button to reset the loading mechanism. Normal operation resumes.

Playing MP3/WMA Files

After inserting a MP3/WMA disc, files will play in the sequence of the "Root" directory.

NOTE: When burning MP3 / WMA files onto a DVD disc, use the 2X or 4X burning option, if available. This slower burning speed will help eliminate buffer errors and increase disc reading reliability. Also, use folders when burning large numbers of songs / files to a disc for easy music navigation. Select the "Disc at Once" option and close your disc.





VM9725BT

Pausing/Resuming Playback

Touch the  icon to pause playback. Touch the  icon to resume playback.

Moving Through Tracks



Touch the Next () icon to advance to the next track on the MP3 disc/USB device. Touch the Previous () button to move to the previous track on the MP3 disc/USB device.

Repeat Playback

Touch the  (Repeat) icon to alter repeat mode as follows: Repeat Single > Repeat Folder > Repeat All > Repeat Off

NOTE: CD-R and CD-RW will not play unless the recording session is finalized.

Random Play Select

Touch the  (Random) icon to play the tracks on the MP3 disc/USB device in a random, shuffled order. Touch the  icon again to cancel Random Play mode.

VM9725BT



iPod®/iPhone® OPERATION

NOTE: Be sure your iPod® has the latest Apple firmware installed to avoid connectivity issues.

Accessing iPod® Mode

This unit is Made for iPod® and iPhone®. You can control your iPod® via touch screen to access Playlist, Artist, Albums, Songs, etc. Supported models include, but are not limited to the following:

- iPhone® 4S / 4 / 3GS / 3G and 1st Generation
- iPod touch® 4th / 2nd and 1st Generation
- iPod nano® 6th / 5th / 4th and 3rd Generation
- iPod classic® and iPod® with video

The unit will automatically switch to iPod® mode when an iPod®, iPod touch® or iPhone® is plugged into the front or rear USB connector.

NOTE: For basic iPod® connectivity, you can use the white 30-pin to USB iPod® cable that came with your Apple device . For iPod® video or photo playback, you must purchase the jLink-USB cable.

To return to the iPod® menu from any other source menu, touch **SRC** on the front panel until the iPod® menu appears on the screen, or choose the iPod® icon from the source menu (only available when an iPod® or iPhone® is connected to the USB connector).

NOTE: To transmit the video from your iPod® to the VM9725BT screen, you must set the following options through the iPod® video settings menu:
TV Out = On, TV Signal = NTSC, and Widescreen = On.

NOTE: After disconnecting your iPod®, the VM9725BT will always return to the last mode accessed when the iPod® is plugged back into the unit.











VM9725BT

Indicators/Controls

The on-screen indicators and touch key areas for iPod® playback are outlined below.



1. **iPod** icon: Touch to view the SOURCE MENU and select a new playback source.
2. 1/25 indicator: File number and total number of files on the disc.
3. EQ  icon: Touch for quick access to Equalizer level settings.
4. Clock: Displays the time as entered by the user in the settings menu.
5. Pandora icon: Touch to play Pandora Radio. The Pandora app on your iPod® must be launched.
6.  (Repeat) icon: Indicates the repeat function is enabled. Touch to alter repeat mode as follows: Repeat Once > Repeat All > Repeat Off.
7.  (Random) icon: Indicates the random function is enabled. Touch to alter random mode as follows: Random On > Random Off.
8.  (Next) icon: Touch to play the next track.
9.  (Pause / Play) icon: Touch the  icon to pause playback. Touch the  icon to begin playback.
10.  (Previous) icon: Touch to play the previous track.
11. List icon: Touch to access the Search Screen.
12. Elapsed time Indicator: Displays the elapsed and total playing time of the current track playing.
13. Track information: Song title, album, and performing artist.



VM9725BT



Search Menu

The Search Menu allows you to search for playlists, artists, albums, songs, genres, composer, podcast or audio book.



1. **iPod** icon: Touch to view the SOURCE MENU and select a new playback source.
2. **1/25** indicator: Indicates the file number playing and total number of files in the category.
3. **EQ**  icon: Touch for quick access to Equalizer level settings.
4. Clock: Displays the time as entered by the user in the settings menu.
5. Scroll Bar icon: Touch ▲ or ▼ to scroll up or down the page.
6. **Search** icon: Touch to display the Direct Track Entry screen.
7. **Music ▲** icon: Touch **Music ▲**, then touch **Music ▲**, **Photo ▲** or **Video ▲**. The list of files that appear will be filtered by the type of file selected.
8.  icon: Touch to return to a previous menu.



Direct Track Entry

To select a track directly:

1. Touch the **Search** icon on the Search Menu to display the direct entry menu.

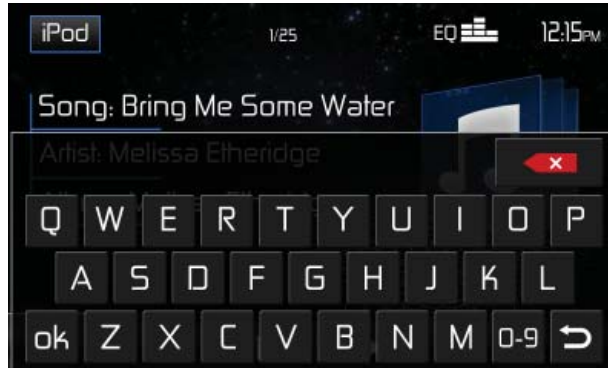

2. Enter the desired track the on-screen key pad. If you wish to delete an entry number touch the red **X** on the keypad. Press **ok** to play to the selected track. To exit the screen without changing the station, touch the **iPod** icon in the upper right corner.

PANDORA RADIO OPERATION

Pandora Radio is available via your iPhone® (data usage will occur) or iPod® touch (Wi-Fi).







NOTE: For basic iPod®/iPhone® connectivity, you can use the white 30-pin to USB iPod cable that came with your Apple device. For iPod® video or photo playback, you must purchase the jLink-USB cable.

NOTE: The Pandora app must be installed on your iPhone®/iPod® touch.

Pandora Radio TFT Display

The on-screen indicators and touch key areas for Pandora Radio functions are outlined below.



1. **Pandora** icon: Touch to view the SOURCE MENU and select a new playback source.
2. Equalizer setting indicator: Displays the current equalizer preset setting.
3. **EQ**  icon: Touch for quick access to Equalizer level settings menu.
4. Clock: Displays the time as entered by the user in the settings menu.
5. Pandora Preview Window: Displays album art, if available.
6. **iPod** icon: Touch to return to the iPod® mode of operation.
7. **Book Mark** icon: Touch to display the Add BookMark submenu to bookmark a track or artist.
8.  Thumbs Up Icon: Press this icon to tell Pandora “you like this track” and bring in more tracks like it to your station.
9.  **Thumbs Down Icon:** Press this icon to tell Pandora to not play this track. Pandora will skip to the next track. If the skip limit has been reached, Pandora will continue to play but your feedback will be recorded.
10.  (Next) Icon: Press this icon skip a song, subject to the skip limit.
11.  (Pause / Play) icon: Touch the  icon to pause playback. Touch the  icon to begin playback.

12. **Station List** icon: Press this icon to access the Station List Screen.
13. Elapsed Time indicator: Displays the elapsed and total playing time of the current track playing.
14. Playback Information Display: Displays station, track, artist, album, and elapsed time information.

Bookmark Submenu

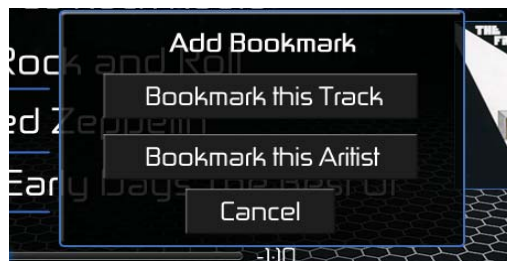

- Touch the **Bookmark this Track** icon to bookmark a track.
- Touch the **Bookmark this Artist** icon to bookmark an artist.
- Touch the **Cancel** icon to return to the Pandora Radio screen.

Station List Screen

The Station List Screen allows you to search for music by stations you created.

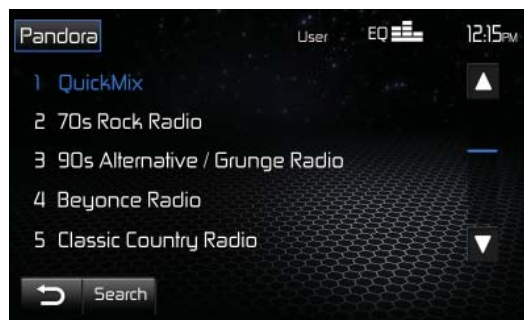

- Touch a station on the list to choose that station.
- Touch the Scroll Down (▼) icon to view the next page in the list or the Scroll Up (▲) icon to view the previous page.

To Launch/Stop Pandora Radio

1. Launch the Pandora app on your iPhone®. The Pandora icon appears on the Main Menu Screen.



2. Touch the Pandora icon. The Pandora Screen appears.



3. Touch the ► icon to begin playback or the || icon to pause playback.
4. Touch the iPod icon to exit Pandora and go to the iPod Search Menu.

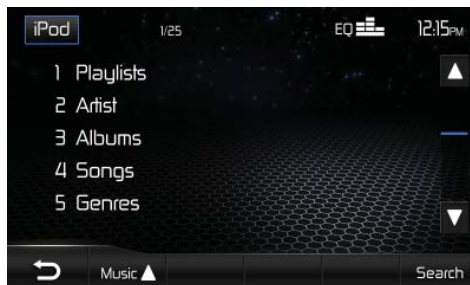



VM9725BT

Pandora Error Messages		
Message Displayed	Cause	Corrective Action
BookMark Track Error	Software Error	The track could not be bookmarked, please try again in a moment.
BookMark Artist Error	Software Error	The song could not be bookmarked, please try again in a moment.
Thumbs Up / Down Error "Error Track Rating"	Software Error	Song feedback could not be sent, please try again in a moment.
No Active Station Error	Software Error	This account has no stations in it. Please visit Pandora.com and login to your account and add stations.
Skip Limit Reached	Software Error	Please note that Pandora limits skips to a maximum of six skips per station, per hour.



BLUETOOTH OPERATION

Bluetooth® was launched by a special interest group (SIG) comprised of Ericsson Inc., Intel Corp., Nokia Corp., Toshiba and IBM in 1998, and it is currently developed by nearly 2,000 companies worldwide. The Bluetooth® word mark and logos are owned by the Bluetooth SIG, Inc. and any use of such marks by Audiovox Corporation is under license. Other trademarks and trade names are those of their respective owners.

Bluetooth® technology has the capability to wirelessly synchronize and transfer data among devices. The Bluetooth® audio capabilities can be used for mobile phones hands free applications. Bluetooth® has many profiles and the unit is compatible with most Bluetooth® enabled mobile phones. Before attempting to use the Bluetooth® functions on the unit, please make sure your mobile phone supports Bluetooth® functions.

NOTE: The line-of-sight distance between this unit and your mobile phone must be 8 feet (2.4 meters) or less for sending and receiving voice and data via Bluetooth® wireless technology.

Please make sure your mobile phone supports Bluetooth® functions (Headset or Handsfree profiles or both). Adhere to the following guidelines for successful operation.



- Before using Bluetooth® functions, you must pair your mobile phone to the VM9725BT head unit (see "Pairing the Bluetooth® System with Your Mobile Phone and Head Unit"). To ensure the best reception for pairing and re-connection, please make sure the mobile phone battery is fully charged before you begin.
- Try to perform pairing within a few minutes of the mobile phone being turned on.
- Once the unit has been paired with the mobile phone, the unit's model number, "VM9725BT", will be displayed on the mobile phone.
- To achieve the best performance, always keep the mobile phone within 3 meters of the head unit.
- Always keep a clear path between the mobile phone and the head unit. Never place a metal object or any other obstacle between the mobile phone and the head unit.
- Some mobile phones (like Sony Ericsson) may have a "Power Saving Mode" option. PLEASE DO NOT use the power saving mode with the VM9725BT.
- Before accepting or making a call, make sure your mobile phone's "Bluetooth® function" is turned on.
- To ensure the best conversation quality/performance, stay within one meter of the microphone when talking.
- To manually disconnect the mobile phone from the head unit, press the "Chain Link" icon on the Bluetooth® user interface (next to the mobile phone name) and the Bluetooth® will be "disconnected", but still paired.



Bluetooth User Interface

The on-screen indicators and touch key areas for Bluetooth® functions are outlined below.



1. **BT** icon: Touch to view the SOURCE MENU and select a new playback source.
2. **HTC Desire Z** indicator: Name of the connected device.
3. Clock: Displays the time as entered by the user in the settings menu.
4. **Missed Call** icon: Touch to access the missed calls list.
5. **Received Call** icon: Touch to access the received calls list.
6. **Dialed Call** icon: Touch to access the dialed calls list.
7. **Options** icon: Touch to configure Bluetooth® parameters and options.
8. **Call History** icon: The call history consists of dialed numbers, received calls, and missed calls.
9. **Direct Entry** icon: Touch to access the Direct Entry Screen.
10. **Phone Book** icon: Touch to access the contacts list.
11. **BT Audio** icon: Touch to access the Bluetooth® music function.
12. : Indicates whether the unit is disconnected/connected with a Bluetooth® device.
13. Keypad: Touch 0-9, *, # to enter the phone number you wish to dial. Once the correct number appears on the screen touch the  icon. If you enter an incorrect number, touch the red **X** icon to delete the incorrect number.

Hands Free Profile (HFP)

To use a mobile phone with this unit, it is necessary to first establish a connection using Bluetooth® wireless technology. The connection is normally established using Hands Free Profile (HFP), which gives you full control of functions available on the mobile phone source. However, depending on your mobile phone, the connection may be made using Head Set Profile (HSP), making some functions unavailable. This is a limitation of your mobile phone, not the VM9725BT.

Since there are a number of Bluetooth® mobile phone implementations available on the market, operations with your Bluetooth® mobile phone using this unit vary greatly.

Please refer to the instruction manual that came with your Bluetooth® mobile phone along with this manual while operating your mobile phone with this unit.

Pairing the Your Mobile Phone with the Head Unit

Your mobile phone can initiate a search for new devices and pair to the unit. The following paragraphs describes the pairing process.

NOTE: The following procedures are generic. Procedures for pairing mobile phones may vary slightly from mobile phone manufacturer to mobile phone manufacturer.

1. Press the **SRC** button on the front panel to access the Source Menu.
2. Touch the **BT** (Bluetooth) icon. The following screen will appear:

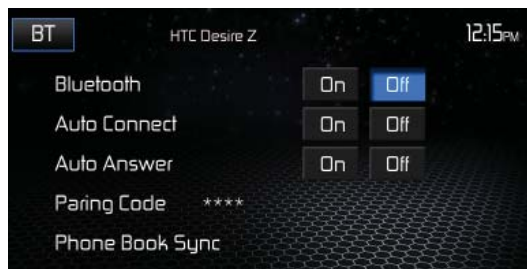

3. Set the **Bluetooth** function to ON.
4. Set the **Auto Connect** function to ON.
5. Access the mobile phone Bluetooth® function and set the function to ON.
6. Set the mobile phone Bluetooth® discover mode to ON.

NOTE: Some discovery modes have a time limit usually a minute before they are automatically turned off.

7. Use the mobile phone's add a new device feature. A device or devices will appear on your mobile phone display.



VM9725BT

8. A prompt to pair or bond should appear on your mobile phone. Accept the request and initiate the process.

NOTE: Some mobile phones require a "pass key" or pairing code to connect. If your phone requires a pass key or pairing code, you will need to enter this number. The default pairing code for many mobile phones is "0000". The default code for the unit is "1234".

9. A prompt to enter a PIN number or passkey for the unit should appear. The default passkey for the unit is "1234".
10. At this point a prompt stating pairing successful should appear. Another prompt should appear asking connect to the unit, Yes or No. Press Yes. The mobile phone and the unit should connect. The mobile phone should display a message similar to "Device Connected" and the mobile phone and the unit are now connected. VM9725BT will appear on the mobile phone list of devices.

Managing Incoming Calls

When connected to a Bluetooth® mobile phone, the unit will mute audio output, pause CD play, and change to the Bluetooth® screen below when a call is received. The incoming phone number or assigned name for that number will appear in the middle of the screen. An audible tone will sound from the unit and a graphic display will appear on the front panel.

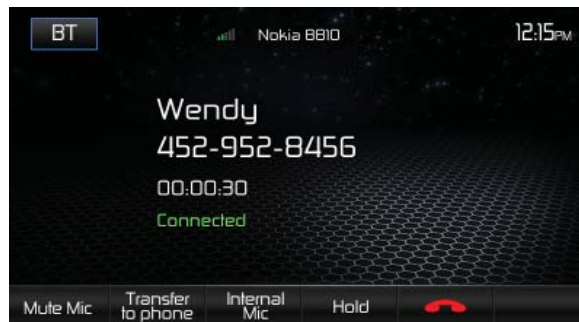



1. **Mute Mic** icon: Touch to mute the microphone audio from the unit. Touch the icon again to restore the microphone and audio from the unit.
2. **Transfer to Phone** icon: Touch to transfer a call back to the mobile phone.
3. **Internal Mic / External Mic** icon: Touch to toggle between the internal microphone and an external microphone.
4. **Mute Mic** icon: Touch to mute the microphone audio from the unit. Touch the icon again to restore the microphone and audio from the unit.
5. **Hold** icon: Touch to place a call on hold.
6.  icon: Touch to end an incoming call.

VM9725BT



Answering an Incoming Call

To answer an incoming call touch the  icon. For best reception, speak loudly and clearly into the microphone. To end the conversation, touch the  icon.

Rejecting an Incoming Call

Press the **Transfer to Phone** icon to reject an incoming call. The call will revert to your mobile phone and be left for voice mail.

Volume Control

To increase or decrease the volume level of an incoming call, turn the rotary knob on the front panel or press the **VOL +/-** buttons on the remote control.

Audio Mute

To mute the phone call audio from the unit when a call is received, press the front panel rotary knob. Press the front panel rotary knob again and phone call audio will be restored to the unit.



Making an Outgoing Call

Outgoing calls can be performed by direct dialing using the unit's touch screen keypad. The keypad screen is accessed by touching the **Direct Entry** icon .

Direct Dialing

1. Touch the **Direct Entry** icon and the following screen will appear:



2. Using the keypad, touch 0-9,*, # to enter the phone number you wish to dial. If you enter an incorrect number touch the red **X** icon on the keypad to delete the incorrect number.
3. Once the correct number appears on the screen touch the  icon. To exit the direct entry screen touch the **X** icon in the upper right corner of the screen.
4. To end the call touch the  icon on the previous screen.



VM9725BT

Call Transfer

While talking, to transfer audio from the unit back to the mobile phone, touch the **Transfer to Phone** icon and the following screen will appear:

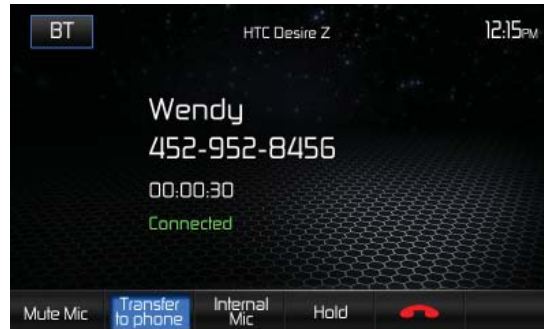

Pressing the **Transfer to Phone** icon again will return the audio from the mobile phone to the unit.

Missed Calls

The missed calls list retrieves the list of missed numbers from your mobile phone if your mobile phone allows the function. The last missed number is the first number on the list.



To make a call from the missed calls list, touch the call's name and it will be dialed.

VM9725BT



Received Calls

The received calls list retrieves the list of numbers from your mobile phone if your mobile phone allows the function. The last received number is the first number on the list.

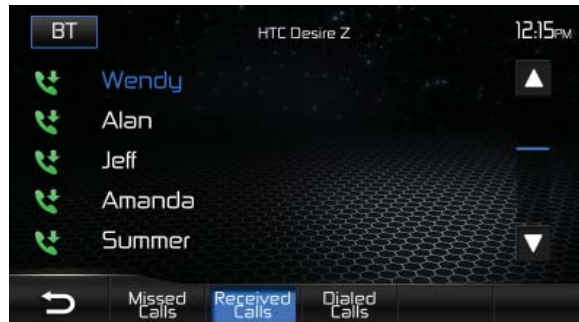

To make a call from the received calls list, touch the call's name and it will be dialed.

Dialed Calls

The dialed calls list retrieves the list of dialed numbers from your mobile phone if your mobile phone allows the function. The last dialed number is the first number on the list.



To make a call from the dialed calls list, touch the call's name and it will be dialed.



VM9725BT

Phone Book

The phone book is a copy of the contact list on your mobile phone which contains a listing of your important names and phone numbers. Touch the ▲ or ▼ icon to scroll up or down the contact list page.



To make a call from the phone book, touch the contact's name. Touch the ☎ icon on the next screen and it will be dialed.

Bluetooth Music Function

Bluetooth® provides an Advanced Audio Distribution Profile (A2DP) profile for streaming music from a mobile phone or a portable multimedia player (PMP), sometimes referred to as a MP3 player. The unit allows you to play back audio files from your mobile phone or a PMP using a Bluetooth® connection.

NOTE: Please quit A2DP mode before attempting to make a phone call, as unexpected results may occur depending on your mobile phone model.

The unit can control a Bluetooth® audio player via Advanced Audio Distribution Profile (A2DP) or Audio/Video Remote Control Profile (AVRCP). Bluetooth® audio players (or Bluetooth® adapters) compatible with these profiles can be connected to this unit. Touch the **BT Audio** icon and the following screen will appear:



While listening to audio the following functions are available:

1. Pause/Play (▶||) icon: Touch to pause playback. Touch again to resume playback.
2. Previous (◀◀) icon: Touch to play the previous track.
3. Next (▶▶) icon: Touch to play the next track.

Functionality varies depending on the profile used:

- A2DP: Stream audio from your Bluetooth® compatible audio player and listen to the music through the unit.
- AVRCP: Play back, pause, select songs, etc. while streaming audio from your Bluetooth® compatible audio player to the unit.

NOTE: Song information (e.g. elapsed playing time, song title, song index, etc.) cannot be displayed on this unit. Since there are a number of Bluetooth® audio players available on the market, operations with your Bluetooth® audio player while using this unit may vary greatly. Please refer to the instruction manual that came with your Bluetooth® audio player.

When there is an incoming call, the song will be paused. After the incoming call is finished, the screen will return to the music function screen and playback will continue.



VM9725BT

SiriusXM® RADIO OPERATION

Everything worth listening to is on SiriusXM®, getting over 130 channels, including the most commercial-free music, plus the best sports, news, talk and entertainment. A Vehicle Tuner (sold separately) and subscription are required. For more information, visit www.siriusxm.com.

Sirius, XM and all related marks and logos are trademarks of SiriusXM® Radio Inc. and its subsidiaries. All other marks and logos are the property of their respective owners. All rights reserved.

Activating SiriusXM® Radio

Satellite Radio operation requires the connection of an optional Vehicle Tuner and antenna (sold separately). To connect the Vehicle Tuner, follow the instructions provided with the tuner.

To listen to Satellite Radio, a subscription is required.

Activate the Vehicle Tuner using one of the two methods below:

- Online: Go to www.siriusxm.com and choose ACTIVATE RADIO.
- Phone: Call 1-866-635-2349.

Activation typically takes 10 -15 minutes, but may take up to an hour. It is recommended to leave your vehicle on until the "Subscription Updated" message appears.

Retrieving the Radio ID Code

The Satellite Radio Subscription requires that the Radio ID be retrieved. To display the Radio ID:

1. Touch the **Direct** icon. The Direct Entry Menu appears.
2. Enter channel "0" using the on-screen number pad then press the **ok** icon. The SiriusXM® User Interface tuner screen displays the ID where the artist name is displayed.

VM9725BT



SiriusXM® User Interface

The on-screen indicators and touch key areas for SiriusXM® functions are outlined below.

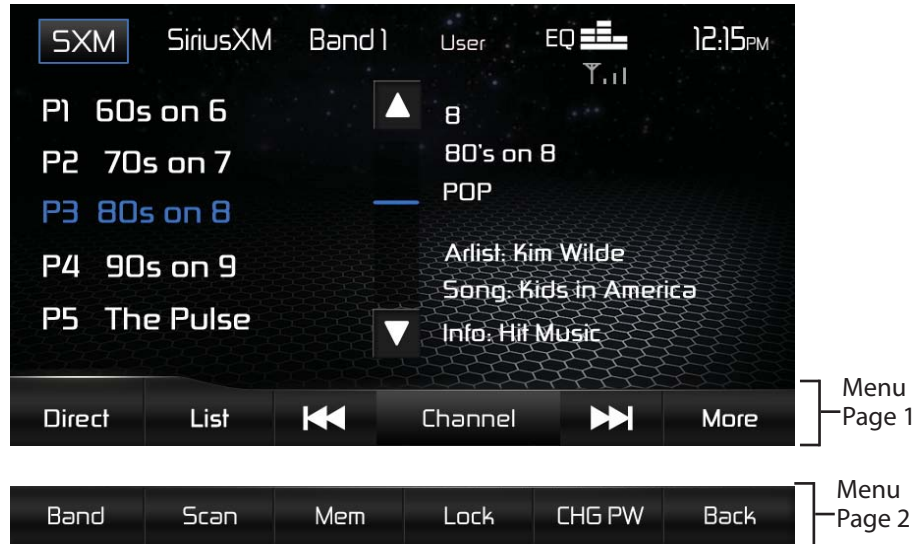

Menu Page 1

1. **SXM** icon: Touch to view the SOURCE MENU and select a new playback source.
2. Band indicator - Displays SiriusXM® radio band currently selected.
3. Equalizer setting indicator: Displays the current equalizer preset setting.
4. **EQ** : Touch for quick access to the Equalizer level settings menu.
5. Signal Strength indicator : As the strength of the satellite radio signal increases, the number of illuminated segments will increase.
6. Clock: Displays the time as entered by the user in the settings menu.
7. Program Information:
 - Channel Number: Channel numbers are used to designate the channel along with the channel name and are useful for identifying/loading a channel via the "direct entry" method.
 - Channel Name: The channel name is used to identify the channel and is usually related to that channel's musical content.
 - Category Name: A category may contain one or more channels grouped by their similar content into a "Category".
 - Artist Name: This area displays the name of the artist currently playing.
 - Song: This area displays the name of the song currently playing.
 - Info: Contains additional information related to the song/track now playing.
8. **More** icon: Touch to go to Menu Page 2.



VM9725BT

9. Next (▶▶) icon: Touch to tune to the next channel.
10. **Category/Channel** icon: Touch to toggle the icon displayed between Category and Channel.
11. Previous (◀◀) icon: Touch to tune to the previous channel.
12. **List** icon: When the Category icon is displayed, touch List to go to the Category Screen. When the Channel icon is displayed, touch List to go to the Channel Screen.
13. **Direct** icon: Touch to display the Direct Entry Menu.
14. Channel Preset icons: A preset is a channel name that is stored for instant access to that channel. Touch a preset icon to select the corresponding stored channel.

Menu Page 2

15. **Back** icon: Touch to go to Menu Page 1.
16. **CHG PW** icon: Touch to go to the change password screen.
17. **Mem** icon: Touch to display screen used to enter current channel into preset memory.
18. **Scan** icon: Touch to scan to the next available channel. The tuner will pause for approximately five seconds at that channel. Touch scan again to listen to that channel. If scan is not touched, the tuner will automatically seek the next channel.
19. **Band** icon: Ten preset channels will display at a time. Touch this icon to display the next band of preset channels. Three bands are available: Band 1, Band 2, and Band 3.

VM9725BT



Switching to SiriusXM® Radio

- Touch the top left corner of the screen (the radio box) to view the Source Menu. Touch the **SiriusXM** icon.
- Press the **SRC** button on the front panel to switch to the SXM source.

Selecting the SiriusXM® Band

Touch the **Band** icon on the screen to change between the following bands: Band1, Band2, and Band3.

Seek Tuning

- To seek the next higher channel, touch the **▶▶** icon.
- To seek the next lower channel, touch the **◀◀** icon.

Direct Tuning

To enter a SiriusXM® radio channel directly:

1. On the SiriusXM® menu page 1, touch the **Direct** icon to display the Direct Entry Menu.



2. Enter the desired SiriusXM® radio channel using the on-screen number pad then press the **ok** icon. If you wish to delete an entry number touch the red **X** icon.
3. To exit the screen without changing the channel, touch the **➤** icon.



Using Preset Stations

Ten numbered preset buttons store and recall channels for each band. All ten stored channels for the current band appear on the screen.

Storing a Channel

1. Select a band (if needed), then select a channel.
2. On the SiriusXM® menu page 2, touch the **Mem** icon to access the Preset Screen.



3. Touch the preset number (P1 through P10) in which you would like to store the current channel (or touch the **X** icon to cancel and close the menu). The channel will be stored in that preset and displayed on the SiriusXM® User Interface tuner screen.

Recalling a Channel

1. Select a band (if needed).
2. Touch a channel on the preset channel list to select the corresponding stored channel. Touch the ▲ or ▼ icon to scroll up or down the list.

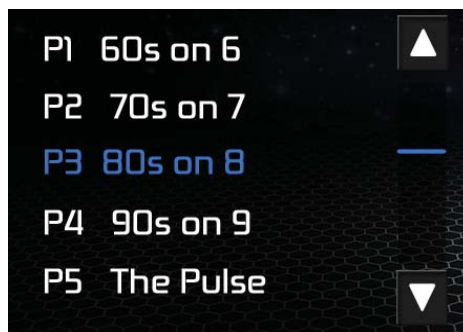

Searching for a Channel

Search by Channel

To search by channel:

1. On the SiriusXM® menu page 1, touch the **Category/Channel** icon (if needed) to select **Channel**.
2. Touch **List** to display the Channel Screen:



3. Touch a channel to tune to that channel.

Search by Category

Categories group music by type such as jazz, rock, classical, etc. To search by category:

1. On the SiriusXM® menu page 1, touch the **Category/Channel** icon (if needed) to select **Category**.
2. Touch **List** to display the Category Screen:



3. Touch a category item. A channel list screen appears.
4. Touch a channel to tune to that channel.



SXM Mature Channel Lock

SiriusXM® attaches a label to channels with adult content. The radio recognizes these channels as “Mature”. The Mature Channel Lock option allows you to lock out channels with “Mature” labels. These channels will still appear in the channel listing (with a lock symbol), but will not be tunable unless the parental lockout password is correctly entered.

Lock Mature Channels

To lock mature channels:

1. On the SiriusXM® menu page 2, touch the **Lock** icon. The following screen appears:



2. Enter your 4-digit password and then press the **ok** icon. The following screen appears:



3. Touch the **Lock Mature** icon. The mature channels are now locked.

Temporarily Unlock a Mature Channel

When the global "Mature Lock" is enabled, a mature channel can be temporarily unlocked until the channel is changed. This mode is useful for listening to mature/adult content on a temporary basis, allowing you to listen on a locked channel without having to disable the global "Mature Lock."

To temporarily unlock a mature channel:

1. Tune to a mature channel. If the channel is locked, **Chan Locked** will appear on the SiriusXM® User Interface tuner screen. Enter the password to unlock the channel to tune it.
2. On the SiriusXM® menu page 2, touch the **Lock** icon. The following screen appears:

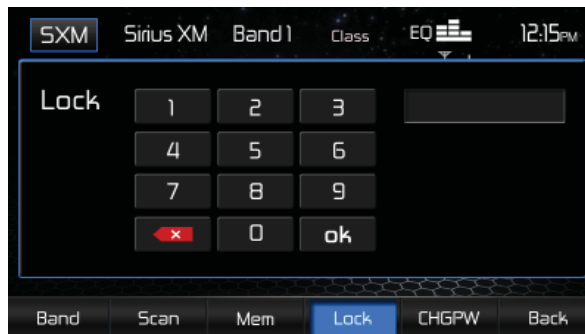

3. Enter your 4-digit password and then press the **ok** icon. The following screen appears:



4. Touch a lock icon to unlock a channel. Touch the ▲ or ▼ icon to scroll up or down the list. For example, channels 2 and 5 are locked, and channels 1, 3, and 4 are unlocked.



Unlock All Mature Channels

To unlock all mature channels:

1. On the SiriusXM® menu page 2, touch the **Lock** icon. The following screen appears:

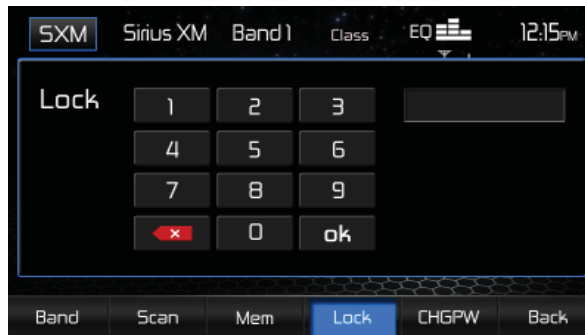

2. Enter your 4-digit password and then press the **ok** icon. The following screen appears:



3. Touch the **Unlock ALL** icon. All channels are now unlocked.

VM9725BT



Change Lock Password

The Change Lock Password option allows you to change the password from the default or current custom password to another password.

NOTE: The default password is 0, 0, 0, 0.

To change a password:

1. Touch the **CHGPW** icon. The following screen appears:



2. Enter your 4-digit password and press the **ok** icon.
3. Enter the new 4-digit password and press the **ok** icon. The new password is set.



VM9725BT

SiriusXM® Radio Advisory Messages

SiriusXM® user advisory messages are listed below:

Advisory Displayed	Cause
Check SXM Tuner	Check the SiriusXM® tuner connection on the back of the unit to ensure that it's correctly connected.
Check SXM Antenna	Ensure the SiriusXM® antenna cable is connected to the SiriusXM® tuner correctly. Check the SiriusXM® antenna wire for breaks or sharp bends. Replace the antenna if necessary. If the message remains, the antenna may have been damaged.
No SXM Signal	The vehicle must be outside, and the antenna must have a clear view of the southern sky. The magnetic antenna must be mounted on the outside of the vehicle for the best reception.
Channel Not Subscribed	This channel is not included in your SiriusXM® subscription plan. Call 1-866-635-2349 to subscribe.
Channel Not Available	This channel is not a valid SiriusXM® channel. The channel number has been entered incorrectly, or the channel was removed from the SiriusXM® channel lineup.
Channel Locked	The selected channel has been locked by the parental controls, or a mature channel has been selected. A prompt to enter the unlock code will appear. Enter the unlock code.

VM9725BT



REAR CAMERA OPERATION

This unit is "camera ready." Before accessing any camera features, you must install a rear video camera.

When the camera is not installed and the function is accessed by the gear selector being placed in reverse or by the unit's menu, the message "VIDEO NOT DETECTED" will appear, indicating the function is not available.

When the camera is installed, the rear view image of what is behind the vehicle will appear when the vehicle is placed in reverse gear. When leaving reverse gear, the unit displays the previous screen.

The rear camera image can be adjusted from Normal to Mirror using the "Setup" menu ("see Video Sub-menu Features").



TROUBLESHOOTING

Table 6: Troubleshooting

Problem	Cause	Corrective Action
GENERAL		
Unit will not power on	Radio Fuse blown	Install a new fuse with the correct rating
	Car battery fuse blown	Install a new fuse with the correct rating
	Illegal operation	Press the RESET button located over the rotary encoder on the front panel
No/low audio output	Improper audio output connection	Check wiring and correct
	Volume set too low	Increase volume level
	Improper "MUTE" connection	Review wiring diagram and check "MUTE" connection
	Speakers damaged	Replace speakers
	Heavily biased volume balance	Adjust the channel balance to the center position
	Speaker wiring is in contact with metal part of car	Insulate all speaker wiring connections
Poor sound quality or distortion	Pirated disc is in use	Use original copy
	Speaker power rating not compatible with unit	Connect proper speakers
	Speaker is shorted	Check speaker contact
Unit resets itself when engine is off	Incorrect connection between ACC and positive battery wire	Check wiring and correct

VM9725BT



Problem	Cause	Corrective Action
TFT Monitor		
No image	Incorrect connection to parking brake wire	Check wiring and correct
	Parking brake is not engaged	Stop vehicle in safe place and apply parking brake
Flashing image or interference appears on screen	DVD is not compatible with current TV system settings	Change setup to accommodate disc
	Improper video signal connections	Check wiring and correct
Prolonged image or improper height/width ratio display	Improper aspect ratio setup	Use correct aspect ratio setting
TUNER		
Weak station searching	Auto antenna is not fully extended	Connect the auto antenna control cable properly
	Auto antenna not properly connected	Connect the auto antenna control cable properly
	LOCAL function is activated	Turn LOCAL function off
DISC		
Cannot insert disc	Disc already inside unit	Eject current disc and insert new one
Image blurred, distorted or dark	Disc is illegally copied	Use original disc



VM9725BT

Problem	Cause	Corrective Action
Disc does not play back	Disc is warped or scratched	Use disc in good condition
	Disc is dirty or wet	Clean disc with soft cloth
	Laser pickup is dirty	Clean laser pickup with cleaning disc
	Incompatible disc is used	Use compatible disc
	Disc rating exceeds Parental Lock rating limit	Change Parental Lock settings to lower restriction
	Disc region code is not compatible with unit	Use disc with proper region code
	Disc is inserted upside down	Insert disc with label side up
PBC cannot be used during VCD playback	PBC is not available on the disc	
No repeat or searching while playing VCD	PBC is on	Turn PBC off
MP3		
Interruption occurred during playback	Disc is dirty or scratched	Clean disc or replace
	File is damaged/bad recording	Recreate disc with good files



Disc Error Messages

Message Displayed	Cause	Corrective Action
Loading	Disc is being read	
No Disc	Disc is dirty	Clean disc with soft cloth
	Disc is upside down	Insert disc with label side up
	Disc not present in loading compartment	Insert disc
Bad Disc	Disc is dirty	Clean disc with soft cloth
	Disc is upside down	Insert disc with label side up
Unknown disc	Disc format is not compatible with this unit	Use compatible disc
Region Error	DVD is not compatible with region code of unit	Use disc with proper region code
Error	Illegal mechanism operation	Press EJECT key for 5 seconds to reset loading mechanism



VM9725BT

Care and Maintenance

1. Use only a clean silicone cloth and neutral detergent to clean the front panel or monitor. A rough cloth and non-neutral detergent (such as alcohol) may result in scratching or discoloration.
2. Do not get water or cleaning fluids on the unit.
3. If the temperature inside the player gets too hot, a protective circuit automatically stops play of the disc. If this occurs, allow the unit to cool before operating the player again.
4. Never insert anything other than a 5" (12 cm) compact disc into the player as the mechanism can be damaged by foreign objects.
5. Do not attempt to use a 3" (8 cm) CD-Single disc in this unit, either with or without an adaptor, as damage to the player and/or disc may occur. Such damage is not covered by the Warranty on this product.
6. The CD player may not operate properly in extreme hot or cold. If such conditions occur, allow the interior of the vehicle to reach a normal temperature before using player.
7. When the vehicle warms up during cold weather or under damp conditions, condensation may appear on the LCD panel. Should this occur, the screen will not operate properly until the moisture has evaporated.
8. We suggest you use a cleaning disc in this unit more frequently than in the unit in your home due to the environmental conditions of the vehicle.

VM9725BT



SPECIFICATIONS

DVD/CD Player

Compatible Disc Media: DVD + R / RW (Single and Dual Layer) and CD-R / RW
Compatible Media Formats: CD-DA, MP3, WMA, VCD, SVCD, Xvid, AVI, MPEG 1/2
Signal to Noise Ratio: >95dBA
Dynamic Range: >95dB
Frequency Response: 20Hz to 20 kHz, -3dB
Channel Separation: > 60dB @ 1 kHz
D/A Converter: High performance 24-bit / 192 kHz sample rate, Multi-Bit Sigma-Delta Modulator

Video

Format: NTSC, PAL (auto-detection)
Output: 1Vp-p (75-ohm)
Input: 1Vp-p (75-ohm)

FM Tuner

Tuning Range: 87.5MHz - 107.9MHz
Mono Sensitivity (-30dB): 9dBf
Quieting Sensitivity (-50dB): 15dBf
Alternate Channel Selectivity: 70dB
Signal to Noise Ratio @ 1 kHz: 58dB
Image Rejection: 80dB
Stereo Separation @ 1 kHz: >30dB
Frequency Response: 30Hz - 15 kHz, -3d

AM Tuner

Tuning Range: 530 kHz - 1720 kHz
Sensitivity (-20dB): 15uV
Signal to Noise Ratio @ 1 kHz: 50dB
Image Rejection: 60dB
Frequency Response: 50Hz - 2 kHz, -3dB

Monitor

Screen Size: 6.2" (Measured diagonally), 16:9 Widescreen
Screen Type: TFT Liquid Crystal Display (LCD) active matrix
Resolution: 1,152,000 sub pixels, 800x3 (W) X 480 (H)



VM9725BT

General

Auxiliary Input impedance: 10k

Power Supply: 11 to 16VDC, negative ground

Power Antenna (Blue): 500mA max, current limited protection

Amplifier Remote (Blue/White): 500mA max, current limited protection

Operating Temperature: -20C ~ 65C

Fuse: 15-amp, mini ATO type

DIN chassis dimensions: 7" X 7" X 4" (178mm x 178mm x 100mm)

CEA Power Ratings



Power Output: 13 Watts RMS x 4 channels into 4-Ohms @ < 1% THD+N

Signal to Noise Ratio: 70dBA below reference (Reference: 1 Watt, 4-Ohms)

Frequency Response: 20 Hz - 20 kHz, -3dB. (Aux Input used as reference input)

Reference Supply Voltage: 14.4VDC

*Specifications subject to change without notice

VM9725BT



Common Replacement Parts

Owner's Manual and Install Manual	30613600
Wire Harness	30313600
Trim Rings (Main and Secondary-Packaged Together)	30413590
External Microphone	30443240
Remote Control	30713600
Parking Wire	38213030
Sleeve and Mounting Brackets	30113270
Hardware Bag	30513270



Audiovox Electronics Corporation
Hauppauge, NY 11788
Technical Assistance: 1-800-323-4815
www.mobile.jensen.com
© 2012 Audiovox
Printed in China

128-9054a