



# VM9215BT

## Operating Instructions



**160** watts peak  
40W x 4



# VM9215BT

Thank you for choosing a Jensen product. We hope you will find the instructions in this owner's manual clear and easy to follow. If you take a few minutes to look through it, you'll learn how to use all the features of your new Jensen VM9215BT Mobile Multimedia Receiver for maximum enjoyment.

## CONTENTS

Features.....	3
Controls and Indicators.....	6
Remote Control.....	8
Using the TFT Monitor.....	14
Operating Instructions.....	16
Steering Wheel Controls .....	25
Settings Menu.....	26
Tuner Operation .....	34
DVD/VCD Video Operation .....	40
DVD/CD Audio Operation .....	46
MP3/WMA Operation .....	50
iPod®/iPhone® Operation.....	57
Pandora Operation.....	61
Bluetooth Operation .....	66
SiriusXM® Radio Operation.....	75
Rear Camera Operation.....	83
Troubleshooting .....	84
Care and Maintenance .....	88
Specifications.....	89
Common Replacement Parts .....	91

# VM9215BT



## FEATURES

Congratulations on your purchase of the Jensen VM9215BT Mobile Multimedia Receiver. It's a good idea to read all of the instructions before beginning the installation. We recommend having your Jensen VM9215BT installed by a reputable installation shop.

### DVD

- Aspect Ratio - Full and Normal
- Fast Forward - 2X, 4X, 8X, and 20X
- Slow Motion - 2X, 4X, 8X, and 20X
- Play, Pause, Stop, Next Chapter, and Previous Chapter

### CD / MP3 / WMA

- CD-Text Compatible
- ID3 Tag Compatible
- Directory Search (MP3 / WMA Only)
- Direct Track Access via Remote Control
- Burn up to 1500 MP3 and WMA Files onto a DVD+R / RW
- Audible Forward / Reverse Track Search (CD-DA Only)
- Random, Repeat, and Intro
- Play, Pause, Stop, Next Track, and Previous Track

### AM-FM

- USA / Europe / Latin America / Asia Frequency Spacing
- 30 Station Presets (18 FM / 12 AM)
- Auto Stereo / Mono
- Local / Distance
- Auto Store / Preview Scan

### iPod®/iPhone®

- iPod®/ iPhone® via USB
- High Speed Direct Connect Interface to Access iPod® Playlists, Artists, Albums and Songs. Play music and view video/photo\* files from your iPod®. \*Video/photo playback requires jLink-USB iPod® interface cable (sold separately).
- Power Management Charges iPod® while Connected



**VM9215BT**

### **SiriusXM® Ready**

- Satellite Channel Name, Artist, Song, and Categories Displayed on Monitor

### **Chassis**

- 1.0 DIN (Import / ISO-DIN Mountable)
- Motorized Flip-Out / Flip-Up LCD Screen
- 8 Character / Segment Type Secondary LCD Display
- 7" TFT Active Matrix LCD
- 336, 960 Sub Pixels (1440W X 234H)
- Screen Tilt / Angle Adjustment
- Beep Tone Confirmation (ON-OFF Option)
- Heat Management System - Forced Air-Cooling To Keep The Chip-Sets Operating at Nominal Temperatures

### **General**

- Navigation Ready (NAV104)
- Built-In Bluetooth with external microphone, providing hands-free operation for safety and convenience and A2DP for streaming music from your smartphone or other Bluetooth device.
- 44-Key Infrared Remote Control
- One Composite Video Output for Additional Screens
- Front Panel Audio/Video Input
- Three-Band Tone control (Bass, Mid and Treble) with Eight Preset EQ Curves  
Front Panel A/V Aux Input for Portable Media Devices
- Front, Rear, and Subwoofer Line Output
- Programmable Volume Control
- Rear Camera Input (Normal and Mirror Image View)
- Touch Screen Calibration Mode
- 4 VRMS Line Output - All Channels
- Rotary Encoder Audio Control
- SWC Interface - Compatible with PAC SWI-PS and Metra ASWC steering wheel control interfaces (sold separately)



## Optional Equipment

- **NAV104**

The VM9215BT is "navigation ready." Before accessing any navigation features, you must purchase and install the navigation module (NAV104). All installation and operating instructions will be included with the navigation module.

Once the navigation module is connected and operating properly, the NAV source mode will become active. While the navigation module is not installed, the NAV option appears gray, indicating the function is not available.

- **Bluetooth Phone**

See "Bluetooth Operation" on page 66.

- **Rear Camera**

The VM9215BT is "camera ready." Before accessing any camera features, you must purchase and install a rear video camera. Once the rear camera is connected and operating properly, the CAMERA source mode will become active. While the camera is not installed, the CAMERA option appears gray, indicating the function is not available.

**WARNING! Never install this unit where operation and viewing could interfere with safe driving conditions.**

**WARNING! To reduce the risk of a traffic accident (except when using for rear view video camera) never use the video display function while driving the vehicle. This is a violation of federal law.**

**WARNING! Never disassemble or adjust the unit.**

**WARNING! To prevent injury from shock or fire, never expose this unit to moisture or water.**

**WARNING! Never use irregular discs.**

**WARNING! To prevent damage to the mechanism inside this unit, avoid impact to the TFT monitor.**

**WARNING! The monitor employs an automatic motorized mechanism. To prevent damage to the core mechanism, please do not push, pull or swivel the monitor manually.**



VM9215BT

## CONTROLS AND INDICATORS

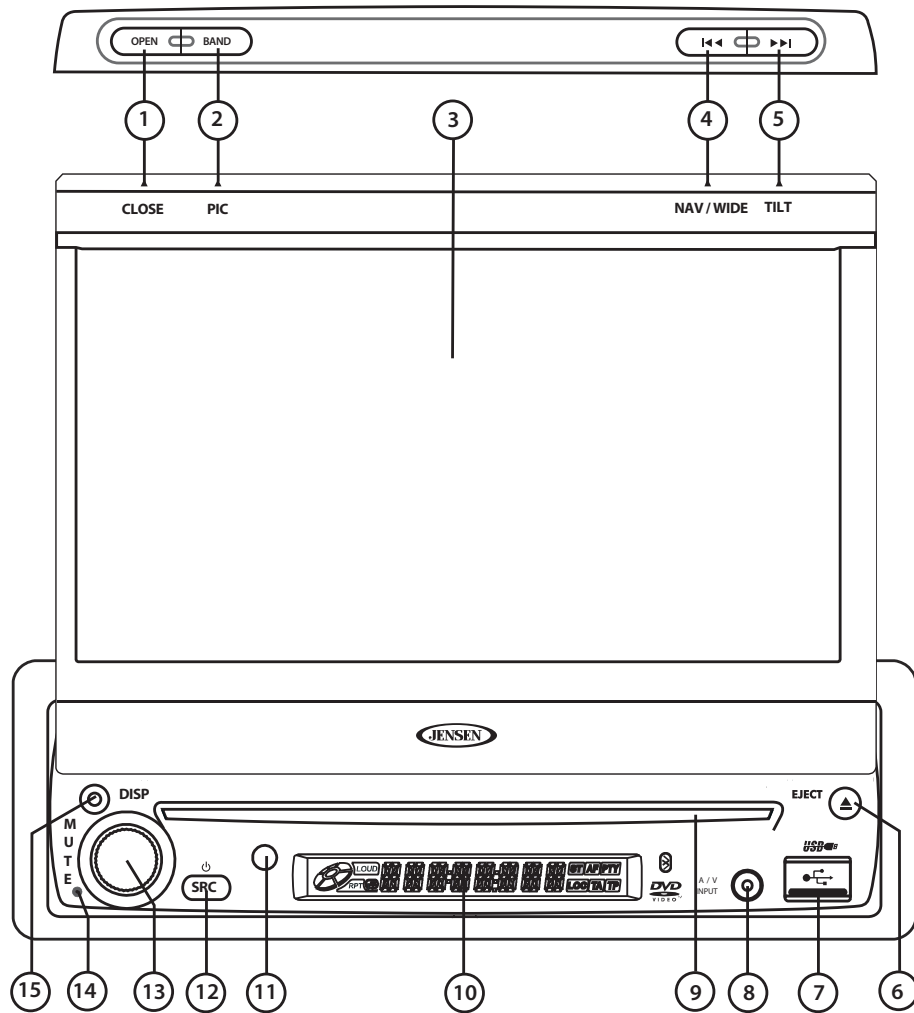

# VM9215BT



- 1. CLOSE/OPEN**  
Press to activate the automatic mechanical system and move the TFT monitor into the viewing position. Press again to close the TFT.
- 2. PIC/BAND**  
With the monitor open, press PIC to adjust the Brightness and Contrast (see "Image/Display Settings").  
With the monitor closed, press BAND to change between three FM and two AM bands.
- 3. TFT Display**
- 4. WIDE/◀◀**  
With the monitor open, press WIDE to adjust the display aspect of the picture to one of two settings: Full or STANDBY.  
With the monitor closed, press ◀◀ to seek backward.
- 5. TILT/▶▶**  
With the monitor open, press TILT to activate the tilt function. Use the rotary encoder to make adjustments while the blue tilt icon is flashing.  
With the monitor closed, press ▶▶ to seek forward.
- 6. EJECT**  
Press to eject a disc. Press and hold to reset the core mechanism position.
- 7. USB Interface Cover**  
Covers the USB interface connector. Open the cover and insert a USB device for playback of music/video files.
- 8. A/V Input**  
Attach a compatible A/V device.
- 9. DISC SLOT**
- 10. LCD Display**
- 11. IR Remote Control Receiver (Location)**
- 12. ⏻ / SRC**  
Press to turn the unit on. Once the unit is on, momentarily pressing the SRC button will display the Main Source Menu.  
Press and hold to turn the unit off.
- 13. Rotary Encoder**  
Rotate to adjust the volume. Press to activate the MUTE function and silence the receiver. Press again to resume sound.  
While in tuner mode, press and hold to activate the LOC feature. Repeat to deactivate.
- 14. RESET**  
Press to reset the system settings to factory default (except the password and parental lock setting).
- 15. DISP**  
With the monitor open, during DVD playback, press once to view Time, Title, Chapter info or twice for Audio, Subtitle, Angle, and Bit Rate info.  
With the monitor closed, press to view alternate LCD display information.



VM9215BT

## REMOTE CONTROL

See Table 1 for remote control functions.

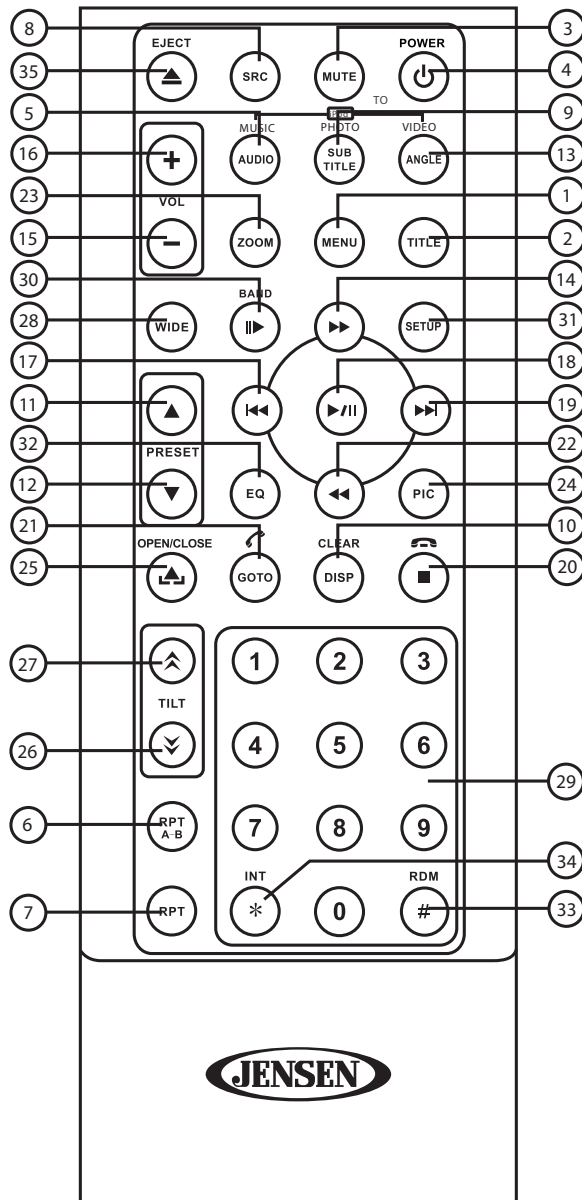





**Table 1: Remote Control Functions**

Button Name	Function					
	#	DVD	VCD	TUNER	CD/MP3/ USB	iPod
MENU	1	Enters the main menu of the disc.	Turns on/off PBC when playing VCD.		Selects Photo mode.	
TITLE	2	Enters the title menu of the disc.	Plays the first ten seconds of each chapter/ title.		Selects Music mode.	
MUTE	3	Toggles on/off audio output.	Toggles on/off audio output.	Toggles on/off audio output.	Toggles on/off audio output.	Toggles on/off audio output.
POWER ( ⏻ )	4	Turns the power on/off.	Turns the power on/off.	Turns the power on/off.	Turns the power on/off.	Turns the power on/off.
MUSIC/ AUDIO	5	Changes the audio language for disc playback.			Selects Music mode.	
REPT A-B	6	Setup to repeat playback from time frame A to time frame B.	Setup to repeat playback from time frame A to time frame B.			
REPT	7	Repeats playback of current chapter.	Repeats playback of current chapter.	Repeats playback of current track.	Repeats playback of current track.	
SRC	8	Selects playing mode.	Selects playing mode.	Selects playing mode.	Selects playing mode.	Selects playing mode.



# VM9215BT

**Table 1: Remote Control Functions**

Button Name	Function					
	#	DVD	VCD	TUNER	CD/MP3/USB	iPod
PHOTO/ SUBTITLE	9	Language selection for subtitle.				Selects Photo mode.
DISP/ CLEAR	10	Displays playing information.  Delete entry or move backwards to correct error in Direct Access mode.	Displays playing information.  Delete entry or move backwards to correct error in Direct Access mode.	Displays playing information.  Delete entry or move backwards to correct error in Direct Access mode.	Display playing information.  Delete entry or move backwards to correct error in Direct Access mode.	Displays playing information.  Delete entry or move backwards to correct error in Direct Access mode.
PRESET ▲	11			Navigates the preset station list.		
PRESET ▼	12			Navigates the preset station list.		
VIDEO/ ANGLE	13	Plays back disc in different angle for a scene.	Plays back Picture CD with different angle of picture displayed.			Selects Video mode.
▶▶	14	Fast forwards the disc content.	Fast forwards the disc content.		Fast forwards the disc content.	Accesses iPod Menu..
VOL -	15	Decreases volume.	Decreases volume.	Decreases volume.	Decreases volume.	Decreases volume.

**Table 1: Remote Control Functions**

Button Name	#	Function				
		DVD	VCD	TUNER	CD/MP3/ USB	iPod
VOL +	16	Increases volume.	Increases volume.	Increases volume.	Increases volume.	Increases volume.
⏮	17	Selects the previous chapter for playback.	Selects the previous chapter for playback.	Searches for an available radio station by decreasing tuning frequency.	Selects the previous track for playback.	Pauses playback/ starts playback.
▶/⏸	18	Pauses playback/ starts playback.	Pauses playback/ starts playback.		Pauses playback/ starts playback.	
▶/⏸	19	Selects the next chapter for playback.	Selects the next chapter for playback.	Searches an available radio station by increasing the tuning frequency.	Selects the next track for playback.	Selects the next track for playback.
■/⏹	20	Stops playback.	Stops playback.		Stops playback.	
GOTO	21	Open direct entry search screen.	Open direct entry search screen.			
⏪	22	Slow playback/ slow rewind playback.	Slow playback/ slow rewind playback.			
ZOOM	23	Zooms in/ out on an image.	Zooms in/ out on an image.			



## VM9215BT

**Table 1: Remote Control Functions**

Button Name	Function					
	#	DVD	VCD	TUNER	CD/MP3/ USB	iPod
PIC	24	Displays set-up parameters.	Displays set-up parameters.			
OPEN/ CLOSE (▲)	25	Opens/ closes the TFT monitor.	Opens/ closes the TFT monitor.	Opens/ closes the TFT monitor.	Opens/ closes the TFT monitor.	Opens/ Closes the TFT monitor.
TILT ▼	26	Decreases monitor tilt angle.	Decreases monitor tilt angle.	Decreases monitor tilt angle.	Decreases monitor tilt angle.	Decreases monitor tilt angle.
TILT ▲	27	Increases monitor tilt angle.	Increases monitor tilt angle.	Increases monitor tilt angle.	Increases monitor tilt angle.	Increases monitor tilt angle.
WIDE	28	Selects display mode: FULL or NORMAL.	Selects display mode: FULL or NORMAL.			
1, 2, 3, 4, 5, 6, 7, 8, 9, 0 (Numeric Keypad)	29	Directly accesses chapter.		1-6 selects preset for current band.	Directly accesses track.	
BAND (■▶)	30	Press repeatedly for slow motion forward/ backward.	Press repeatedly for slow motion forward/ backward.	Selects FM/AM band.		



**Table 1: Remote Control Functions**

Button	Function					
Name	#	DVD	VCD	TUNER	CD/MP3/ USB	iPod
SETUP	31	Displays Setup menu.	Displays Setup menu.	Displays Setup menu.	Displays Setup menu.	Displays Setup menu.
EQ	32	Accesses equalizer menu.	Accesses equalizer menu.	Accesses equalizer menu.	Accesses equalizer menu.	Accesses equalizer menu.
RDM /#	33	Plays all chapters in random order.			Plays all tracks in random order.	Plays all tracks in random order.
INT /*	34			Plays the first ten seconds of each track.		
EJECT (▲)	35	Ejects the disc.	Ejects the disc.	Ejects the disc.	Ejects the disc.	Ejects the disc.



## USING THE TFT MONITOR

### Opening/Closing the TFT Monitor

#### ***Open TFT Monitor***

Press the **OPEN** button on the front panel or press the  button on the remote control to activate the mechanism that moves the display panel into the viewing position.

#### ***Close TFT Monitor***

Press the **OPEN** button on the front panel or press the  button on the remote control to load the display panel back into the compartment.



### TFT Monitor Auto Open

- If "TFT Auto Open" is "on" when the unit is turned on, the monitor automatically moves to the viewing position.
- If "TFT Auto Open" is "off" when the unit is turned on, press the **OPEN** button on the front panel or press the  button on the remote control to move the monitor into the viewing position.
- If "TFT Auto Open" is set to "Manual", the TFT will not close when the key is turned off.



### Monitor Tilt Angle Adjustment

A known characteristic of LCD panels is the quality of the display in relationship to the viewing angle. The monitor angle can be adjusted for optimum viewing using one of the following methods:

#### ***Step-by-Step Angle Adjustment***

- Press the **TILT**  or **TILT**  button on the remote control to adjust the tilt angle of the screen one step at a time.
- Press the **TILT** button on the unit. While the blue tilt icon is flashing, turn the rotary encoder to adjust the screen angle.

#### ***Continuous Angle Adjustment***

Press and hold the **TILT**  or **TILT**  on the remote control to adjust the tilt angle in a continuous motion.



## Monitor Movement Mechanism

If an obstruction occurs in the monitor path, the following protective measures can be executed to prevent damage to the mechanism or monitor:

**Table 2: Monitor Protective Measures**

<b>Obstruction</b>	<b>Self Protection</b>	<b>OPEN Button Pressed</b>	<b>Power Reconnected</b>
Monitor loading out horizontally	Monitor is automatically loaded into unit	Monitor fully extended horizontally	Monitor is automatically loaded into unit
Monitor loading in horizontally	Unit stops at obstruction point	Monitor fully extended horizontally	Monitor is automatically loaded into unit
Monitor loading out vertically	Unit stops at obstruction point	Monitor swivels back to the unit	Monitor swivels back to the unit
Monitor loading in vertically	Unit stops at obstruction point	Monitor swivels back to the unit	Monitor swivels back to the unit

After the protective procedure is executed, normal operation is resumed by pressing the **OPEN** button or disconnecting and reconnecting the power.

## TFT Aspect Ratio

With the monitor open, press and hold the **WIDE** button on the monitor to adjust the aspect ratio as follows:

### FULL

The entire screen is extended horizontally to the aspect ratio of 16 to 9. The extension ratio is the same at any point.

### STANDBY

The screen becomes black. Touch the screen to resume.



**VM9215BT**

---

## **OPERATING INSTRUCTIONS**

### **Power On / Off**

Press the **⏻ /SRC** button on the front panel or press the **POWER/ ⏻** button on the remote control to turn the unit on. You can also turn on the unit by pressing the **OPEN** button and opening the TFT screen.

Press and hold the **⏻ /SRC** button on the front panel or press the **POWER/ ⏻** button on the remote control to power off the unit. The monitor is drawn back into the main compartment.

### **Audible Beep Confirmation**

An audible beep tone confirms each function selection. The Beep tone can be disabled through the Setup menu.

### **Mute/Line Mute**

Press the rotary encoder **MUTE** button on the front panel or the **MUTE** button on the remote control to mute the volume. The mute symbol is displayed on the TFT screen.

Press the rotary encoder button again to restore the volume. Adjusting the volume or using any of the audio setup features cancels the mute function.

If the "MUTE" wire is connected, audio output mutes when a telephone call is received by a mobile phone.

### **Playing Source Selection**

When the monitor is closed, press the **SRC** button on the front panel or the **SRC** button on the remote control to change between available audio playing sources in the following order: **RADIO, DISC, USB1, USB2, SIRUSXM, BT, NAV, AUX,** and **CAMERA**. The source is displayed on the LCD screen.



## Source Menu

You can also use the touch screen to change the source through the SOURCE MENU page. To access the SOURCE MENU, touch the top left corner of the screen or press the **SRC** button on the front panel.



Source Menu Page 1

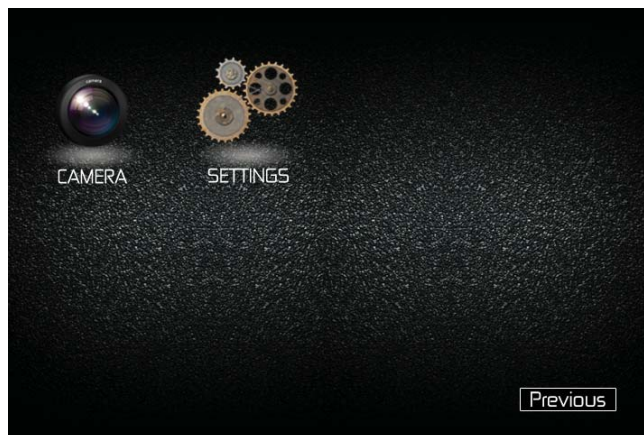

Source Menu Page 2

The SOURCE MENU consists of two pages. Touch the **Next** or **Previous** icons to go from one page to another. Touch the **DISC**, **RADIO**, **USB**, **USB2**, **SIRIUSXM**, **BT** (Bluetooth), **NAV**, **AUX IN**, **CAMERA** or **SETTINGS** icons to select the corresponding source.

**NOTE:** If an iPod® or iPhone® is attached to a USB port, "IPOD" appears instead of the text "USB."



## VM9215BT

### External Devices

External peripheral devices, including a game console, camcorder, navigation unit, iPod, Zune, etc. can be connected to this unit via RCA output using an A/V Media Adapter Cable (not included).

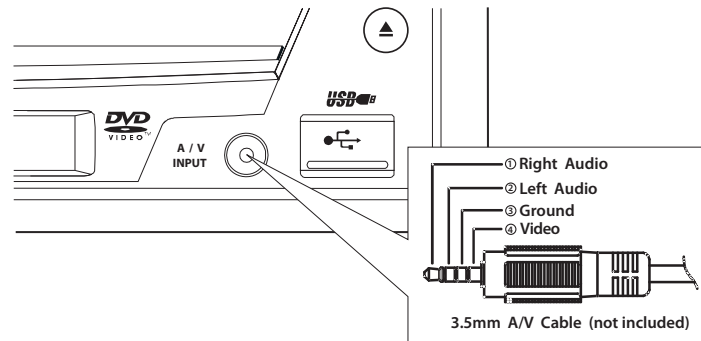

Connect the external device to the A/V Media Adapter Cable and then plug the cable into the A/V INPUT connector on the front of the radio. Select "AUX IN1" on the SOURCE MENU to access auxiliary devices. You cannot directly control external devices connected to the **A/V INPUT**.

For information regarding the use of USB devices, see "Inserting a USB Device."

### Volume Adjustment

#### Volume Increase/Decrease

To increase or decrease the volume level, turn the rotary encoder on the front panel or press the **VOL +/VOL -** buttons on the remote control. When the volume level reaches "0" or "40", a beep sounds, indicating that the adjustment limit has been reached. The LCD or TFT screen displays the volume level for 3 seconds.

#### Programmable Turn-On Volume

This feature allows the user to select a turn-on volume setting regardless of the volume setting prior to turning the unit off. To use this feature, the TFT monitor must be displayed.

To program a specific turn-on volume level, turn the rotary encoder to adjust the volume to the desired turn-on volume. Push and hold the rotary encoder while the blue speaker icon and level indication is displayed on the screen. The unit will beep to confirm your turn-on volume setting.

# VM9215BT



## Audio Control Menu

The Audio Control feature allows you to easily adjust your audio system to meet the acoustical characteristics of your vehicle, which vary depending on the type of vehicle and its measurements. Proper setting of the Fader and Balance boosts the effects of the cabin equalizer.

### Equalizer

Touch the EQ icon on the right side of the touch screen to display the equalizer screen or press the EQ button on the remote control.

- Use the touch screen +/- icons to adjust the settings for an audio feature.





Table 3. Equalizer Adjustments

Setting	Adjustable Range	Function
BASS	-14 to +14	Reduces or increases the bass frequency sound level. Touch the + or - buttons to adjust the settings.
MID	-14 to +14	Reduces or increases the mid-range frequency sound level. Touch the + or - buttons to adjust the settings.
TREBLE	-14 to +14	Reduces or increases the high frequency sound levels. Touch the + or - buttons to adjust the settings.
LCF	60 Hz	Selects the low pass filter center frequency. Touch the + or - buttons to adjust the settings.
	80 Hz	
	100 Hz	
	200 Hz	
MCF	0.5 kHz	Selects the mid pass filter center frequency. Touch the + or - buttons to adjust the settings.
	1 kHz	
	1.5 kHz	
	2.5 kHz	
TCF	10 kHz	Selects the high pass filter center frequency. Touch the + or - buttons to adjust the settings.
	12.5 kHz	
	15 kHz	
	17.5 kHz	
Equalizer Presets	User	Applies a preset sound level to the unit's audio output signal. Touch the ◀ or ▶ button to change the setting. <b>NOTE: The equalizer will automatically change to "USER" when individual audio functions are adjusted.</b>
	Acoustic	
	Urban	
	Rave	
	Latin	
	Dance	
	Hip Hop	
	Rock	

## VM9215BT

---



To exit the equalizer:

- touch the **X** button on the top left corner of the screen or press and hold the rotary encoder to return to the previous screen.
- touch the **BAL-FAD** button on the left side of the screen to display the balance/fader screen.



**Balance-Fader**

Touch the **BAL-FAD** button on the left side of the equalizer screen to display the balance/fader screen.

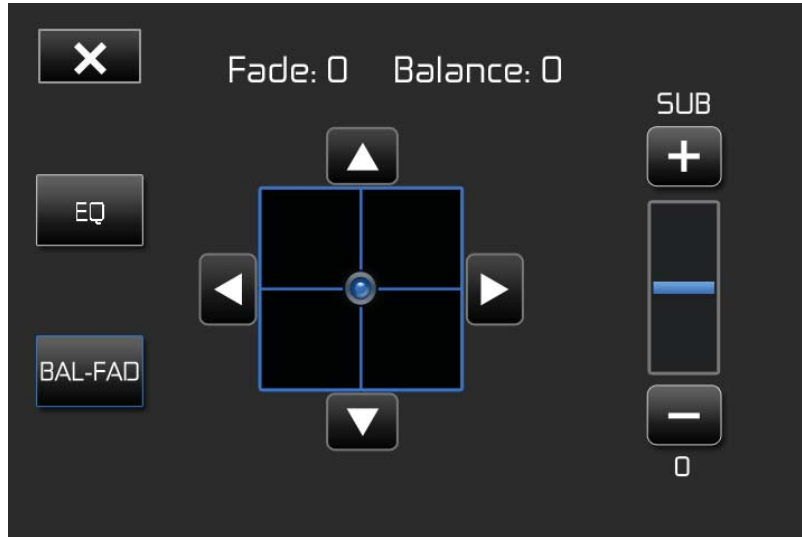

**Table 4. Balance-Fader Adjustments**

Setting	Adjustable Range	Function
Balance	-16 to +16	Balances the audio output levels between the left and right side of the vehicle. Touch the ◀ or ▶ button to change the setting.
Fade	-16 to +16	Balances the audio output levels between the front and back side of the vehicle. Touch the ▲ or ▼ button to change the setting.
Sub	-14 to +14	Reduces or increases the subwoofer sound level. Touch the + or - buttons to adjust the settings.

## VM9215BT

---



To exit the balance-fader:

- touch the **X** button on the top left corner of the screen.
- touch the **EQ** button on the left side of the screen to display the equalizer screen.



## VM9215BT

### System Reset

To correct a system halt or other illegal operation, use the tip of a pen to press the reset button located on the front bottom-right corner of the unit.

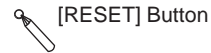

After a system reset, the unit restores all factory default settings.

**NOTE:** *If the unit is reset while a DVD is playing, the DVD resumes play once the reset is complete.*

### Image/Display Settings

#### Video Output Modes

Table 5 shows the video output mode for each playing source.

**Table 5: Video Output Modes**

Playing Source	Video Output Modes
AM/FM TUNER	YCbCr Mode
DVD	YCbCr Mode
AUX IN	CVBS Mode

\*CVBS – Composite Video Baseband Signal

#### Picture Adjustment

To adjust monitor display settings, perform the following steps:

1. Press the **PIC** button on the monitor to display the picture adjustment menu. The "BRIGHT" bar is highlighted in yellow.
2. Turn the rotary encoder to adjust the brightness setting level.
3. Press the **PIC** button again. The "CONTRAST" bar is highlighted in yellow.
4. Turn the rotary encoder to adjust the contrast setting level.
5. Press the **PIC** button again to exit the picture adjustment menu.

#### Parking Brake Inhibit

When the pink "Parking" wire is connected to the vehicle Parking Brake circuit, the front TFT monitor will display video when the Parking Brake is engaged. (When the pink wire is grounded via the Parking Brake circuit, video will be displayed.)



# VM9215BT



## **STEERING WHEEL CONTROLS (SWC) (if equipped)**

The VM9215BT is compatible with the PAC (Pacific Accessory Corporation) SWI-PS and Metra ASWC steering wheel control adapters. A 3.5mm female connector (labeled "SWC Interface") on the back of the head unit allows connectivity to the adapters. Please refer to the instructions included with the adapters for detailed installation information.

### **SWC Functions**

The following controls are available for most vehicles:

1. Volume Up
2. Volume Down
3. Mute
4. Seek Up
5. Seek Down
6. Source
7. Preset Up
8. Preset Down
9. Band

\*\*If additional SWC buttons are available on the vehicle, these features may be supported. All SWC functions may not be available on some vehicles.



## SETTINGS MENU

To access system settings, touch the Settings icon on the source menu or press the **SETUP** button on the remote control to enter the SETTINGS MENU. The General Sub-menu appears on the bottom of the screen highlighted in blue.



### Accessing Menu Items

Touch the sub-menu name on the bottom of the screen to select a sub-menu (General, Language, Rating, Audio, Hardware or Demo). The features available for adjustment under the highlighted sub-menu option will appear on the left of the screen.

### Adjusting a Feature

1. Touch an item on the touchscreen to select the feature to be adjusted. Touch the ▲ or ▼ icon to view the previous or next feature page, if applicable. An options list appears on the right.
2. Touch the option field for the feature you want to adjust. The feature option is updated.



## General Sub-menu Features

Setting	Options	Function
Tuner Region	USA	<ul style="list-style-type: none"> <li>• AM Frequency Spacing - 10 kHz</li> <li>• AM Frequency Band - 530 kHz ~ 1720 kHz</li> <li>• FM Frequency Spacing - 200 kHz</li> <li>• FM Frequency Band - 87.5 MHz ~ 107.9 MHz</li> </ul>
	S.Amer1	<ul style="list-style-type: none"> <li>• AM Frequency Spacing - 10 kHz</li> <li>• AM Frequency Band - 530 kHz ~ 1720 kHz</li> <li>• FM Frequency Spacing - 100 kHz</li> <li>• FM Frequency Band - 87.5 MHz ~ 108.0 MHz</li> </ul>
	Arabia	<ul style="list-style-type: none"> <li>• AM Frequency Spacing - 9 kHz</li> <li>• AM Frequency Band - 531 kHz ~ 1620 kHz</li> <li>• FM Frequency Spacing - 100 kHz</li> <li>• FM Frequency Band - 87.5 MHz ~ 108.0 MHz</li> </ul>
	China	<ul style="list-style-type: none"> <li>• AM Frequency Spacing - 9 kHz</li> <li>• AM Frequency Band - 522 kHz ~ 1620 kHz</li> <li>• FM Frequency Spacing - 100 kHz</li> <li>• FM Frequency Band - 87.5 MHz ~ 108.0 MHz</li> </ul>
	S. Amer2	<ul style="list-style-type: none"> <li>• AM Frequency Spacing - 5 kHz</li> <li>• AM Frequency Band - 520 kHz ~ 1600 kHz</li> <li>• FM Frequency Spacing - 100 kHz</li> <li>• FM Frequency Band - 87.5 MHz ~ 108.0 MHz</li> </ul>
	Europe	<ul style="list-style-type: none"> <li>• AM Frequency Spacing - 9 kHz</li> <li>• AM Frequency Band - 522 kHz ~ 1620 kHz</li> <li>• FM Frequency Spacing - 50 kHz</li> <li>• FM Frequency Band - 87.5 MHz ~ 108.0 MHz</li> </ul>
	Korea	<ul style="list-style-type: none"> <li>• AM Frequency Spacing - 9 kHz</li> <li>• AM Frequency Band - 531 kHz ~ 1602 kHz</li> <li>• FM Frequency Spacing - 200 kHz</li> <li>• FM Frequency Band - 88.1 MHz ~ 107.9 MHz</li> </ul>
RDS	Off	Turn On/Off the RDS feature.
	On	
CT	Off	System time is synchronized with current broadcast station time (Clock Time). Setting this feature to On will automatically set your system clock.
	On	
Clock Mode	12Hr	Clock displays 12 hour time using AM and PM.
	24Hr	Clock displays 24 hour time up to 23:59.



## VM9215BT

Setting	Options	Function
Clock	(HH:MM)	Clock appears in the top right corner of the screen during certain operations. <i>NOTE: The AM/PM indication will change as you continue to adjust the hour past 12.</i>
Beep	Off	No beep sounds.
	On	When turned on, an audible beep tone confirms each function selection.
TsCal	Yes	Press to access the touch screen calibration function.
Wallpaper	Black	Allows the user to select a screen background. The Wallpaper will not appear on the Main Source Menu, Camera source or EQ settings page.
	Motorsport	
	Space	
	Havoc	
	Sheet Metal	

# VM9215BT



## ***Language Sub-menu Features***

If a DVD supports more than one Subtitle or Audio language, all the languages are available for selection during playback. If the selected language is not supported by the DVD, then the default language is used.

<b>Setting</b>	<b>Options</b>	<b>Function</b>
Language	English	Display appears in English.
Subtitle	English	DVD subtitles automatically appear in English when available.
	Auto	DVD subtitles appear according to the default subtitle language specified on the disc.
	Off	DVD subtitles do not appear.
Audio	English	Audio is heard in English when the option is available.
DVD Menu	English	DVD menu (if applicable) is displayed in English.



**Rating Sub-menu Features**

The DVD system has a built-in parental lock feature to prevent unauthorized persons from viewing restricted disc content. By default, the rating system is unlocked. Once set up, the parental lock is released only by entering the correct password. Once the password is entered, rating is available for setup.

Setting	Options	Function
Set Password	----	Enter a 4-digit password to activate the "Rating" feature
Parental Ctrl	1. Kid Safe	Select the appropriate rating level for the intended audience. You may override higher ratings by using your password.
	2. G	
	3. PG	
	4. PG-13	
	5. PG-R	
	6. R	
	7. NC-17	
	8. Adult	
Load Factory	Reset	Select "Reset" to restore the factory default settings for the Rating system only.

To reset the password, access the "RATING" menu and enter the current password. Once the correct password is entered, you can access the "Password" field and enter a new one.

**NOTE:** Record the password and keep it in a safe place for future reference. The rating for each disc is marked on the disc, disc packing, or documentation. If the rating is not available on the disc, the parental lock feature is unavailable. Some discs restrict only portions of the disc, allowing the appropriate content to play. For details, please refer to the disc description.



## Audio Sub-menu Features

Setting	Options	Function
DRC	Off	Employ the Dynamic Range Control (DRC) for better playback for low volumes.
	On	
Loudness	Off	Select low frequency boost only or high and low frequency boost.
	LO	
	HI/LO	
Subwoofer	Off	Turns the subwoofer output on or off.
	On	
Sub Filter	80 Hz	Selects a crossover frequency to set a cut-off frequency for the subwoofer's Low-Pass Filter (LPF).
	120 Hz	
	160 Hz	
BASS Q	1.0	Adjust the Q / Bandwidth of the bass response of the selected Bass Center Frequency (BCF).
	1.25	
	1.5	
	2.0	
MID Q	0.5	Adjust the Q / Bandwidth of the midrange response of the selected Midrange Center Frequency (MCF).
	0.75	
	1.0	
	1.25	
Source	Radio	Choose a source for which you would like to increase or decrease the relative volume (LEVEL).
	Disc	
	USB1	
	USB2	
	AUX IN	
	Nav	
	BT	
Level	0 to 6	The default level is 3 (0dB reference): 0 = (-6dB) 1 = (-4dB) 2 = (-2dB) 3 = (0dB) 4 = (+2dB) 5 = (+4dB) 6 = (+6dB).



**Hardware Sub-menu Features**

If the rear-view video camera is connected, the unit is on, and the TFT monitor is retracted inside the unit, the TFT monitor automatically moves into the viewing position and Camera mode is selected upon shifting into REVERSE gear. When shifting into DRIVE gear, the TFT monitor is retracting back inside unit.

Setting	Options	Function
Color Select	White	This feature allows the user to select eight pre-defined LED colors for the front panel button illumination.
	Red	
	Blue	
	Green	
	Yellow	
	Purple	
	AquaBlue	
	SkyBlue	
	Custom	
Color Scan	On	The unit will “scan” the color spectrum to allow the user to select a color.
	Off	
Color Custom	Red	This feature allows the user to tune the RGB colors of the LEDs to obtain an exact match for their vehicle.
	Green	
	Blue	
Camera In	Normal	Reverse the camera image as if looking through a rear-view mirror.
	Mirror	
TFT Auto Open	On	The TFT panel automatically opens when the unit is turned on.
	Off	You must press the <b>OPEN</b> button to open the TFT panel.
	Manual	When the ignition is turned OFF, the TFT panel DOES NOT retract if it was previously out.
Video Input (Input circuitry auto detects the video signal from the Aux In source).	NSTC	The color signals are output in the standard NTSC format.
	PAL	The color signals are output in the standard PAL format.
	Auto	The color signal output is switched automatically based on the current video input signal - NTSC or PAL.



## VM9215BT



If the monitor is in display mode, the monitor automatically switches to CAMERA mode upon reverse driving. When the reverse driving stops, the monitor return to its original input mode.

### ***Demo Sub-menu Features***

The Demo mode is on and set to Auto run by default. The Demo mode will display various user interface TFT display pages such as the Radio, Disc, Aux In, and Camera sources. The Demo mode will also display the Equalizer and Settings menu pages. Touching any portion of the touch screen will pause the Demo mode temporarily. If the touch screen is not pressed again (within 30 seconds) the Demo mode will resume.

To turn the Demo mode off, access the Settings Menu and turn Auto run to OFF.

### ***TS Cal (Screen Calibration)***

To access the "Screen Calibration" function from the SETTINGS MENU, select the "TS CAL" option.

After entering calibration mode, a crosshair + appears in a corner quadrant of the screen. To begin calibration, touch and hold the crosshair for one second until it moves to the next quadrant. Continue for each quadrant until the calibration is completed.

### **Exiting the System Settings Menu**

To exit setup mode and resume normal playback, touch the **Setting** icon on the screen.



## TUNER OPERATION

### Opening/Closing the TFT Monitor

#### **Open TFT Monitor**

Press the **OPEN** button on the front panel or press the  button on the remote control to activate the mechanism that moves the display panel into the viewing position.

#### **Close TFT Monitor**

Press the **OPEN** button on the front panel or press the  button on the remote control to load the display panel back into the compartment.

### Tuner TFT Display

The on-screen indicators and touch key areas for the tuner functions are shown below.





1. **Radio** icon: Touch to view the SOURCE MENU and select a new playback source.
2. Current radio band indicator.
3. Stereo broadcasting indicator.
4. **Loc/Dx** Indicator: Strong/Local signal broadcasting indicator.
5. Equalizer setting indicator: Displays the current equalizer preset setting.
6. **EQ**  icon: Touch for quick access to Equalizer level settings.
7. Clock: Displays the time as entered by the user in the settings menu.
8. Program Information: This indicator provides three types of information: PS, RT, and PTY. PTY displays the program category of the current station such as category (news, sports, talk etc.) RT/PS provide the current song title, current song title, performing artist and station call letters.
9. Radio frequency indicator
10. **▶▶** icon: Touch to seek forward.
11. **▶** icon: Touch to tune forward one step.
12. **◀** icon: Touch to tune backward one step.
13. **◀◀** icon: Touch to seek backward.
14. **More** icon: Touch to toggle between menu page 1 and menu page 2.
15. **AS** icon: Touch to automatically store stations.
16. **PTY** icon: Touch to activate the program type related search function.
17. **Scan** icon: Touch to scan all stations available, stopping for 5 seconds at each and continuing until a station is selected.
18. **Mem** icon: Touch to display screen used to enter current channel into preset memory.
19. **Band** icon: Touch to change between AM/FM bands.
20. **Direct Entry** icon: Touch to access the direct entry screen.
21. Presets: Provides a display of the preset frequencies. Touch to recall preset stations.
22. **Options** icon: Touch to access CT and LOC functions.



**VM9215BT**

## Options Submenu

Touch the **Options** icon to display the **CT** and **LOC** functions on the Tuner TFT display screen.



- CT:** (Clock Time, RDS feature) When enabled the radio system clock is synchronized with broadcasters time signal setting the clock automatically. In some regions where daylight savings time is not adhered to, the system clock will be off by one hour. In these cases, set CT to OFF and manually set the clock.
- LOC:** This allows the user to activate local station reception function. When the Local function is on, only radio stations with a strong local radio signal are played.

## Switching to Radio Tuner Source

- Touch the top left corner of the screen (the radio box) to view the SOURCE MENU. Touch "Radio".
- Press the **SRC** button on the front panel to switch to the AM/FM or RADIO source.

## Selecting FM/AM Band

Touch the **Band** icon on the screen to change between the following bands: FM1, FM2, FM3, AM1, and AM2.

*NOTE: The BAND button on the front panel of the unit only works when the TFT is closed.*

## Seek Tuning

To seek the next higher station, touch the ►► button.

To seek the next lower station, touch the ◀◀ button.

## Manual Tuning

To increase or decrease the tuning frequency one step, touch the ◀ or ► button.

## Direct Tuning

To enter a radio station directly:

1. Touch the **Direct Entry icon** to display the DIRECT ENTRY MENU.



2. Enter the desired radio station frequency using the on-screen number pad. If you wish to delete an entry number touch the ◀◀ icon. Press **OK** to tune to the selected station and touch the **OK** button. To exit the screen without changing the station, touch **X**.



## Using Preset Stations

Six numbered preset buttons store and recall stations for each band. All six stored stations (P1 - P6) for the current band appear on the screen.

### Storing a Station

1. Select a band (if needed), then select a station.
2. Touch the on-screen **Mem** icon to access the preset screen.



3. Touch the preset number in which you would like to store the current station (or touch **X** to cancel and close the menu). The station frequency is displayed at the top of the menu. The preset number will appear highlighted. The station frequency will be stored in the highlighted preset. The station will be displayed on the front panel of the tuner screen.

### Recalling a Station

1. Select a band (if needed).
2. Touch an on-screen preset button to select the corresponding stored station.





## Auto Store (AS)

To select six strong stations and store them in the current band:

1. Select a band (if needed).
2. Touch the **AS** icon on the on-screen controls to activate the Auto Store function.

The new stations replace stations already stored in that band. If you have already set the preset memories to your favorite stations, activating the Auto Store feature will erase those stations and enter the new strong stations. This feature is most useful when travelling in an area where you are not familiar with the local stations.

## Preview Scan (SCAN)

To scan the AM or FM band for a preview of available stations in your particular area, touch **Scan**. The scan function will play the first five seconds of each station. When a desired station is reached, touch **Scan** again. Play of the selected station will continue and the preview scan will stop.

## Local Radio Station Seeking (LOC)

When the Local function is on, only radio stations with a strong local radio signal are played. To activate the Local function in the AM/FM tuner mode:

1. Touch the **Options** icon on the touch screen. A pop-up window appears.
2. Touch **LOC ON/OFF** to turn the local function on or off.

When the Local function is active, the **LOC** indicator at the top of the screen is illuminated. When the Distant function is active, the **DX** indicator at the top of the screen is illuminated.



## DVD/VCD VIDEO OPERATION

*NOTE: When properly installed, DVD video cannot be displayed on the main TFT screen unless the parking brake is applied. If you attempt to play a DVD while the vehicle is moving, the TFT screen display a parking brake notice. Rear video screens, if applicable, will operate normally.*

### Opening/Closing the TFT Monitor

#### Open TFT Monitor

Press the **OPEN** button on the front panel or press the button on the remote control to activate the mechanism that moves the display panel into the viewing position.

#### Close TFT Monitor

Press the **OPEN** button on the front panel or press the button on the remote control to load the display panel back into the compartment.







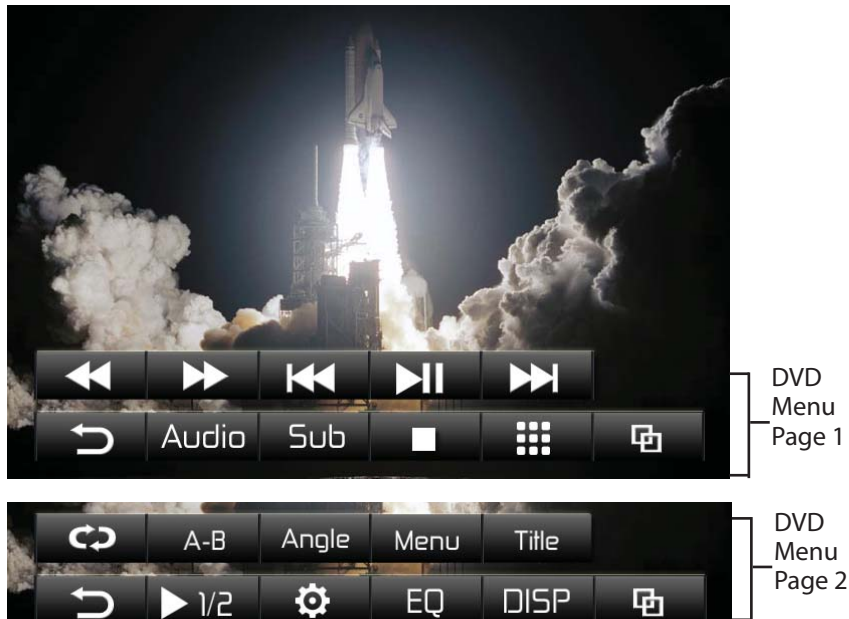







### DVD/VCD TFT Display

**Warning!!! It is illegal to view video while driving or operating a motor vehicle. Set parking brake to view video.**

To access the on-screen controls, touch the bottom 1/3 of the screen while a DVD is playing. Touch to view a second page of controls.





1.  icon: Touch to advance to the next chapter on the DVD.
2.  icon: Touch to see the second page of DVD controls.
3.  icon: Touch to select a chapter/track directly using the on-screen display direct entry menu display
4.  icon: Touch to stop DVD playback.
5. **Sub** icon: Touch during playback to select the subtitle language if the disc is recorded in multiple languages. Each time the icon is touched a different subtitle language is selected. The subtitle function can also be turned on or off.
6. **Audio** icon: Touch during playback to select to select the audio language. Each time the icon is touched a different audio language is selected if you are watching a disc recorded in multiple languages.
7.  icon: Touch to remove the DVD controls from the screen during DVD playback.
8.  icon: Touch to fast reverse. Keep touching and releasing the icon to increase the rate from "x2" to "x4", "x8", and "x20". Touch the icon again to resume normal play.
9.  icon: Touch to fast forward. Keep touching and releasing the icon to increase the rate from "x2" to "x4", "x8", and "x20". Touch the icon again to resume normal play.
10.  icon: Touch to move to previous chapter.
11.  icon: Touch to begin playback. Touch the icon again to pause playback.
12. **Title** icon: Touch to select a different title for playback. Select a title using the touch screen.
13. **DISP** icon: Touch to display playback information on the screen including the media playing and current playback time.
14. **EQ**: Touch for quick access to the Equalizer level settings.
15.  icon: Touch to view the SETTINGS menu.
16.  icon: Touch to select and activate Slow Motion Playback (Forward and Reverse). Touch to play the current title in slow motion. Keep touching and releasing the icon to change the rate from forward 1/2, 1/4, 1/6 and 1/8 speed. Continue for slow motion backward at 1/2, 1/4, 1/6 and 1/8 speeds. Touch the on-screen play icon () to resume normal play.
17.  icon: Touch during playback to repeat the current chapter. Touch the icon a second time to repeat the current title. Touch the icon a third time to turn the repeat function off.
18. **A-B** icon: Touch to repeat a specific portion from point A to point B of the DVD disc.
19.  icon: Touch to view angles if the DVD contains scenes shot from different angles.
20. **Menu** icon: Touch to display the DVD root menu.



**VM9215BT**

## **Controlling Playback**

### ***Inserting a Disc***

Upon inserting a DVD disc, DVD mode is entered and disc play begins.

***NOTE: If Parental Lock (Rating) is activated and the disc inserted is not authorized, the 4-digit code must be entered and/or the disc must be authorized (see "Rating Sub-menu Features").***

You cannot insert a disc if there is already a disc in the unit or if the power is off.

***NOTE: DVD-R and DVD-RW will not play unless the recording session is finalized and the DVD is closed.***

### ***Ejecting a Disc***

Press the **▲** button on the front of the unit to eject the disc. The unit automatically reverts to Tuner mode. You may eject a disc with the unit powered off. The unit will remain off after the disc is ejected.

### ***Resetting the Loading Mechanism***

If the disc loads abnormally or an abnormal core mechanism operation occurs, press and hold the **▲** button to reset the loading mechanism. Normal operation resumes.

### ***Accessing DVD Mode***

To switch to DVD mode when a disc is already inserted, press the **SRC** button on the front panel to access the source menu. Touch the disc icon.

### ***Repeat Playback***

Touch the button to alter repeat mode according to the following:

- DVD: Repeat Chapter, Repeat Title, Repeat Off
- VCD (PBC Off): Repeat Single, Repeat Off

***NOTE: For VCD play, the repeat function is not available if PBC is on.***

## Sectional Repeat Function (A-B)

Use the **A-B** function to define a specific area of a disc to repeat.

- Touch **A-B** on the second page of DVD on-screen controls to set the start point (A) of the repeated section.
- Touch **A-B** again once you reach the desired end point (B) of the repeated section. The selected portion of the DVD will now repeat continuously.
- Touch **A-B** a third time to cancel the A-B section setting and stop repeat play.

## Accessing the DVD Source Menu

- Touch **MENU** on the second page of DVD on-screens controls to recall the DVD source menu. Touch to select a title from the menu.
- Touch **TITLE** on the second page of DVD on-screen controls to select a different title for playback.
- Select a title using the touch screen.

## Moving Through Chapters

Touch **▶▶** to advance to the next chapter on the DVD.

Touch **◀◀** button to move to the previous chapter.

## Direct Chapter / Track Selection

To select a chapter/track directly:

1. Touch the on-screen **■** to display the Direct Entry Menu.



2. Enter the desired chapter/track using the on-screen number pad.
3. Touch the check mark to enter your selection. To exit the screen without changing the station, touch **X**. To clear your entry and start over, touch the back arrow.

## Viewing an Alternate Picture Angle (DVD Only)

Some DVDs contain scenes that have been shot simultaneously from different angles. For discs recorded with multiple angles, touch **△** on the second page of DVD on-screen controls to toggle available angles of the on-screen image.



## Multi-Language Discs (DVD Only)

### Changing Audio Language

If you are watching a disc recorded in multiple languages, touch **AUDIO** on the second page of DVD on-screen controls to choose a language. Each time the icon is touched the language will change.

### Changing Subtitle Language

If you are watching a disc recorded in multiple languages with subtitles, touch **Sub** on the second page of DVD on-screen controls to choose the language in which you would like the subtitles to appear.

*NOTE: During VCD playback, touch the AUDIO on the second page of DVD on-screen controls to choose between Left Channel, Right Channel, and Stereo.*

## PBC - Play Back Control (VCD Only)

For VCDs with play back functionality, play back control (PBC) provides additional controls for VCD playback.

Touch **PBC** on the first page of DVD on-screen controls to toggle the PBC function "On"/"Off". Once PBC is on, playback starts from track one of the play list.

*NOTE: When PBC is activated, fast forward, slow playback, and previous/next track are available. Repeat and direct track selection are not available.*

When PBC is activated, selecting random, scan, or search playback automatically deactivates PBC.

## Playback Information

During DVD and VCD playback, touch **DISP** on the second page of DVD on-screen controls to display playback information on the screen, including the media playing and current playback time.

### DVD Playback Information





- DVD Video – Format of current disc.
- Time 00:01:30/00:36:10 – Indicates the playback time of the current track.
- Title 5/08 – Indicates the fifth of 8 titles on the DVD is currently playing.
- Chapter 2/16 – Indicates that the second of 16 chapters on the DVD is currently playing.

### VCD Playback Information





- VCD2.0 – Format of current disc.
- Time 00:01:30/00:36:10 – Indicates the playback time of the current track.
- PBC On/Off – Indicates whether Play Back Control is On or Off.

## General Disc Information

**Table 6: Disc Properties**

Symbol	12 cm Disc Properties	Max Play Time
	Single side single layer (DVD-5)	(MPEG 2 Method) 133 minutes
	Single side double layer (DVD-9)	242 minutes
	Double side single layer (DVD-10)	266 minutes
	Double side double layer (DVD-18)	484 minutes
	Single side single layer (VCD)	(MPEG 1 Method) 74 minutes
	Single side single layer	74 minutes

**Table 7: Disc Symbols**

Symbol	Meaning
	Number of voice languages recorded. The number inside the icon indicates the number languages on the disc (maximum of 8).
	Number of subtitle languages available on the disc (maximum of 32).
	Number of angles provided (maximum of 9).
	Aspect ratios available. "LB" stands for Letter Box and "PS" stands for Pan/Scan. In the example on the left, the 16:9 video can be converted to Letter Box video.
	Indicates the region code where the disc can be played. <ul style="list-style-type: none"> <li>• Region 1: USA, Canada, East Pacific Ocean Islands</li> <li>• Region 2: Japan, Western Europe, Northern Europe, Egypt, South Africa, Middle East</li> <li>• Region 3: Taiwan, Hong Kong, South Korea, Thailand, Indonesia, South-East Asia</li> <li>• Region 4: Australia, New Zealand, Middle and South America, South Pacific Ocean Islands/Oceania</li> <li>• Region 5: Russia, Mongolia, India, Middle Asia, Eastern Europe, North Korea, North Africa, North-West Asia</li> <li>• Region 6: Mainland China</li> <li>• ALL: All regions</li> </ul>



## DVD/CD AUDIO OPERATION

### Opening/Closing the TFT Monitor

#### **Open TFT Monitor**

Press the **OPEN** button on the front panel or press the button on the remote control to activate the mechanism that moves the display panel into the viewing position.

#### **Close TFT Monitor**

Press the **OPEN** button on the front panel or press the button on the remote control to load the display panel back into the compartment.

### Media Requirements

The VM9215BT will play music or other audio files from the following disc media:









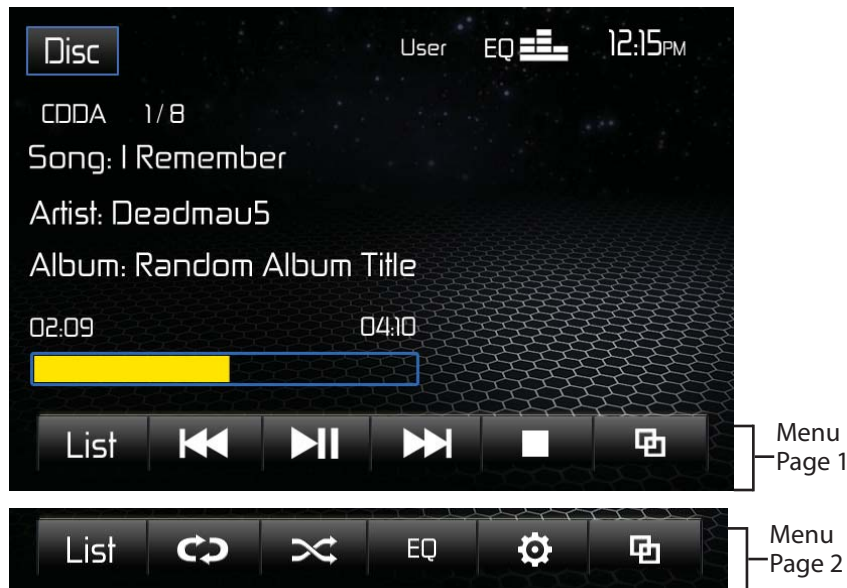

- CD-DA
- CD-R/RW
- DVD
- DVD+R/RW
- DVD-R/RW

Upon inserting a disc with the TFT screen open, the disc and track title (if available), along with the track number and playing time appear on the screen.

### CD TFT Display

The on-screen indicators and touch key areas for CD playback are outlined below.





1. **Disc** icon: Touch to view the SOURCE MENU and select a new playback source.
2. Repeat Play Indicator - This indicator is lit when the repeat mode is active.
3. Random Play Indicator - This indicator is lit when the random mode is active.
4. Equalizer setting indicator: Displays the current equalizer preset setting.
5. **EQ** : Touch for quick access to the Equalizer level settings menu.
6. Clock: Displays the time as entered by the user in the settings menu.
7.  Preview Window: Displays album art, if available.
8. Toggle (  ) icon: Touch to toggle between menu page 1 and menu page 2.
9. Stop (  ) icon: Touch to stop playback.
10. Next (  ) icon: Touch to play the next track.
11. Pause/Play (  ) icon: Touch to pause playback. Touch again to resume playback.
12. Previous (  ) icon: Touch to play the previous track.
13. **List** icon: Touch to display the Playlist screen.
14. Elapsed time Indicator: Displays the elapsed and total playing time of the current track playing.
15. Track Indicator: Displays the current track number playing and total number of tracks on disc.
16. Settings (  ) icon: Touch to view the SETTINGS menu.
17. **EQ** icon: Touch for quick access to the Equalizer level settings menu.
18. Repeat (  ) icon: Touch to alter repeat mode as follows: Repeat Single > Repeat Folder > Repeat All > Repeat Off
19. Random (  ) icon: Touch to alter random mode as follows: Random On > Random Off

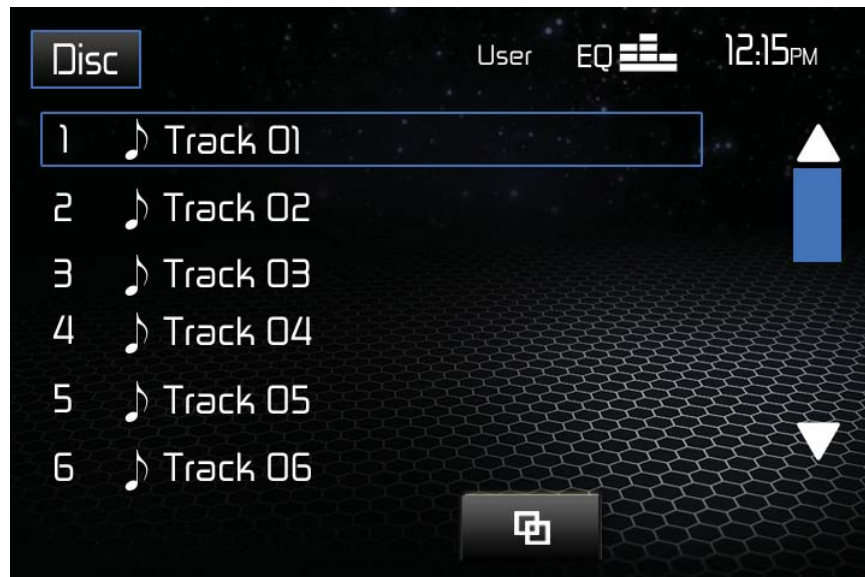

## Playlist Screen

The Playlist screen allows you to directly search for music on your disc.



- Touch a track title (if available) or track number to begin playback of that track.
- Touch ▲ to view the previous playlist page. Touch ▼ to view the next playlist page.
- Touch  to return to menu page 1.



## Controlling Playback

### ***Inserting a Disc***

Upon inserting a CD, disc play begins. You cannot insert a disc if there is already a disc in the unit or if the power is off.

### ***Ejecting a Disc***

Press the  button on the front of the unit to eject the disc. The unit automatically reverts to Tuner mode.

You may eject a disc with the unit powered off. The unit will remain off after the disc is ejected.

### ***Resetting the Loading Mechanism***

If the disc loads abnormally or an abnormal core mechanism operation occurs, press and hold the  button to reset the loading mechanism. Normal operation resumes.

### ***Stopping Playback***

Touch the Stop () icon to stop disc play.

To resume playback, touch the Pause/Play () icon.

### ***Pausing Playback***

Touch the Pause/Play () icon to suspend or resume disc play.

### ***Moving Through Tracks***

Touch the Next () icon to advance to the next track on the disc.

Touch the Previous () button to move to the previous track.

### ***Repeat Playback***

Touch the  icon to alter repeat mode according to the following:

- DVD: Repeat Single > Repeat Folder > Repeat All > Repeat Off
- CDDA: Repeat Single > Repeat Folder > Repeat All > Repeat Off
- CD-R/RW: Repeat Single > Repeat Folder > Repeat All > Repeat Off
- DVD-R/RW: Repeat Single > Repeat Folder > Repeat All > Repeat Off

### ***Random Play Select***

Touch the Random () icon to play the tracks on the disc in a random, shuffled order.

Touch the Random () icon again to cancel Random Play mode.

**NOTE: CD-R and CD-RW will not play unless the recording session is finalized.**



**VM9215BT**

## **MP3/WMA OPERATION**

### **Opening/Closing the TFT Monitor**

#### ***Open TFT Monitor***

Press the **OPEN** button on the front panel or press the  button on the remote control to activate the mechanism that moves the display panel into the viewing position.

#### ***Close TFT Monitor***

Press the **OPEN** button on the front panel or press the  button on the remote control to load the display panel back into the compartment.

### **Media and File Requirements**

This player allows you to play back MP3 and WMA files recorded onto CD-R/RWs, DVD+R/RWs, and DVD-R/RWs. For CD-RW discs, please make sure it is formatted using the full method and not the quick method to prevent illegal disc operation. For the greatest file capacity, Dual Layer DVD's can be used when burning music to a disc.

#### ***MP3 Format Compatibility***

The file naming formats listed below are compatible with this unit:

- ISO 9660 – file name: 12 characters, file extension: 3 characters
- ISO 9660 – file name: 31 characters, file extension: 3 characters
- Joliet – 64 characters

If the file or folder name does not conform to ISO 9660 file system standards, it may not be displayed or played back correctly. Use the following settings when compressing audio data for your MP3 disc:

- Transfer Bit Rate: 128 kbps
- Sampling Frequency: 48 kHz

When recording MP3 up to the maximum disc capacity, disable additional writing. For recording on an empty disc up to maximum disc capacity, use the "Disc at once" setting.

#### ***MP3 Playing Order***

When selected for play, files and folders (Folder Search, File Search or Folder Select) are accessed in the order they were written by the CD writer. As a result, the order in which they are expected to be played may not match the order in which they are actually played. You may be able to set the order in which MP3/WMA files are to be played by writing them onto a medium such as a CD-R with their file names beginning with play sequence numbers such as "01" to "99".

# VM9215BT



For example, a medium with the following folder/file hierarchy is subject to Folder Search, File Search or Folder Select, as shown below.

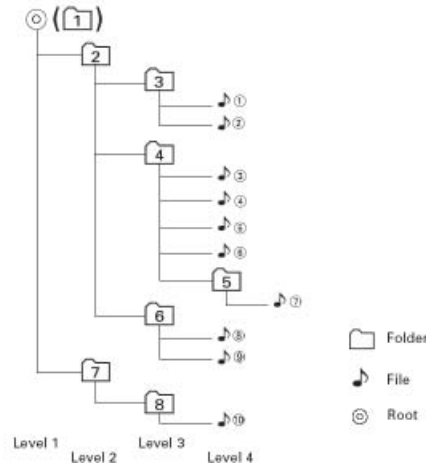

The VM9215BT player will only recognize three folder levels and does not display folders containing only other folders. In the example above, the unit will display folders 3, 4, 6, and 8, but not 2 and 7 since they do not contain any tracks directly. Folder 5 is not recognized at all since it is at the fourth level.

## Inserting a USB Device

**NOTE:** The USB port will recognize most USB flash memory devices and portable hard drives (hard drives must be formatted to FAT32 and NTFS is not supported).

**NOTE:** Front and rear USB ports are for Apple devices, USB memory sticks or portable HDD. The rear 3.5mm connector (bundled with the USB port) is for iPod® / iPhone® video only.

1. Locate the USB interface cover on the front of the radio.

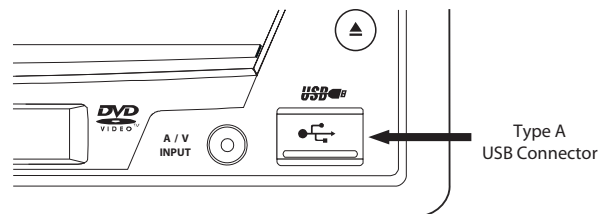

2. Lift the protective cover to expose the USB connector.
3. Insert the USB device into the USB connector. The unit will read the audio/video files on the USB device automatically.

## Removing a USB Device









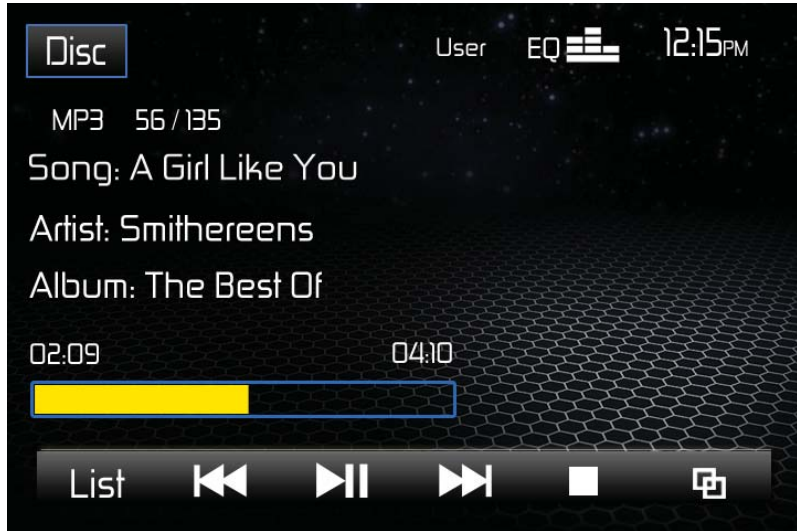

To remove the USB device, press the **SRC** button or use the SOURCE MENU to switch to another mode, and then remove the USB device from the connector.



### MP3/WMA TFT Display

The on-screen indicators and touch key areas for MP3/WMA playback are outlined below.



1. **DISC**: Touch to view the SOURCE MENU and select a new playback source.
2. Repeat Play Indicator - This indicator is lit when the repeat mode is active.
3. Random Play Indicator - This indicator is lit when the random mode is active.
4. Equalizer setting indicator: Displays the current equalizer preset setting.
5. **EQ** : Touch for quick access to the Equalizer level settings menu.
6. Clock: Displays the time as entered by the user in the settings menu.
7.  Preview Window: Displays album art, if available.
8. Toggle icon (  ): Touch to toggle between menu page 1 and menu page 2.
9. Stop (  ) icon: Touch to stop MP3/WMA playback.
10. Next (  ) icon: Touch to play the next track.
11. Pause/Play (  ) icon: Touch to pause playback. Touch again to resume playback.
12. Previous (  ) icon: Touch to play the previous track.
13. **List** icon: Touch to display the Playlist screen.
14. Playback Information Display: Displays song, artist, album and elapsed/total playing time of the current track playing.
15. Track Indicator: Displays the current track number playing and total number of tracks on disc/USB device.
16. Settings (  ) icon: Touch to view the SETTINGS menu.
17. **EQ** icon: Touch for quick access to the Equalizer level settings menu.
18. Repeat (  ) icon: Touch to alter repeat mode as follows: Repeat Single > Repeat Folder > Repeat All > Repeat Off
19. Random (  ) icon: Touch to alter random mode as follows: Random On > Random Off



VM9215BT

## Playlist Screen

The Playlist screen allows you to directly search for music, video or photo files stored on your MP3 disc/USB device.

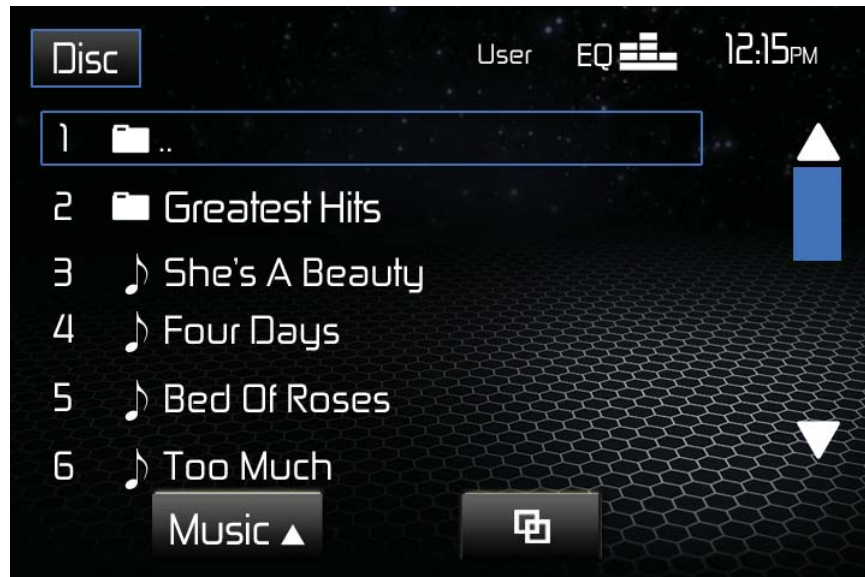

- Touch a folder to view the contents of the directory or touch a track title/file name to begin playback of that file.
- Touch ▲ to view the previous playlist page. Touch ▼ to view the next playlist page.
- Touch  to return to menu page 1.

## *Search Playlist by File Type*

1. Touch the MUSIC ▲ icon.

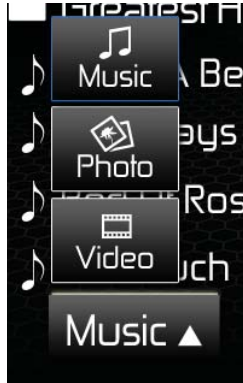

2. Touch "MUSIC," "PHOTO" or "VIDEO". The list of files that appear will be filtered by the type of file selected.



## Controlling Playback

### **Inserting a Disc**

Upon inserting a MP3/WMA disc, disc play begins. You cannot insert a disc if there is already a disc in the unit or if the power is off.

### **Ejecting a Disc**

Press the  button on the front of the unit to eject the disc. The unit automatically reverts to Tuner mode.

You may eject a disc with the unit powered off. The unit will remain off after the disc is ejected.

### **Resetting the Loading Mechanism**

If the disc loads abnormally or an abnormal core mechanism operation occurs, press and hold the  button to reset the loading mechanism. Normal operation resumes.

### **Playing MP3/WMA Files**

After inserting a MP3/WMA disc, files will play in the sequence of the "Root" directory.

***NOTE: When burning MP3 / WMA files onto a DVD disc, use the 2X or 4X burning option, if available. This slower burning speed will help eliminate buffer errors and increase disc reading reliability. Also, use folders when burning large numbers of songs / files to a disc for easy music navigation. Select the "Disc at Once" option and close your disc.***

### **Stopping Playback**

Touch the Stop () icon to stop playback.

To resume playback, touch the Pause/Play () icon.

### **Pausing Playback**

Touch the Pause/Play () icon to suspend or resume playback.

### **Moving Through Tracks**

Touch the Next () icon to advance to the next track



Touch the Previous () button to move to the previous track on the MP3 disc/USB device.

### **Repeat Playback**

Touch the Repeat () icon to alter repeat mode as follows: Repeat Single > Repeat Folder > Repeat All > Repeat Off

***NOTE: CD-R and CD-RW will not play unless the recording session is finalized.***

### **Random Play Select**

Touch the Random () icon to play the tracks on the MP3 disc/USB device in a random, shuffled order. Touch the Random () icon again to cancel Random Play mode.





## iPod®/ iPhone® OPERATION

This unit is Made for iPod® and iPhone®. You can control your iPod® and iPhone® via the touch screen to access Playlist, Artist, Albums, Songs, etc. Supported models include, but are not limited to the following:

- iPhone® 4S / 4 / 3GS / 3G and 1st Generation
- iPod® touch 4th / 2nd and 1st Generation
- iPod® nano 6th / 5th / 4th and 3rd Generation
- iPod® classic and iPod® with video

**NOTE:** Be sure your iPod® has the latest Apple firmware installed to avoid connectivity issues.

### Opening/Closing the TFT Monitor

#### **Open TFT Monitor**

Press the **OPEN** button on the front panel or press the  button on the remote control to activate the mechanism that moves the display panel into the viewing position.

#### **Close TFT Monitor**

Press the **OPEN** button on the front panel or press the  button on the remote control to load the display panel back into the compartment.

### Accessing iPod® Mode

The unit will automatically switch to iPod® mode when an iPod®, iPod® touch or iPhone® is plugged into the front or rear USB connector.

**NOTE:** For basic iPod® connectivity, you can use the white 30-pin to USB iPod cable that came with your Apple device. For iPod® video or photo playback, you must purchase the jLink-USB cable.

To return to the iPod® menu from any other source menu, touch **SRC** on the front panel until the iPod® menu appears on the screen, or choose the iPod® icon from the source menu (only available when an iPod® or iPhone® is connected to the USB connector).





VM9215BT

## Search Screen

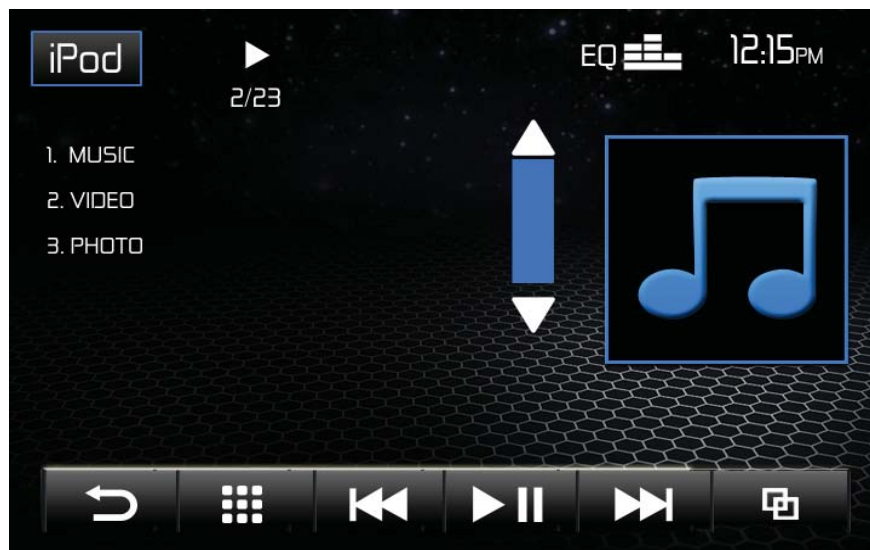
The Search Screen allows you to search for music or video files stored in your iPod®/ iPhone®. Touch the Music list box to search for music grouped by playlists, artists, albums, songs, genres, composer or podcast. Touch the Video list box to search for videos grouped by movie, music videos, TV shows, video podcasts, rentals, and video playlists. Photos are displayed by using the iPod®/iPhone® to control and select photos.



1. **iPod** icon: Touch to view the SOURCE MENU and select a new playback source.
2. **▶ / ▶||** indicator: Indicates whether media is playing or paused.
3. **2/23** indicator: File number and total number of files on the disc.
4. **EQ**  icon: Touch for quick access to Equalizer level settings menu.
5. **Clock**: Displays the time as entered by the user in the settings menu.
6. **🎵** Preview Window: Displays album art, if available.
7. **Toggle** () icon: Touch to toggle between menu page 1 and menu page 2.
8. **Next** (**▶▶**) icon: Touch to play the next track.
9. **Pause/Play** (**▶||**) icon: Touch to pause playback. Touch again to resume playback.
10. **Previous** (**◀◀**) icon: Touch to play the previous track.
11. **Grid** () icon: Touch to select a chapter/track directly using the on-screen display direct entry menu display.
12. **Back** (**↶**) icon: Touch to return to a previous menu.

## Controls and Indicators

The on-screen indicators and touch key areas for iPod® playback are outlined below.

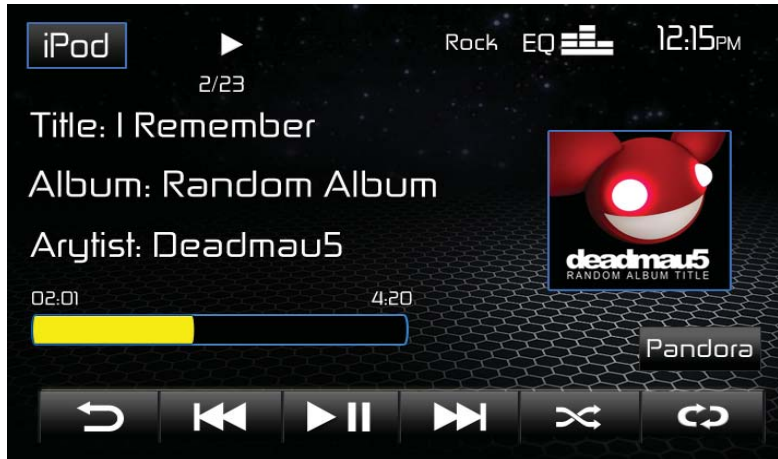

1. **iPod** icon: Touch to view the SOURCE MENU and select a new playback source.
2. **▶ / ▶||** indicator: Indicates whether media is playing or paused.
3. Equalizer setting indicator: Displays the current equalizer preset setting.
4. **EQ** icon: Touch for quick access to Equalizer level settings menu.
5. Clock: Displays the time as entered by the user in the settings menu.
6. Repeat ( ) icon: Indicates the repeat function is enabled.
7. Random ( ) icon: Indicates the random function is enabled.
8. **2/23**: File number and total number of files on the disc.
9. Song title, album, and performing artist.
10. **02:01**: Elapsed playing time and playback progress bar for current file.
11. **04:20** Total playing time for current file.
12. Preview Window: Displays album art, if available.
13. **Pandora** icon: Touch to play Pandora radio. The Pandora app on your iPhone® /iPod® touch must be launched.
14. Repeat ( ) icon: Touch to alter repeat mode as follows: Repeat Single > Repeat Folder > Repeat All > Repeat Off
15. Random ( ) icon: Touch to alter random mode as follows: Random On > Random Off
16. Next ( ) icon: Touch to play the next track.
17. Pause/Play ( ) icon: Touch to pause playback. Touch again to resume playback.
18. Previous ( ) icon: Touch to play the previous track.



### Controlling Your iPod®

Touch the MENU button to access the main iPod® menu. Use the touchscreen to navigate the iPod® menus.

#### Direct Track Entry

To select a track directly:

1. Touch the  icon to display the Direct Entry Menu.

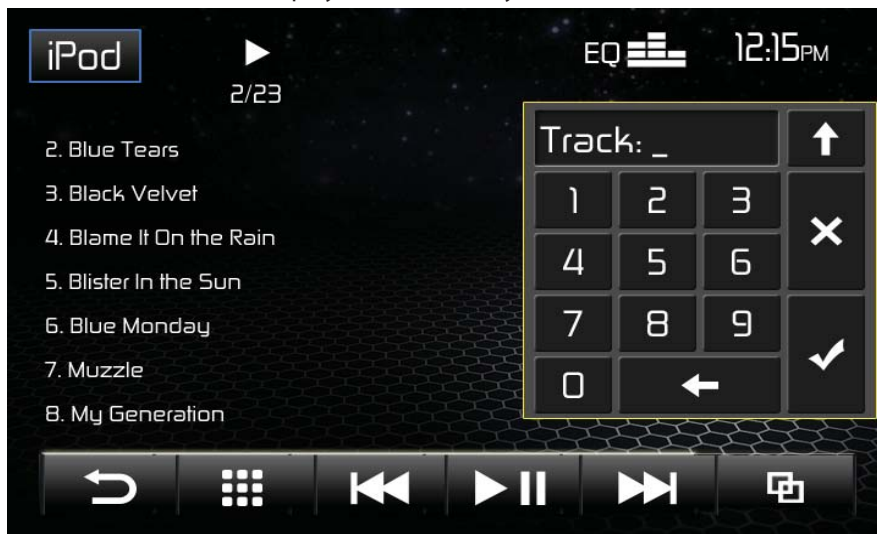

2. Touch to select a chapter/track directly using the direct entry menu by entering the desired track number.
3. Touch **OK** to play the selected file. To exit the screen without changing the file, touch the large **X**. To clear your entry and start over, touch the small **x**.

**NOTE:** To transmit the video from your iPod® to the VM9215BT screen, you must set the following options through the iPod® video settings menu:  
TV Out = On, TV Signal = NTSC, and Widescreen = On.

**NOTE:** After disconnecting your iPod®, the VM9215BT will always return to the last mode accessed when the iPod® is plugged back into the unit.

## PANDORA RADIO OPERATION

Pandora Radio is available via your iPhone® (data usage will occur) or iPod® touch (Wi-Fi).

*NOTE: For basic iPod®/iPhone® connectivity, you can use the white 30-pin to USB iPod cable that came with your Apple device. For iPod® video or photo playback, you must purchase the jLink-USB cable.*

*NOTE: The Pandora app must be installed on your iPhone®/iPod® touch.*



### Pandora Radio TFT Display

The on-screen indicators and touch key areas for Pandora Radio functions are outlined below.



1. **Pandora** icon: Touch to view the SOURCE MENU and select a new playback source.
2. **▶** or **||** indicator: Indicates whether Pandora Radio is playing (**▶**) or paused (**||**).
3. Equalizer setting indicator: Displays the current equalizer preset setting.
4. **EQ**  icon: Touch for quick access to Equalizer level settings menu.
5. Clock: Displays the time as entered by the user in the settings menu.
6. Playback Information Display: Displays station, track, artist, album, and elapsed time information.
7. Pandora Preview Window: Displays album art, if available.
8. **iPod** icon: Touch to return to the iPod® mode of operation.
9. **▶▶** Next icon: Press this icon skip a song, subject to the skip limit.
10. **▶** Play or **||** Pause icon: Press the **▶** icon to begin playback. Press the **||** icon to pause playback.



11.  **Thumbs Up icon:** Press this icon to tell Pandora “you like this track” and bring in more tracks like it to your station.
12. **Book Mark icon:** Touch to display the Add Bookmark submenu to bookmark a new song or artist.
13.  **Thumbs Down icon:** Press this icon to tell Pandora to not play this track. Pandora will skip to the next track. If the skip limit has been reached, Pandora will continue to play but your feedback will be recorded.
14. **List icon:** Touch this icon to access the Station List Screen.

### ***Bookmark Submenu***

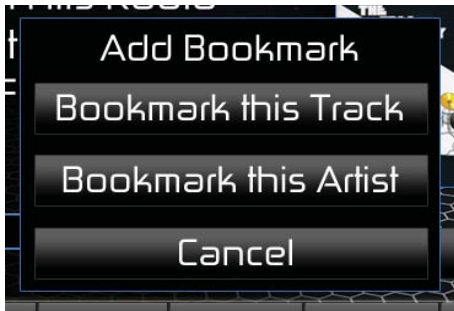

- Touch the **Bookmark this Track** icon to bookmark a track.
- Touch the **Bookmark this Artist** icon to bookmark an artist.
- Touch the **Cancel** icon to return to the Pandora Radio screen.

## Station List Screen

The Station List Screen allows you to search for music by the stations you created.



- Touch a station on the list to choose that station.
- Touch the Scroll Down (▼) icon to view the next page in the list or the Scroll Up (▲) icon to view the previous page.

## To Start/Stop Pandora Radio

1. Launch the Pandora app on your iPhone®/iPod® touch. The Pandora icon appears on the Main Menu Screen.



2. Touch the Pandora icon. The Pandora Screen appears.



3. Touch the ► icon to begin playback or the || icon to pause playback..
4. Touch the iPod icon to exit Pandora and return to the iPod Screen.



5. Touch the Pandora icon to return to Pandora Radio.



**Pandora Radio Error Messages**

The Pandora Radio error messages are listed in Table 8.

**Table 8: Pandora Radio Error Messages**

<b>Error</b>	<b>Solution</b>
BookMark Track Error	The track could not be bookmarked, please try again in a moment.
BookMark Artist Error	The artist could not be bookmarked, please try again in a moment.
Thumbs Up / Down Error "Error Track Rating"	Song feedback could not be sent, please try again in a moment.
No Active Station Error	This account has no stations in it. Please visit Pandora.com and login to your account and add stations.
Skip Limit Reached	Please note that Pandora limits skips to a maximum of six skips per station, per hour.



**VM9215BT**

## **BLUETOOTH OPERATION**

Bluetooth® was launched by a special interest group (SIG) comprised of Ericsson Inc., Intel Corp., Nokia Corp., Toshiba and IBM in 1998, and it is currently developed by nearly 2,000 companies worldwide. The Bluetooth® word mark and logos are owned by the Bluetooth SIG, Inc. and any use of such marks by Audiovox Corporation is under license. Other trademarks and trade names are those of their respective owners.

Bluetooth® technology has the capability to wirelessly synchronize and transfer data among devices. The Bluetooth® audio capabilities can be used for mobile phones hands free applications. Bluetooth® has many profiles and the unit is compatible with most Bluetooth® enabled mobile phones. Before attempting to use the Bluetooth® functions on the unit, please make sure your mobile phone supports Bluetooth® functions.

***NOTE: The line-of-sight distance between this unit and your mobile phone must be 8 feet (2.4 meters) or less for sending and receiving voice and data via Bluetooth® wireless technology.***





Please make sure your mobile phone supports Bluetooth® functions (Headset or Handsfree profiles or both). Adhere to the following guidelines for successful operation:

- Before using Bluetooth® functions, you must pair your mobile phone to the VM9215BT head unit (see "Pairing the Bluetooth® System with Your Mobile Phone and Head Unit"). To ensure the best reception for pairing and reconnection, please make sure the phone battery is fully charged before you begin.
- Try to perform pairing within a few minutes of the phone being turned on.
- Once the unit has been paired with the phone, the unit's model number, "VM9215BT", will be displayed on the mobile phone.
- To achieve the best performance, always keep the mobile phone within 3 meters of the head unit.
- Always keep a clear path between the mobile phone and the head unit. Never place a metal object or any other obstacle between the mobile phone and the head unit.
- Some mobile phones (like Sony Ericsson) may have a "Power Saving Mode" option. PLEASE DO NOT use the power saving mode with the VM9215BT.
- Before accepting or making a call, make sure your mobile phone's "Bluetooth function" is turned on.
- To ensure the best conversation quality/performance, stay within one meter of the microphone when talking.
- To "disconnect" the mobile phone from the head unit, turn the Bluetooth® connectivity off on the mobile phone or touch the button.

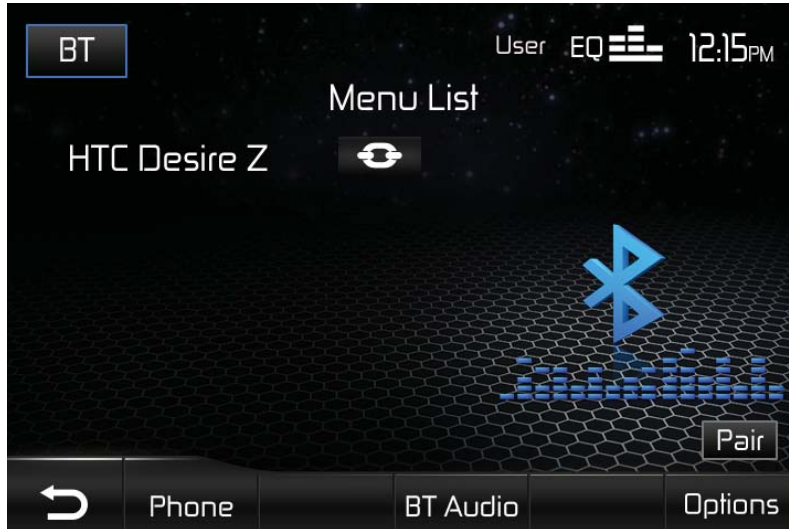
## Bluetooth User Interface

The on-screen indicators and touch key areas for Bluetooth® functions are outlined below.



1. **BT** icon: Touch to view the SOURCE MENU and select a new playback source.
2. Equalizer setting indicator: Displays the current equalizer preset setting.
3. EQ  icon: Touch for quick access to Equalizer level settings.
4. Clock: Displays the time as entered by the user in the settings menu.
5.  /  indicator: Indicates whether the unit is disconnected/connected with a Bluetooth® device.
6. **Pair** icon: Touch to initiate the pairing process with a Bluetooth® device.
7. **Options** icon: Touch to configure Bluetooth® parameters and options. Refer to the Options screen for further details.
8. **BT Audio** icon: Touch to access the Bluetooth® music function.
9. **Phone** icon: Touch to access the phone call menu.
10.  icon: Touch to return to a previous menu.



## VM9215BT

### Hands Free Profile (HFP)

To use a mobile phone with this unit, it is necessary to first establish a connection using Bluetooth® wireless technology. The connection is normally established using Hands Free Profile (HFP), which gives you full control of functions available on the telephone source. However, depending on your phone, the connection may be made using Head Set Profile (HSP), making some functions unavailable. This is a limitation of your phone, not the VM9215BT.

Since there are a number of Bluetooth® mobile phone implementations available on the market, operations with your Bluetooth® mobile phone using this unit vary greatly. Please refer to the instruction manual that came with your Bluetooth® mobile phone along with this manual while operating your phone with this unit.

### Pairing Your Mobile Phone with the Head Unit

Your mobile phone can initiate a search for new devices and pair to the unit. The following procedure describes the pairing process.

**NOTE: The following procedures are generic. Procedures for pairing mobile phones may vary slightly from phone manufacturer to phone manufacturer.**

1. Press the **SRC** button on the front panel to access the source menu.
2. Touch the BT icon on the source menu and the Bluetooth® user interface screen will appear.
3. Touch the **Options** icon and the following screen will appear.

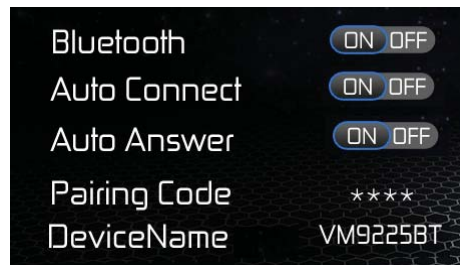

4. On the **Options** submenu set the **Bluetooth** function to ON.
5. On the **Options** submenu set the **Connect** function to ON.
6. Press the "Pair" button on the head unit's Bluetooth® user interface screen.
7. Access the mobile phone Bluetooth® function and set the function to ON.
8. Set the mobile phone Bluetooth® discover mode to ON.

**NOTE: Some discovery modes have a time limit (usually a minute) before they are automatically turned off.**

9. Use the mobile phone's add a new device feature. A device or devices will appear on your mobile phone display.

## VM9215BT



10. A prompt to pair or bond should appear on your mobile phone. Accept the request and initiate the process.

**NOTE:** Some mobile phones require a “pass key” or pairing code to connect. If your phone requires a pass key or pairing code, you will need to enter this number. The default pairing code for many wireless phones is “0000”. The default code for the unit is “1234”.

11. A prompt to enter a PIN number or passkey for the unit should appear. The default passkey for the unit is “1234”.

12. At this point a prompt stating that pairing is successful should appear. Another prompt should appear asking connect to the unit, Yes or No. Press Yes. The mobile phone and the unit should connect. The mobile phone should display a message similar to “Device Connected.” The mobile phone and the unit are now connected. VM9215BT will appear on the mobile phone list of devices.

### Managing Incoming Calls



When connected to a Bluetooth® phone, the unit will mute audio output, pause CD play, and change to the Bluetooth screen below when a call is received. The incoming phone number or as-assigned name for that number will appear in the top of the screen. An audible tone will sound from the unit and a graphic display will appear on the front panel. If the incoming call has no caller ID, the unit will display “Private Caller”.





1. **Direct Entry** icon: Touch to access the direct dial screen. Refer to the Direct Entry screen for further detail.
2. icon: Touch to answer an incoming call.



**VM9215BT**

3. **Transfer Call** icon: Touch to transfer a call back to the mobile phone.
4. **Mute** icon: Touch to mute the microphone audio from the unit. Touch the icon again to restore the microphone and audio from the unit.
5.  icon: Touch to end an incoming call.
6.  icon: Touch to return to a previous menu

### **Answering an Incoming Call**

Touch the  icon. For best reception, speak loudly and clearly into the microphone. To end the conversation, touch the  icon.

### **Rejecting an Incoming Call**

Press the **Transfer Call** icon to reject an incoming call. The call will revert to your mobile phone and be left for voice mail.

### **Volume Control**

To increase or decrease the volume level of an incoming call, turn the rotary knob on the front panel or press the **VOL+ / VOL-** buttons on the remote control.

### **Audio Mute**

To mute the phone call audio from the unit when a call is received, press the front panel rotary knob. Press the front panel rotary knob again and phone call audio will be restored to the unit.



## Making an Outgoing Call

Outgoing calls can be performed by touching the **Direct Entry** icon and using the unit's touch screen keypad.

### *Direct Dialing*

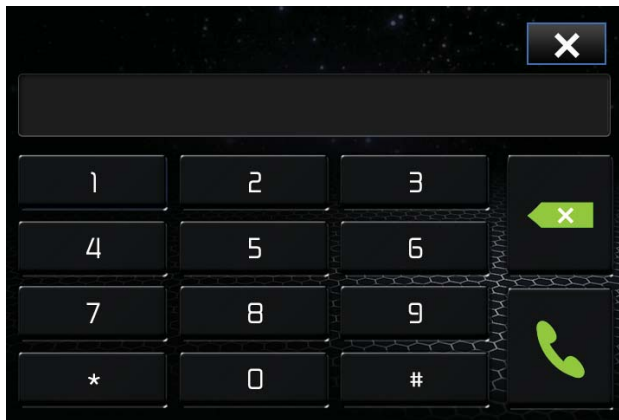
1. Touch the **Direct Entry** icon and the following screen will appear:



2. Using the keypad, touch **0-9,\*** or **#** to enter the phone number you wish to dial. If you enter an incorrect number touch the  icon to delete the incorrect number.
3. Once the correct number appears on the screen touch the  icon. To exit the direct entry screen touch the **X**.
4. To end the call touch the  icon on the previous screen.



VM9215BT

## Call Transfer

While talking, to transfer audio from the unit back to the wireless phone, touch the **Transfer Call** icon. You can only transfer a call after it has been answered. Touching the **Transfer Call** icon again will return the audio from the mobile phone to the unit. Touch the **Transfer Call** icon and the following screen will appear:





## Bluetooth Music Function (BT Audio/A2DP)

Bluetooth provides an Advanced Audio Distribution Profile (A2DP) profile for streaming music from a wireless phone or a portable multimedia player (PMP), sometimes referred to as a MP3 player. The unit allows you to play back audio files from your wireless phone or a PMP using a Bluetooth connection.

**NOTE: Please quit A2DP mode before attempting to make a phone call, as unexpected results may occur depending on your wireless phone model.**

The unit can control a Bluetooth audio player via Advanced Audio Distribution Profile (A2DP) or Audio/Video Remote Control Profile (AVRCP). Bluetooth audio players (or Bluetooth adapters) compatible with these profiles can be connected to this unit. Touch the **BT Audio** icon and the following screen will appear:

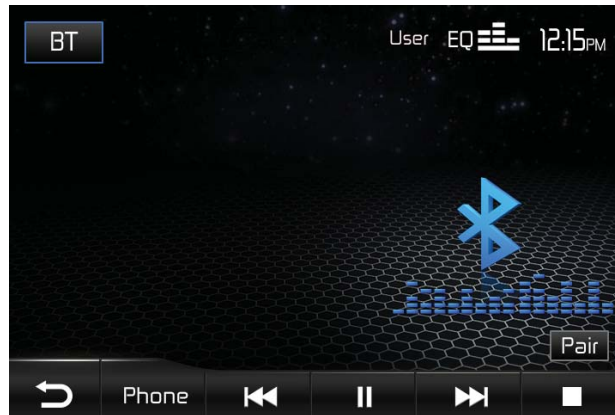

While listening to audio the following functions are available:

1. Pause/Play (▶/||) icon: Touch to pause playback. Touch again to resume playback.
2. Previous (◀◀) icon: Touch to play the previous track.
3. Next (▶▶) icon: Touch to play the next track.
4. Touch the Stop (■) icon to stop playback .



## VM9215BT

---

Functionality varies depending on the profile used:

- A2DP: Stream audio from your Bluetooth compatible audio player and listen to the music through the unit.
- AVRCP: Play back, pause, select songs, etc. while streaming audio from your Bluetooth compatible audio player to the unit.

***NOTE: Song information (e.g. elapsed playing time, song title, song index, etc.) cannot be displayed on this unit. Since there are a number of Bluetooth audio players available on the market, operations with your Bluetooth audio player using this unit vary greatly. Please refer to the instruction manual that came with your Bluetooth audio player.***

When there is an incoming call, the song will be paused. After the incoming call is finished, the screen will return to the music function screen and playback will continue.



## SiriusXM® RADIO OPERATION

Everything worth listening to is on SiriusXM®, getting over 130 channels, including the most commercial-free music, plus the best sports, news, talk and entertainment. A Vehicle Tuner (sold separately) and subscription are required. For more information, visit [www.siriusxm.com](http://www.siriusxm.com).

Sirius, XM and all related marks and logos are trademarks of Sirius XM Radio Inc. and its subsidiaries. All other marks and logos are the property of their respective owners. All rights reserved.

### Activating SiriusXM® Radio

Satellite Radio operation requires the connection of an optional Vehicle Tuner and antenna (sold separately). To connect the Vehicle Tuner, follow the instructions provided with the tuner.

To listen to Satellite Radio, a subscription is required.

Activate the Vehicle Tuner using one of the two methods below:

- Online: Go to [www.siriusxm.com](http://www.siriusxm.com) and choose ACTIVATE RADIO.
- Phone: Call 1-800-XM-RADIO (1-800-967-2346).

Activation typically takes 10-15 minutes, but may take up to an hour. It is recommended to leave your vehicle on until the "Subscription Updated" message appears.

### Retrieving the Radio ID Code

The Satellite Radio Subscription requires that the Radio ID be retrieved. To display the Radio ID:

1. Touch the **Direct** icon. The Direct Entry Menu appears.
2. Tune to channel "0" using the on-screen number pad.
3. Touch the check mark to enter your selection. The screen displays the ID where the channel name is displayed.

## Opening/Closing the TFT Monitor

### Open TFT Monitor

Press the **OPEN** button on the front panel or press the  button on the remote control to activate the mechanism that moves the display panel into the viewing position.

### Close TFT Monitor

Press the **OPEN** button on the front panel or press the  button on the remote control to load the display panel back into the compartment.



### SiriusXM® User Interface

The on-screen indicators and touch key areas for SiriusXM® functions are outlined below.

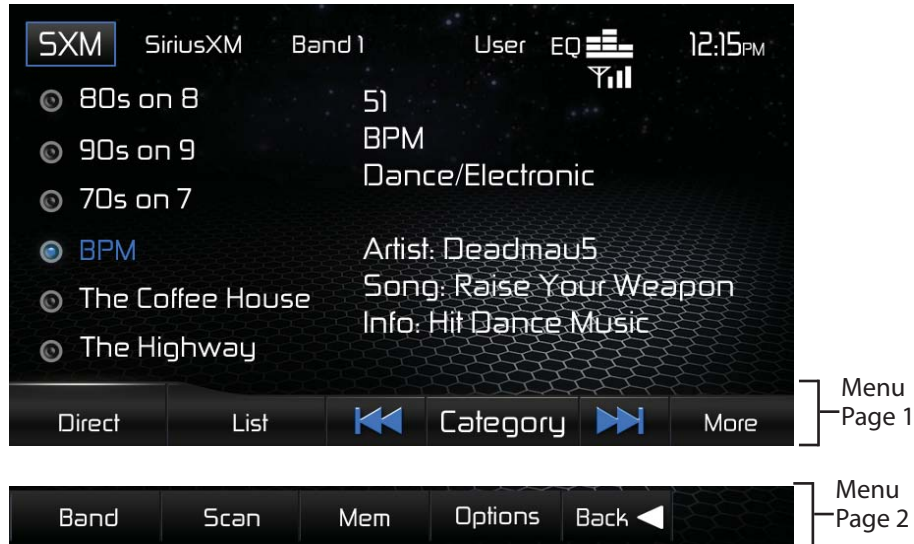

1. **SXM** icon: Touch to view the SOURCE MENU and select a new playback source.
2. Band indicator - Displays SiriusXM® radio band currently selected.
3. Equalizer setting indicator: Displays the current equalizer preset setting.
4. **EQ** : Touch for quick access to the Equalizer level settings menu.
5. Signal Strength indicator : As the strength of the satellite radio signal increases, the number of illuminated segments will increase.
6. Clock: Displays the time as entered by the user in the settings menu.
7. **More** icon: Touch to go to Menu Page 2.
8. Next () icon: Touch to tune to the next channel.
9. **Category/Channel** icon: Touch to toggle the icon displayed between Category and Channel.
10. Previous () icon: Touch to tune to the previous channel.
11. **List** icon: When the Category icon is displayed, touch List to go to the Category Screen. When the Channel icon is displayed, touch List to go to the Channel Screen.
12. **Direct** icon: Touch to display the Direct Entry Menu.
13. **Back** icon: Touch to go to Menu Page 1.
14. **Options** icon: Touch to go to the SXM Parental Lock Menu.

## VM9215BT

---



15. **Mem** icon: Touch to display screen used to enter current channel into preset memory.
16. **Scan** icon: Touch to scan to the next available channel. The tuner will pause for approximately five seconds at that channel. Touch scan again to listen to that channel. If scan is not touched, the tuner will automatically seek the next channel.
17. **Band** icon: Only six preset channels will display at a time. Touch this icon to display the next band of preset channels. Three bands are available: Band 1, Band 2, and Band 3.



### Switching to SiriusXM® Radio

- Touch the top left corner of the screen (the radio box) to view the SOURCE MENU. Touch the “SiriusXM” icon.
- Press the **SRC** button on the front panel to switch to the SXM source.

### Selecting the SiriusXM® Band

Touch the **Band** icon on the screen to change between the following bands: Band1, Band2, and Band3.

### Seek Tuning

- To seek the next higher channel, touch the ►► icon.
- To seek the next lower channel, touch the ◀◀ icon.

### Direct Tuning

To enter a SiriusXM® radio channel directly:

1. Touch the **Direct** icon to display the DIRECT ENTRY MENU.



2. Enter the desired SiriusXM® radio channel using the on-screen number pad. If you wish to delete an entry number touch the ◀-X icon.
3. Touch the check mark icon to tune to the selected channel. To exit the screen without changing the channel, touch the X icon.

## Using Preset Stations

Six numbered preset buttons store and recall channels for each band. All six stored channels for the current band appear on the screen.

### Storing a Channel

1. Select a band (if needed), then select a channel.
2. Touch the on-screen **Mem** icon to access the Preset Screen.



3. Touch the preset number (P1 through P6) in which you would like to store the current channel (or touch **Exit** to cancel and close the menu). The channel is displayed at the top of the menu. The preset number will appear highlighted. The channel will be displayed on the front panel of the tuner screen.

### Recalling a Channel

1. Select a band (if needed).
2. Touch an on-screen preset button to select the corresponding stored channel.

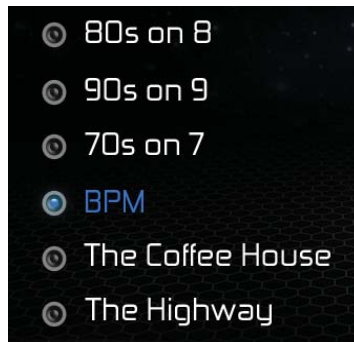



## Searching for a Channel

### Search by Channel

To search by channel:

1. On the SiriusXM® menu page, touch the **Category/Channel** icon (if needed) to select **Channel**.
2. Touch **List** to go to the Channel Screen. The following screen appears.



3. Touch a channel to tune to that channel.

### Search by Category

Categories group music by type such as jazz, rock, classical, etc. To search by category:

1. On the SiriusXM® menu page, touch the **Category/Channel** icon (if needed) to select **Category**.
2. Touch **List** to go to the Category Screen. The following screen appears.

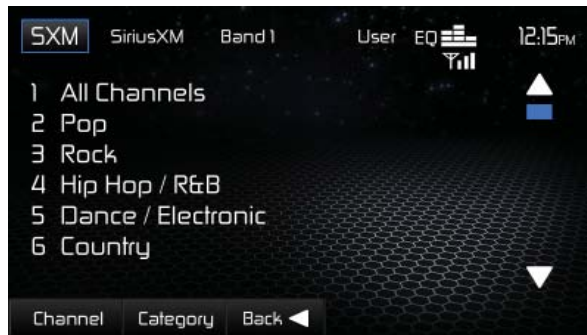

3. Touch a category item. A channel list screen appears.
4. Touch a channel to tune to that channel.



## Parental Lock Options

The SXM Parental Lock Menu allows you to block access to individual channels or mature channels.

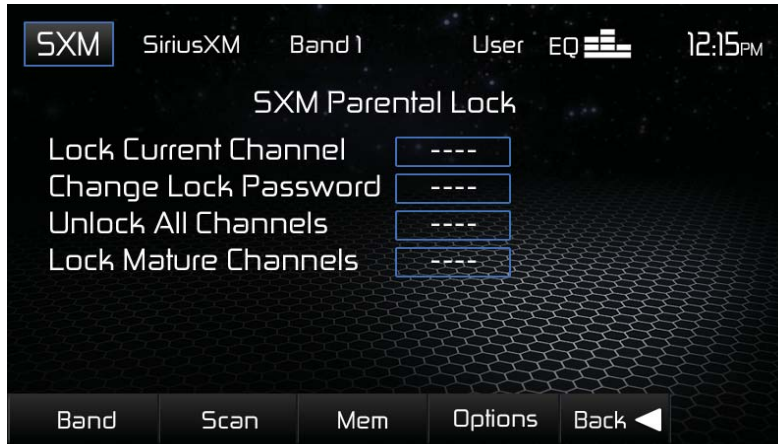

### **Lock Current Channel:**

Individual channels may be locked. The **Lock Current Channel** option allows you the ability to lock a certain channel. Locking does not allow the SiriusXM® tuner to access that channel's audio or metadata.

#### **To lock a channel:**

1. Tune to a channel.
2. Touch the **Options** icon to enter the SXM Parental Lock Menu.
3. Touch the blue box adjacent to **Lock Current Channel**.
4. Enter your password using the on-screen number pad.
5. Touch the check mark to enter your password. The channel is now locked.

### **Change Lock Password:**

The **Change Lock Password** option allows you to change the password from the default or current custom password to another password.

**NOTE: The default password is 1, 2, 3, 4.**

#### **To change a password:**

1. Touch the **Options** icon to enter the SXM Parental Lock Menu.
2. Touch the blue box adjacent to **Change Lock Password**.
3. Enter the old password using the on-screen number pad and touch the check icon.
4. Enter the new password using the on-screen number pad and touch the check icon. The new password is set.

**NOTE: The "Master Unlock" code is 8, 8, 8, 8. If you lose or forget your custom password, use this code to change a password.**



**Unlock All Channels:**

The **Unlock All Channels** option unlocks all (individual and mature) locked channels.

**To unlock all channels:**

1. Tune to a channel that is not locked (for example Channel 1, preview channel).
2. Touch the **Options** icon to enter the SXM Parental Lock Menu. The **Unlock All Channels** choice will be enabled.
3. Touch the blue box adjacent to **Unlock All Channels**.
4. Enter your password using the on-screen number pad.
5. Touch the check mark to enter your password. The channels are now unlocked.

When the global "Mature Lock" is enabled, a mature channel can be temporarily unlocked ONLY until the key is cycled. Once the radio is powered on again, the channel will be locked again.

This mode is useful for listening to mature/adult content on a temporary basis, allowing you to listen on a channel-by-channel basis without having to disable the global "Mature Lock" of all mature channels.

If a channel is locked and is labeled "Mature" by SXM then the **Unlock All Channels** option is changed to **Unlock Current Channel** to allow you to temporarily unlock a mature channel.

**To unlock a mature channel:**

1. Touch the **Options** icon to enter the SXM Parental Lock Menu. The **Unlock Current Channel** choice will be enabled.
2. Touch the blue box adjacent to **Unlock Current Channel**.
3. Enter your password using the on-screen number pad.
4. Touch the check mark to enter your password. The channel is now unlocked.

**Lock Mature Channels:**

SiriusXM® attaches a label to channels with adult content. The radio recognizes these channels as "Mature". The **Lock Mature Channels** option allows you to lock out channels with "Mature" labels. These channels will still appear in the channel listing (with a lock symbol), but will not be tunable unless the parental lockout password is correctly entered.

**To lock mature channels:**

1. Touch the **Options** icon to enter the SXM Parental Lock Menu.
2. Touch the blue box adjacent to **Lock Mature Channels**.
3. Enter your password using the on-screen number pad.
4. Touch the check mark to enter your password. The mature channels are now locked.

**VM9215BT**



---

## **REAR CAMERA OPERATION (if equipped)**

This unit is "camera ready." Before accessing any camera features, you must install a rear video camera.

When the camera is not installed and the function is accessed by the gear selector being placed in reverse or by the unit's menu, the message "VIDEO NOT DETECTED" will appear, indicating the function is not available.

When the camera is installed, the rear view image of what is behind the vehicle will appear when the vehicle is placed in reverse gear. When leaving reverse gear, the unit displays the previous screen.

The rear camera image can be adjusted from Normal to Mirror using the "Setup" menu ("see Hardware Sub-menu Features").\*



**TROUBLESHOOTING**

**Table 9: Troubleshooting**

<b>Problem</b>	<b>Cause</b>	<b>Corrective Action</b>
<b>GENERAL</b>		
Unit will not power on	Radio Fuse blown	Install new fuse with correct rating
	Car battery fuse blown	Install new fuse with correct rating
	Illegal operation	Press the RESET button located in the bottom right corner of the front panel
No/low audio output	Improper audio output connection	Check wiring and correct
	Volume set too low	Increase volume level
	Improper "MUTE" connection	Review wiring diagram and check "MUTE" connection
	Speakers damaged	Replace speakers
	Heavily biased volume balance	Adjust the channel balance to the center position
	Speaker wiring is in contact with metal part of car	Insulate all speaker wiring connections
Poor sound quality or distortion	Pirated disc is in use	Use original copy
	Speaker power rating not compatible with unit	Connect proper speakers
	Speaker is shorted	Check speaker contact
Unit resets itself when engine is off	Incorrect connection between ACC and positive battery wire	Check wiring and correct
<b>TFT MONITOR</b>		
Monitor does not open automatically	TFT Auto Open is turned off	Turn TFT Auto Open on
No image	Incorrect connection to parking brake wire	Check wiring and correct
	Parking brake is not engaged	Stop vehicle in safe place and apply parking brake

# VM9215BT



<b>Problem</b>	<b>Cause</b>	<b>Corrective Action</b>
Flashing image or interference appears on screen	DVD is not compatible with current TV system settings	Change setup to accommodate disc
	Improper video signal connections	Check wiring and correct connections
Prolonged image or improper height/width ratio display	Improper aspect ratio setup	Use correct aspect ratio setting
Monitor stops at incorrect position	Moving path is blocked	Press <b>OPEN</b> key to restart monitor movement
<b>TUNER</b>		
Weak station searching	Auto antenna is not fully extended	Connect the auto antenna control cable properly
	Auto antenna not properly connected	Connect the auto antenna control cable properly
	LOCAL function is activated	Turn LOCAL function off
<b>DISC</b>		
Cannot insert disc	Disc already inside unit	Eject current disc and insert new one
Image blurred, distorted, or dark	Disc is illegally copied	Use original disc
Disc does not play back	Disc is warped or scratched	Use disc in good condition
	Disc is dirty or wet	Clean disc with soft cloth
	Laser pickup is dirty	Clean laser pickup with cleaning disc
	Incompatible disc is used	Use compatible disc
	Disc rating exceeds Parental Lock rating limit	Change Parental Lock settings to lower restriction limit
	Disc region code is not compatible with unit	Use disc with proper region code
	Disc is inserted upside down	Insert disc with label side up



## VM9215BT

<b>Problem</b>	<b>Cause</b>	<b>Corrective Action</b>
PBC cannot be used during VCD playback	PCB is not available on the disc	
No repeat or searching while playing VCD	PCB is on	Turn PCB off
<b>MP3</b>		
Interruption occurred during playback	Disc is dirty or scratched	Clean disc or replace
	File is damaged/bad recording	Recreate disc with good files



## Error Messages

**Table 10: Error Messages**

Message Displayed	Cause	Corrective Action
Loading	Disc is being read	
No Disc	Disc is dirty	Clean disc with soft cloth
	Disc is upside down	Insert disc with label side up
	Disc not present in loading compartment	Insert disc
Bad Disc	Disc is dirty	Clean disc with soft cloth
	Disc is upside down	Insert disc with label side up
Unknown disc	Disc format is not compatible with this unit	
Region Error	DVD is not compatible with region code of unit	
Error	Illegal mechanism operation	Press <b>EJECT</b> key for 5 seconds to reset loading mechanism



**VM9215BT**

---

## **CARE AND MAINTENANCE**

1. Use only a clean silicone cloth and neutral detergent to clean the front panel or monitor. A rough cloth and non-neutral detergent (such as alcohol) may result in scratching or discoloration.
2. Do not get water or cleaning fluids on the unit.
3. If the temperature inside the player gets too hot, a protective circuit automatically stops play of the disc. If this occurs, allow the unit to cool before operating the player again.
4. Never insert anything other than a 5" (12 cm) compact disc into the player as the mechanism can be damaged by foreign objects.
5. Do not attempt to use a 3" (8 cm) CD-Single disc in this unit, either with or without an adaptor, as damage to the player and/or disc may occur. Such damage is not covered by the Warranty on this product.
6. The CD player may not operate properly in extreme hot or cold. If such conditions occur, allow the interior of the vehicle to reach a normal temperature before using player.
7. When the vehicle warms up during cold weather or under damp conditions, condensation may appear on the TFT panel. Should this occur, the screen will not operate properly until the moisture has evaporated.
8. We suggest you use a cleaning disc in this unit more frequently than in the unit in your home due to the environmental conditions of the vehicle.



# VM9215BT



## SPECIFICATIONS

### **DVD/CD Player**

Compatible Disc Media: DVD + R / RW (Single and Dual Layer) and CD-R / RW  
Compatible Media Formats: CD-DA, MP3, WMA, VCD, SVCD, Xvid, AVI, MPEG 1/2  
Signal to Noise Ratio: >95dBA  
Dynamic Range: >95dB  
Frequency Response: 20Hz to 20 kHz, -3dB  
Channel Separation: > 60dB @ 1 kHz  
D/A Converter: High performance 24-bit / 192 kHz sample rate, Multi-Bit Sigma-Delta Modulator

### **Video**

Format: NTSC, PAL (auto-detection)  
Output: 1Vp-p (75-ohm)  
Input: 1Vp-p (75-ohm)

### **FM Tuner**

Tuning Range: 87.5MHz - 107.9MHz  
Mono Sensitivity (-30dB): 9dBf  
Quieting Sensitivity (-50dB): 15dBf  
Alternate Channel Selectivity: 70dB  
Signal to Noise Ratio @ 1 kHz: 58dB  
Image Rejection: 80dB Stereo Separation @ 1 kHz: >30dB  
Frequency Response: 30Hz - 15 kHz, -3dB

### **AM Tuner**

Tuning Range: 530 kHz - 1720 kHz  
Sensitivity (-20dB): 15uV  
Signal to Noise Ratio @ 1 kHz: 50dB  
Image Rejection: 60dB  
Frequency Response: 50Hz - 2 kHz, -3dB



## VM9215BT

### **Monitor**

Screen Size: 7.0" (Measured diagonally), 16:9 Widescreen  
Screen Type: TFT Liquid Crystal Display (LCD) active matrix  
Resolution: 336,960 sub pixels, 1440 (W) X 234 (H)

### **General**

Auxiliary Input impedance: 10k  
Power Supply: 11 to 16VDC, negative ground  
Power Antenna (Blue): 500mA max, current limited protection  
Amplifier Remote (Blue/White): 500mA max, current limited protection  
Operating Temperature: -20C ~ 65C  
Fuse: 15-amp, mini ATM type  
DIN chassis dimensions: 7" X 7" X 2" (178mm x 178mm x 50mm)

### **CEA Power Ratings**



Power Output: 13 Watts RMS x 4 channels into 4-Ohms @ < 1% THD+N  
Signal to Noise Ratio: 70dBA below reference (Reference: 1 Watt, 4-Ohms)  
Frequency Response: 20 Hz - 20 kHz, -3dB. (Aux Input used as reference input)  
Reference Supply Voltage: 14.4VDC

\*Specifications subject to change without notice.

**VM9215BT**



---

**COMMON REPLACEMENT PARTS**

Owners Manual and Install Manual	30613620
Wire Harness	30313620
External Microphone	30443240
Remote Control	30713620
Trim Ring	30413580
Sleeve	30113620
Parking Wire	38213030
Hardware Bag	30513030



**Audiovox Electronics Corporation**  
**Hauppauge, NY 11788**  
**Technical Assistance: 1-800-323-4815**  
**[www.mobile.jensen.com](http://www.mobile.jensen.com)**  
**© 2012 Audiovox**  
**Printed in China**

**128-9052**