

# ENERGY



## ENERGY POWER® BASE

OWNER'S MANUAL

↑ TRIM LINE ↓

↑ TRIM LINE ↓

↓ TRIM LINE ↓

↓ TRIM LINE ↓



## WHAT'S INSIDE

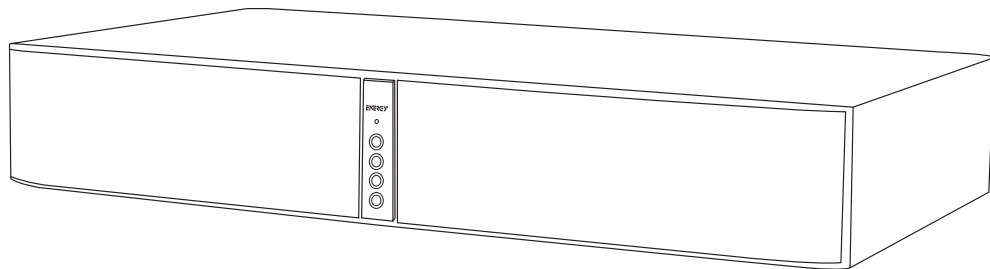

Energy Power® Base

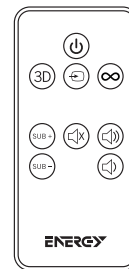

Remote

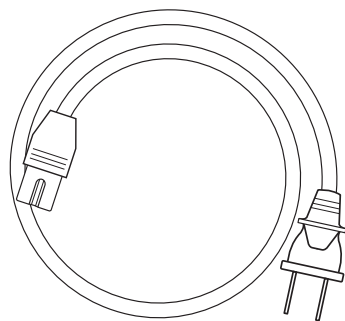

AC Power Cord

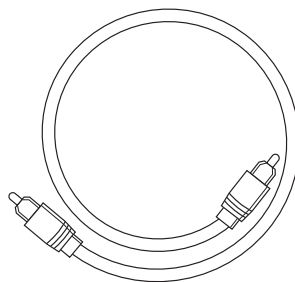

Digital Optical Cable

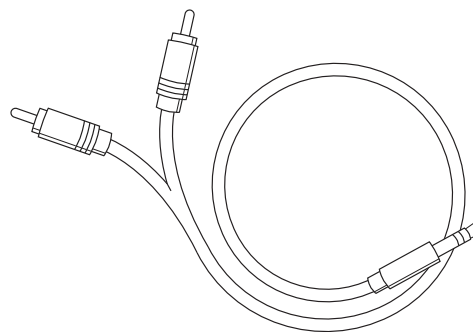

3.5mm to Dual RCA Cable

↑ TRIM LINE ↓

↑ TRIM LINE ↓

↓ TRIM LINE ↓

↓ TRIM LINE ↓

## DIGITAL OPTICAL CONNECTION (PREFERRED - IF TV HAS NO OPTICAL OUT SEE NEXT PAGE)

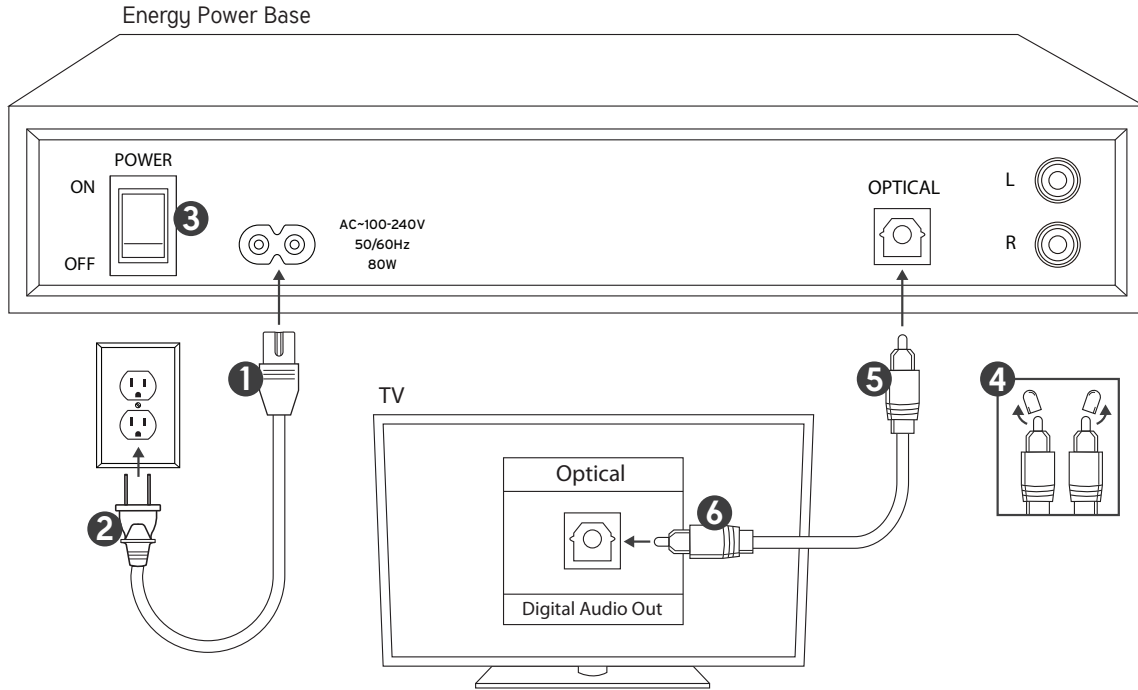

## 3.5mm TO DUAL RCA ANALOG CONNECTION (IF TV HAS NO HEADPHONE OUT SEE NEXT PAGE)

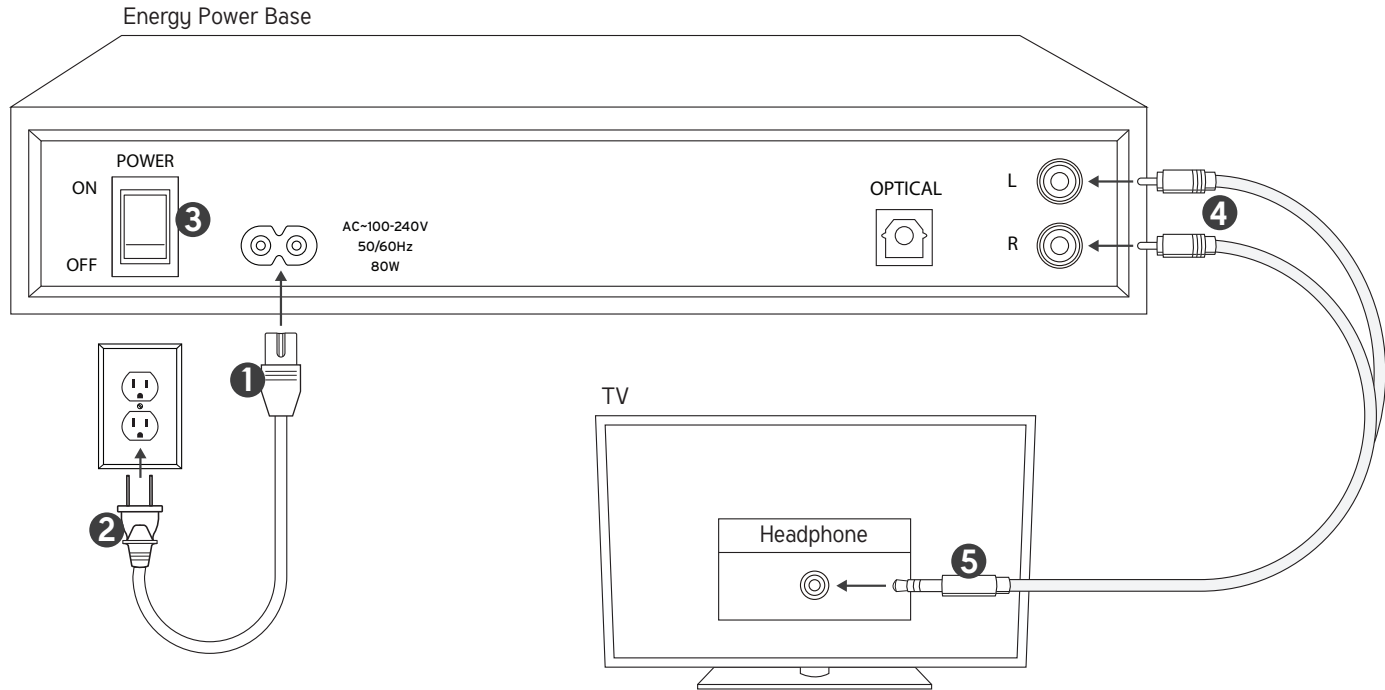

# DUAL RCA TO DUAL RCA ANALOG CONNECTION

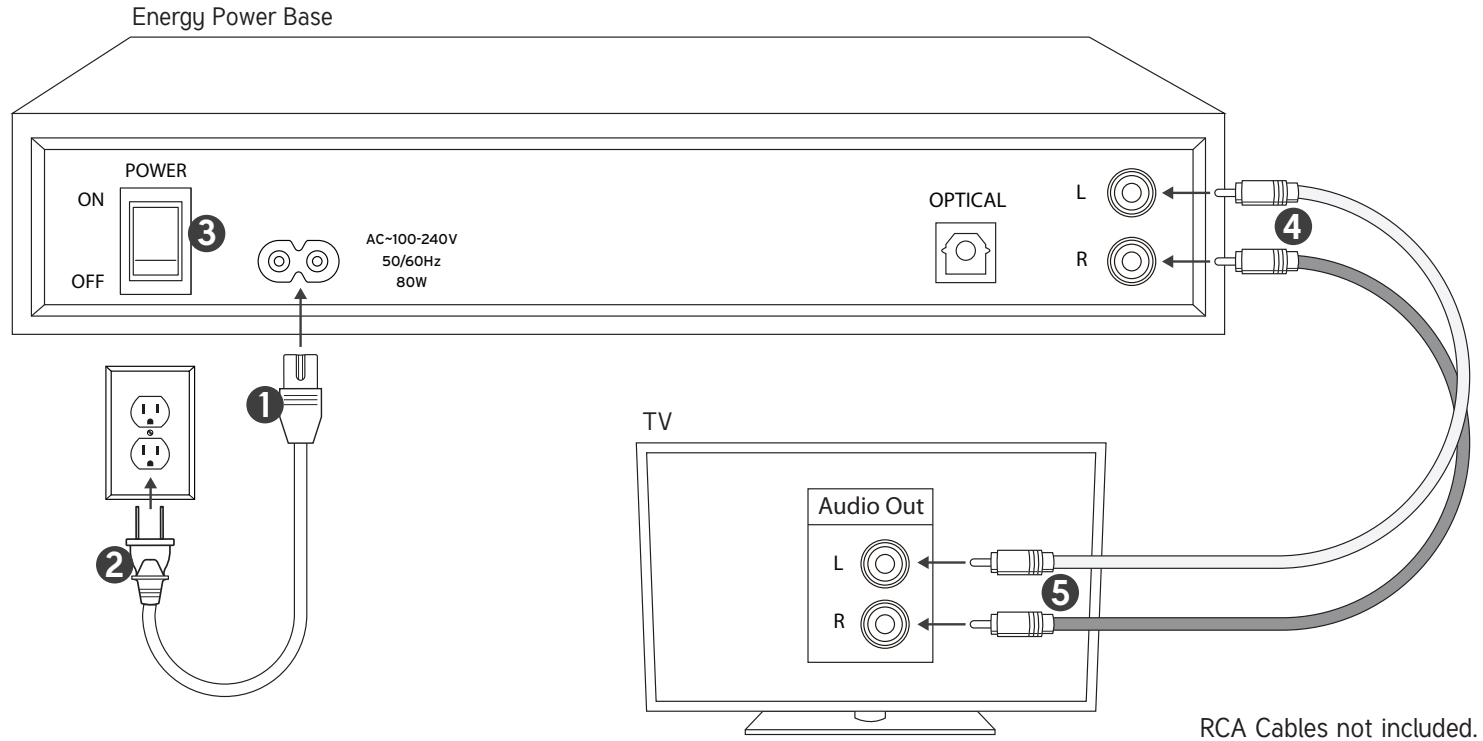

## TV REMOTE PROGRAMMING

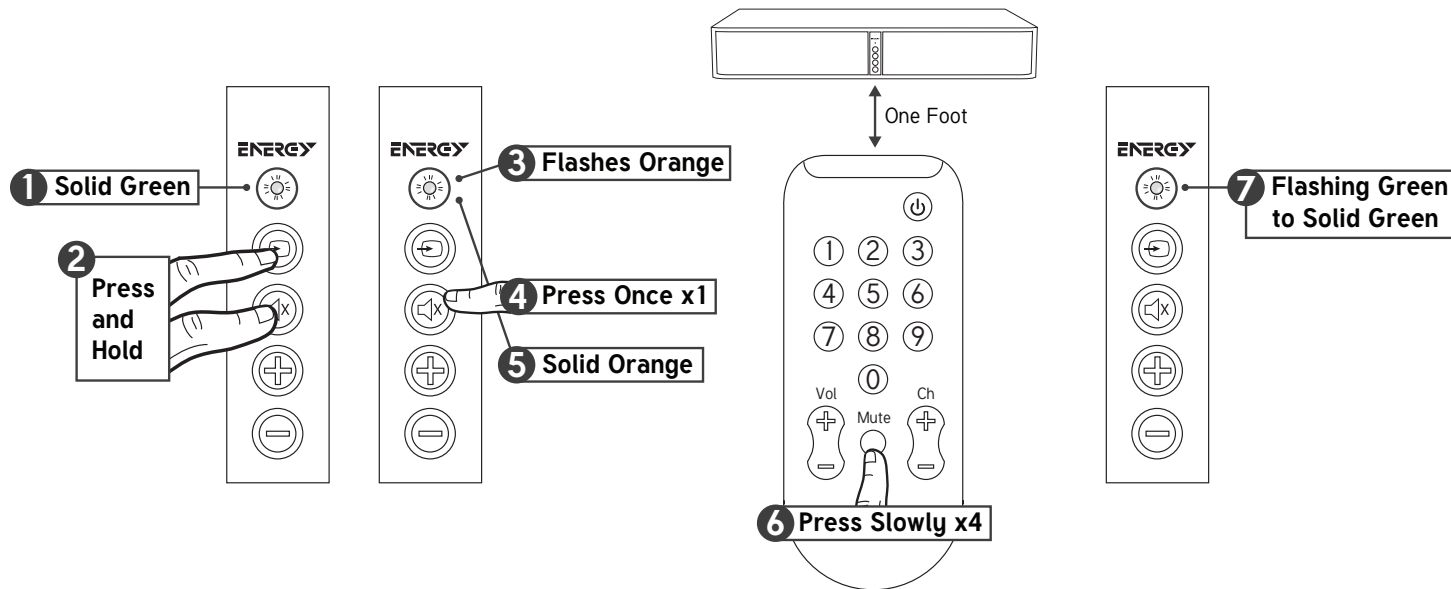

To program Volume Up and Volume Down buttons repeat the steps shown and replace steps 4 and 6 with the button you want to program.

If you are trying to program a cable/satellite box remote or other universal remote without success, please try programming your TV or Cable Box remote instead.

## BLUETOOTH® WIRELESS TECHNOLOGY

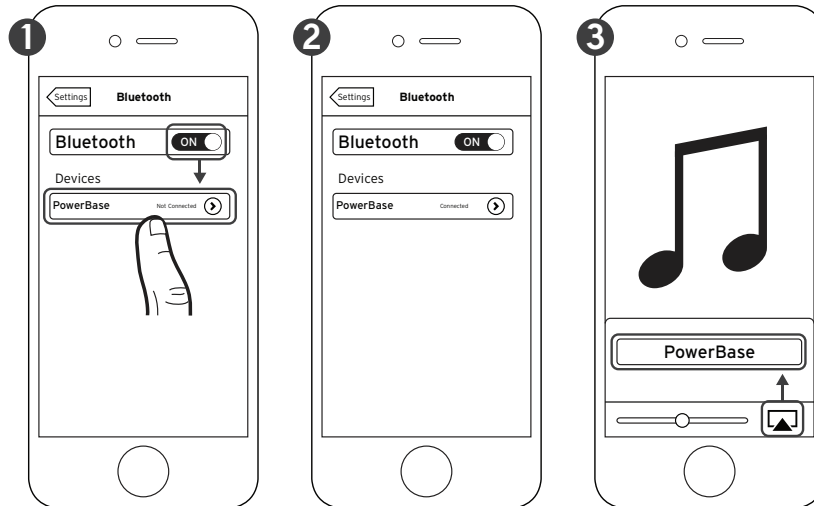

\*Example only. Your device may differ.

You can pair a device equipped with *Bluetooth* wireless technology at any time by activating it on your device.

Once your device equipped with *Bluetooth* wireless technology is paired, the Energy Power Base will automatically switch to the *Bluetooth* wireless technology input (SOLID BLUE LIGHT) and you can stream your music. If you switch inputs on the Energy Power Base, the *Bluetooth* wireless technology connection will automatically be terminated.

You must disconnect your device before pairing another device equipped with *Bluetooth* wireless technology by either:

- Pressing and holding the SOURCE button on the Energy Power Base control panel 3 seconds
- Turning off *Bluetooth* wireless technology on the paired device
- Pressing the *Bluetooth* wireless technology button ( $\infty$ ) on the Energy Power Base remote



# BUTTONS

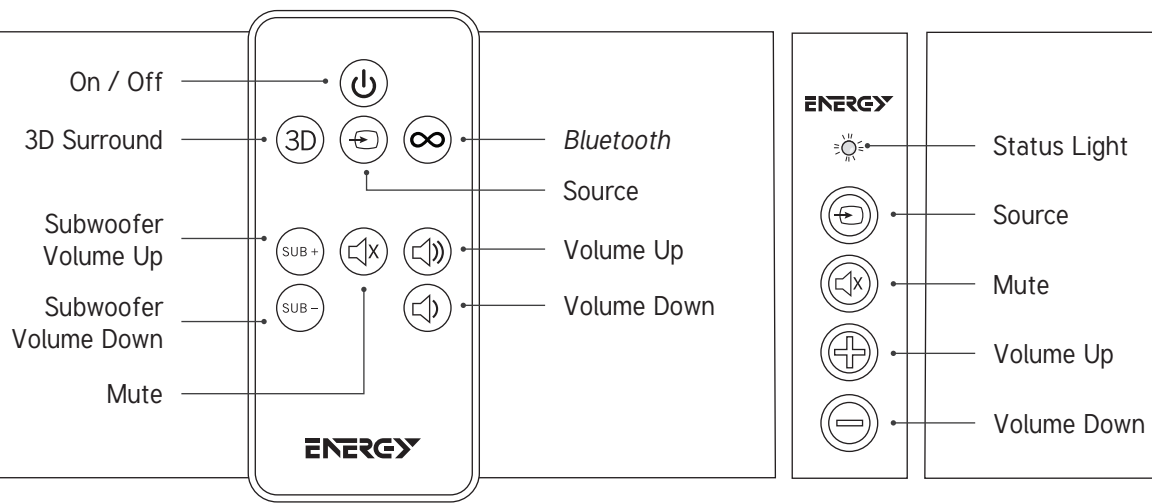

## STATUS LIGHTS

---

**SOLID RED** Power Off (Standby Mode)

**SOLID GREEN** Power On, Source is Optical Input

**SOLID ORANGE** Power On, Source is Analog Input

**SOLID BLUE** Power On, Source is Paired  
*Bluetooth* device

**FLASHES GREEN /  
ORANGE / BLUE** Volume Up, Volume Down, Subwoofer  
Volume Up or Subwoofer Volume  
Down is pushed

**FLASHES GREEN ONCE** 3D Surround turned on

**FLASHES RED ONCE** 3D Surround turned off

**FLASHES BLUE QUICKLY** Waiting to pair with *Bluetooth*  
device

**FLASHES PURPLE SLOWLY** Energy Power Base decoding  
Dolby Digital

## STANDBY MODE

---

You do not need to turn off the Energy Power Base, just turn off your TV (or Satellite / Cable Box) and the Energy Power Base will automatically go into standby mode in approximately 10 minutes.

Standby mode is indicated by a red status light on the front panel. When your TV (or Satellite / Cable Box) is turned back on the Energy Power Base will automatically turn on again.

## PLACEMENT

**TV must weigh less than 80 lbs (36kg)**

**TV base must be smaller than  
23" x 12" (58cm x 30cm)**

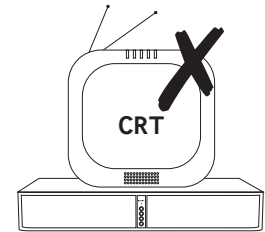
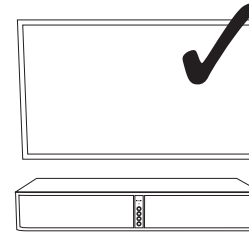
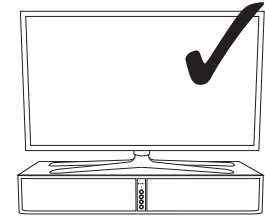
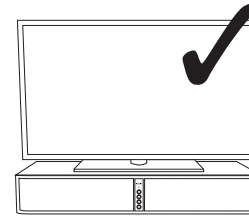
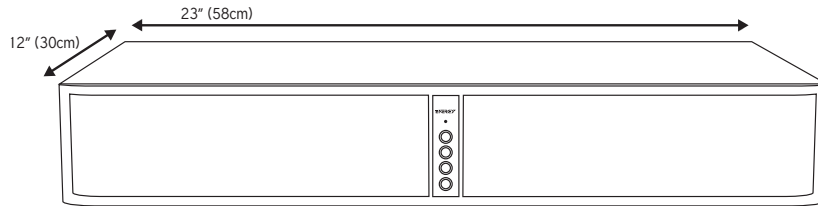

**Make sure the rear of the Energy Power Base is at least one inch away from a back wall and there is at least one inch clearance around the top and sides of the Energy Power Base for ventilation.**

## TURN OFF TV SPEAKERS

---

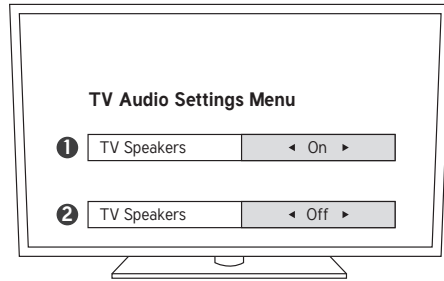

(Recommended)

OR

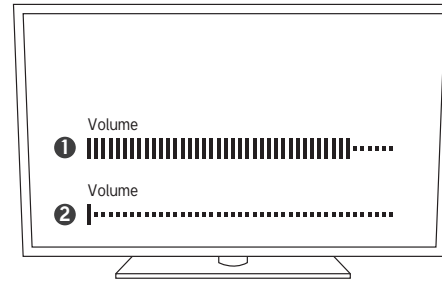

## CARE AND CLEANING

---

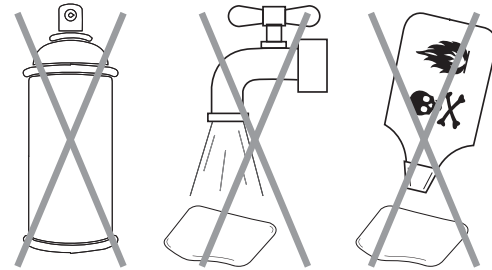
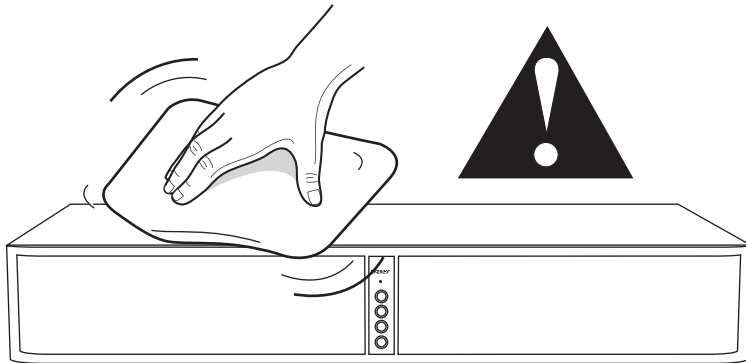

## TROUBLESHOOTING

---

### Energy Power Base will not Power On

- Is it plugged into a live outlet?
- Is the rear power switch on?

### No sound

- Is it plugged into a live outlet and the rear power switch is on?
- Are all cables from the TV/Cable Box/Satellite Box plugged in tightly?
- If the optical cable is being used were the clear plastic caps from both ends removed before connecting?
- Is the volume turned up?
- Is standby off (no SOLID RED status light)?
- Is the source input correct?
- Turn off the rear power switch, then back on.

### TV/Cable/Satellite Box Remote will not program

- Carefully follow all remote programming instructions.
- Carefully go through the remote programming again, but **use the original remote that comes with the TV**. You DO NOT need to then reprogram using your cable/satellite/universal remote control.
- Program the original TV remote to the Energy Power Base (if original is a different one), then use the universal remote without programming it.
- You may need to repeat programming of a function in some cases.
- There may be some cases the Energy Power Base is unable to learn certain remote codes.

### Bluetooth Wireless Technology does not work

- Is the device paired to the Energy Power Base?
- Move your device closer to the Energy Power Base and make sure it is paired.
- If the status light blinks RED while attempting to pair, start the pairing process over.

*For Questions, contact Energy Customer Service:  
In the United States: 1-866-441-8208*



Manufactured under license from Dolby Laboratories. Dolby and the double-D symbol are registered trademarks of Dolby Laboratories.

The *Bluetooth*® word mark and logos are registered trademarks owned by *Bluetooth* SIG, Inc. and any use of such marks by Klipsch Group, Inc. is under license.

## COMPOSANTS INCLUS

---

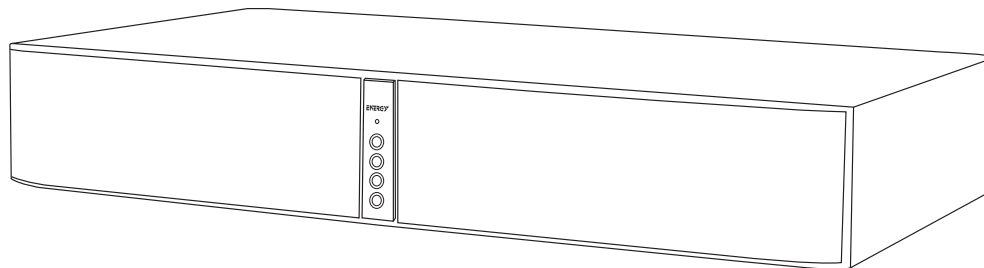

Energy Power® Base

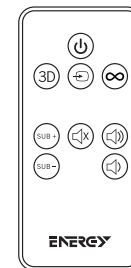

Télécommande

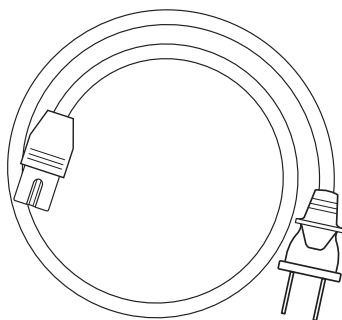

Cordon d'alimentation c.a.

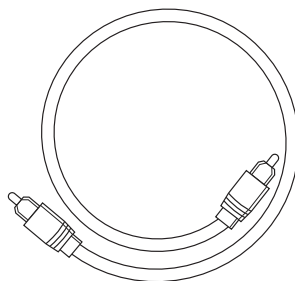

Câble optique numérique

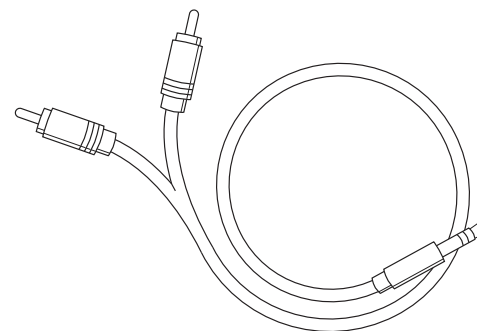

Câble 3,5 mm vers double fiche RCA

# CONNEXION OPTIQUE NUMÉRIQUE (RECOMMANDÉE - SI LE TÉLÉVISEUR N'A PAS DE SORTIE OPTIQUE, VOIR PAGE SUIVANTE)

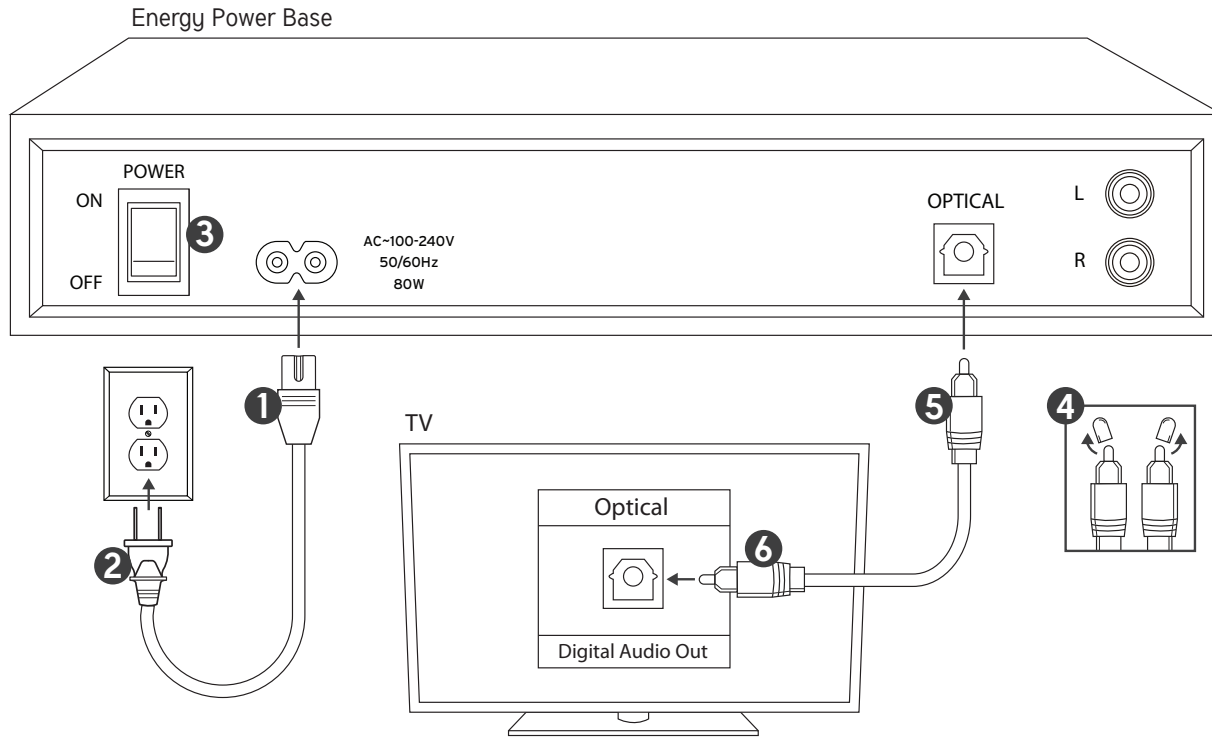

## CONNEXION ANALOGIQUE 3,5 MM VERS DOUBLE FICHE RCA

(SI LE TÉLÉVISEUR N'A PAS DE SORTIE POUR CASQUE D'ÉCOUTE, VOIR PAGE SUIVANTE)

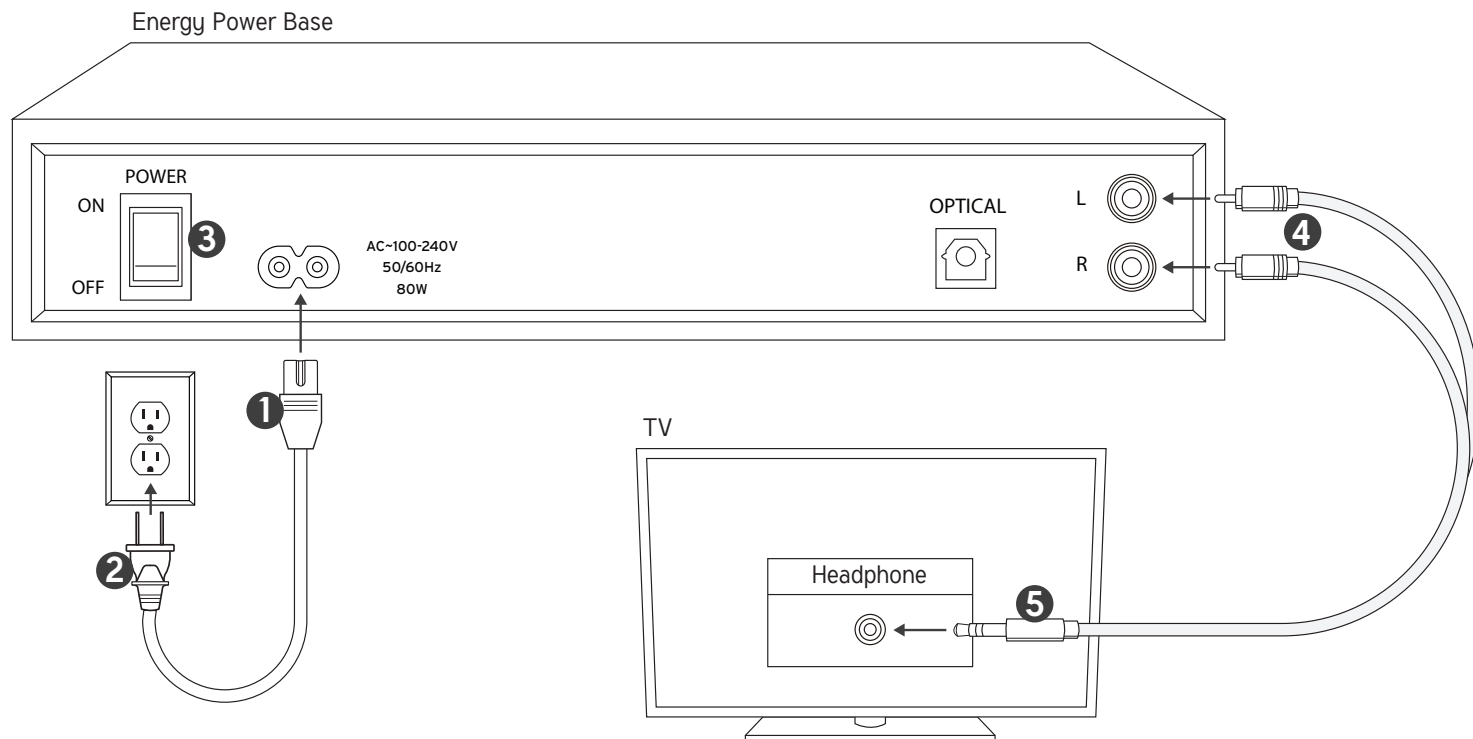



## CONNEXION ANALOGIQUE DOUBLE FICHE RCA VERS DOUBLE FICHE RCA

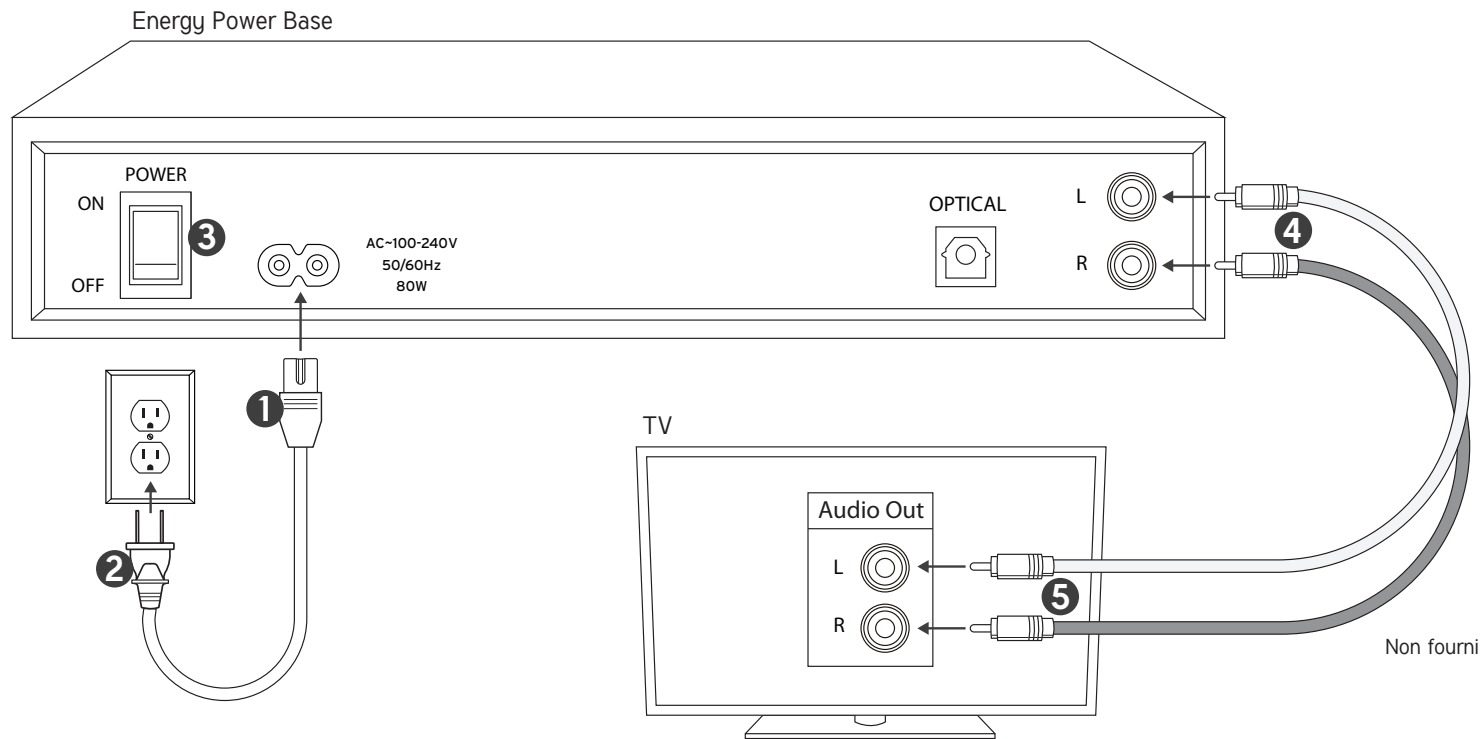

## PROGRAMMATION À DISTANCE DU TÉLÉVISEUR

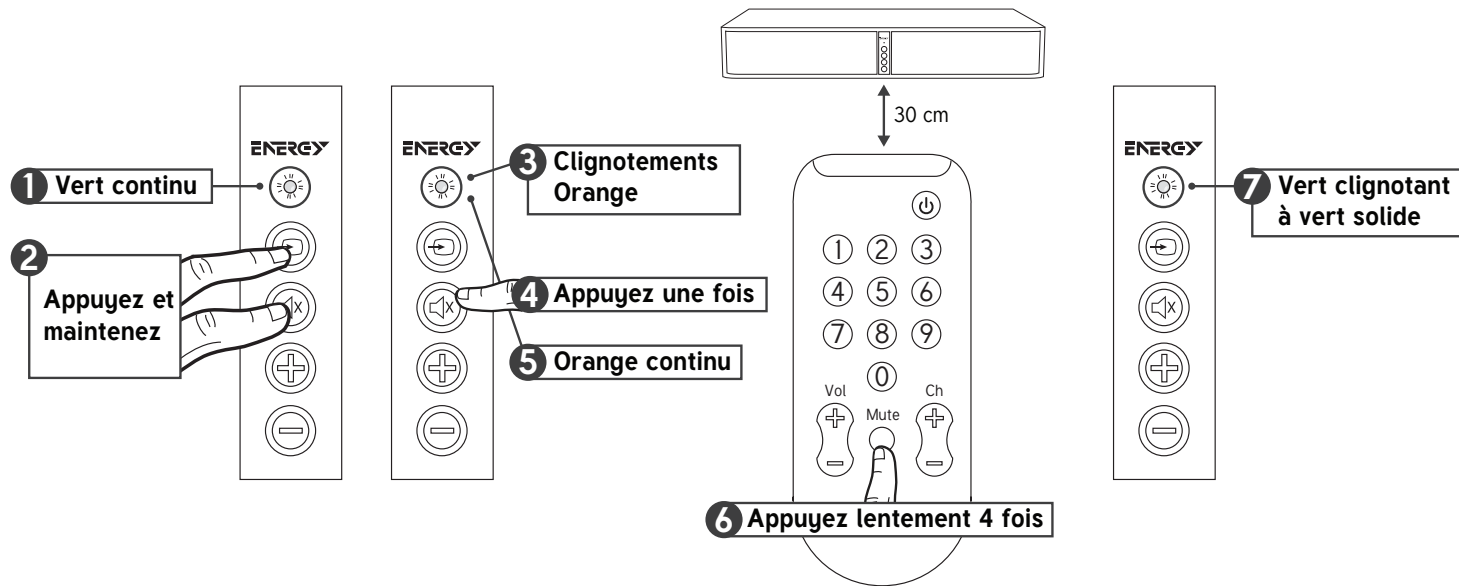

Pour régler les boutons pour augmenter et réduire le volume, répétez les étapes indiquées et remplacez les étapes 4 et 6 par le bouton que vous souhaitez programmer.

Si vous n'arrivez pas à programmer une télécommande de décodeur satellite ou de câblodistribution ou une autre télécommande universelle, essayez de programmer la télécommande de votre téléviseur ou de votre décodeur de câblodistribution.

## TECHNOLOGIE SANS FIL *BLUETOOTH*<sup>®</sup>

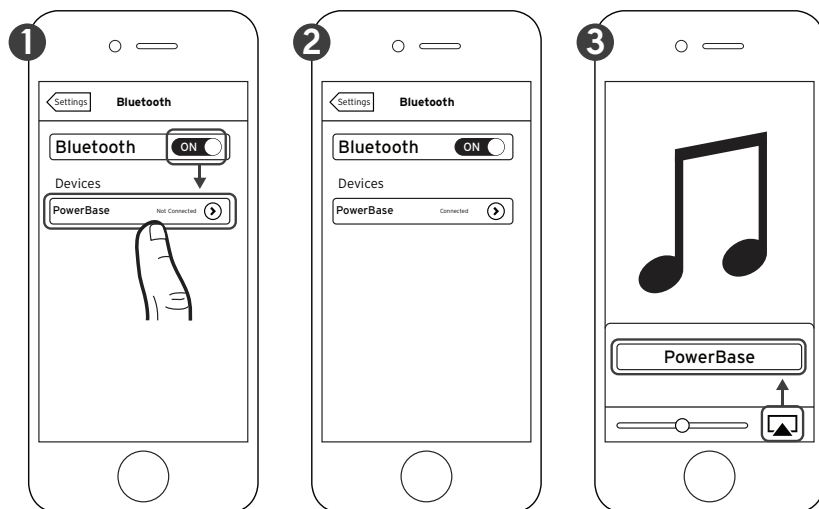

\*À titre d'exemple seulement. Votre appareil peut être différent.

Vous pouvez appairer un appareil *Bluetooth* à tout moment en activant *Bluetooth* sur votre appareil.

Une fois l'appareil *Bluetooth* appairé, l'Energy Power Base bascule automatiquement sur l'entrée *Bluetooth* (VOYANT BLEU CONTINU) et vous pouvez procéder à la diffusion de votre musique. Si vous changez d'entrée sur l'Energy Power Base, la connexion *Bluetooth* se termine automatiquement.

Vous devez déconnecter un appareil *Bluetooth* avant d'appairer un autre appareil *Bluetooth*, en procédant suivant l'une de ces méthodes :

- Appuyez sur le bouton **SOURCE** sur le panneau de commande de l'Energy Power Base et maintenez-le enfoncé pendant 3 secondes
- Désactivez *Bluetooth* sur le dispositif appairé.
- Appuyez sur le bouton *Bluetooth* sur la télécommande de l'Energy Power Base

# TOUCHES

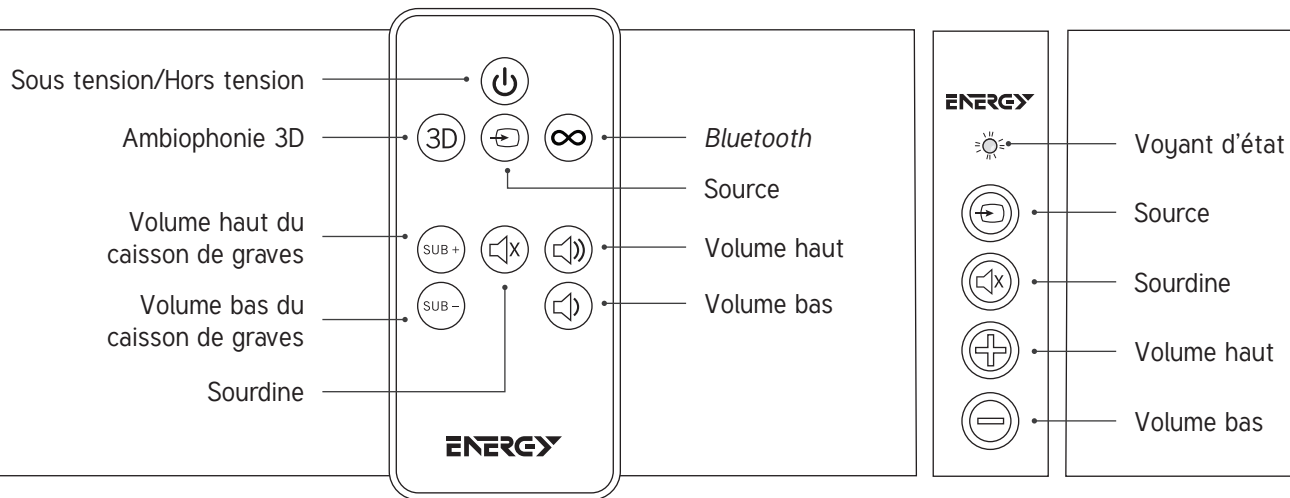

## VOYANTS D'ÉTAT

---

<b>ROUGE CONTINU</b>	Hors tension (mode Veille)	<b>CLIGNOTE UNE FOIS EN VERT</b>	Ambiophonie 3D activée
<b>VERT CONTINU</b>	Sous tension, la source est l'entrée optique	<b>CLIGNOTE UNE FOIS EN ROUGE</b>	Ambiophonie 3D désactivée
<b>ORANGE CONTINU</b>	Sous tension, la source est l'entrée analogique	<b>CLIGNOTE RAPIDEMENT EN BLEU</b>	En attente d'appariement avec un appareil <i>Bluetooth</i>
<b>BLEU CONTINU</b>	Sous tension, la source est un appareil apparié <i>Bluetooth</i>	<b>CLIGNOTE LENTEMENT EN VIOLET</b>	Energy Power Base en cours de décodage de Dolby Digital
<b>CLIGNOTE EN VERT / ORANGE / BLEU</b>	Volume haut, volume bas, volume haut du caisson de graves ou volume bas du caisson de graves est activé		

## MODE VEILLE

---

Vous n'avez pas à mettre l'Energy Power Base hors tension. Il suffit d'éteindre votre téléviseur (ou votre décodeur satellite ou de câblodistribution) et l'Energy Power Base passe alors automatiquement en mode Veille au bout d'environ 10 minutes.

L'activation du mode Veille est indiquée par un voyant d'état rouge sur le panneau avant. Quand votre téléviseur (ou votre décodeur satellite ou de câblodistribution) est remis en marche, l'Energy Power Base passe automatiquement sous tension.

## PLACEMENT

**Le poids du téléviseur doit être inférieur à 36 kg**

**La taille de la base du téléviseur doit être inférieure à 58 cm x 30 cm**

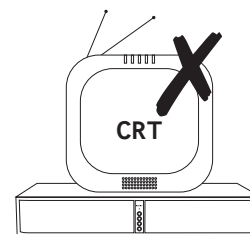
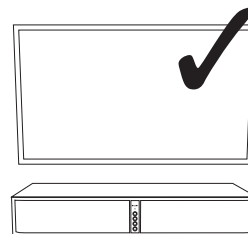
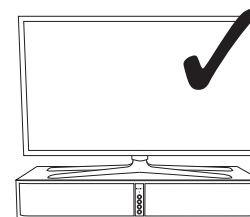
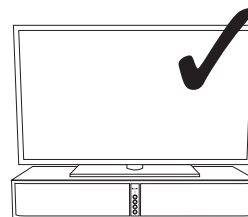
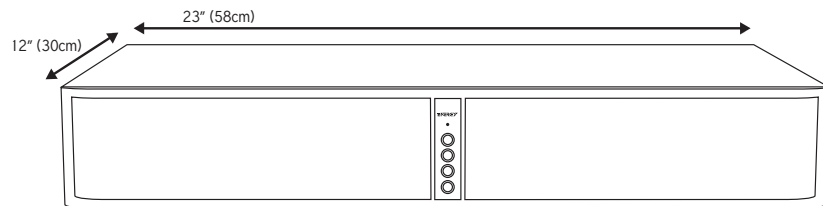

**Assurez-vous que l'Energy Power Base a un dégagement d'au moins 2,5 cm par rapport au mur arrière ainsi que sur le haut et sur les côtés pour permettre la ventilation.**

## MISE HORS TENSION DES HAUT-PARLEURS DU TÉLÉVISEUR

---



(Recommandé)

OU

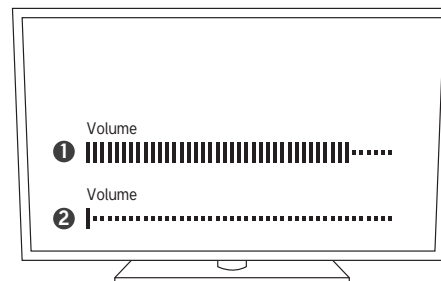

## ENTRETIEN ET NETTOYAGE

---

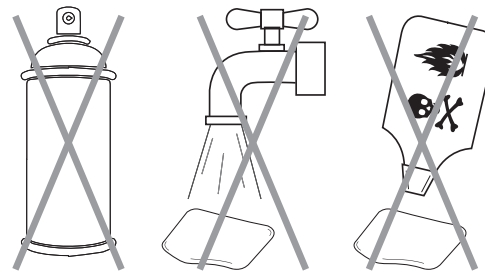
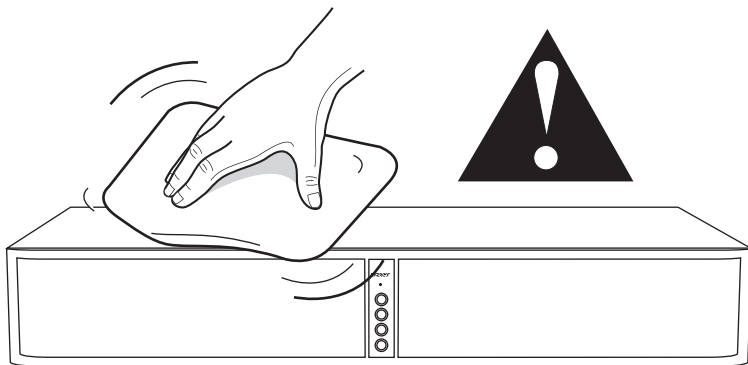

## EN CAS DE DIFFICULTÉ

---

### L'Energy Power Base ne passe pas sous tension

- Est-elle branchée dans une prise sous tension alimentée ?
- L'interrupteur arrière est-il sur la position de mise sous tension ?

### Aucun son

- Est-elle branchée dans une prise sous tension alimentée et l'interrupteur arrière de l'alimentation principale est-il sur la position de mise sous tension ?
- Tous les câbles du téléviseur/décodeur satellite ou câblodistribution sont-ils insérés à fond ?
- Si le câble optique est utilisé, les capuchons en plastique à l'extrémité du câble ont-ils été retirés ?
- Le volume est-il réglé à un niveau audible ?
- Le mode veille est-il désactivé (pas de voyant d'état ROUGE CONTINU) ?
- La source d'entrée est-elle correcte ?
- Faites passer l'interrupteur d'alimentation arrière sur la position hors tension, puis remplacez-le sur la position de mise sous tension.

### La télécommande du téléviseur/du décodeur satellite ou de câblodistribution ne se programme pas

- Suivez strictement toutes les instructions de programmation.
- Revoyez avec attention la programmation à distance mais utilisez la télécommande d'origine qui est livrée avec le téléviseur. VOUS N'AVEZ PAS BESOIN de reprogrammer ensuite en utilisant votre télécommande de câblodistribution/satellite/universelle.
- Programmez la télécommande d'origine du téléviseur par rapport à

l'Energy Power Base (si celle d'origine est différente), puis utilisez la télécommande universelle sans la programmer.

- Il peut s'avérer nécessaire de répéter la programmation d'une fonction dans certains cas.
- Il est possible que, dans certains cas, l'Energy Power Base ne puisse pas lire les codes de certaines télécommandes.

### La transmission *Bluetooth* ne fonctionne pas

- L'appareil *Bluetooth* est-il apparié à l'Energy Power Base ?
- Rapprochez l'appareil *Bluetooth* de l'Energy Power Base et assurez-vous qu'il est apparié.
- Si le voyant d'état clignote en ROUGE lorsque vous tentez d'apparier, recommencez le processus d'appariement depuis le début.

*Pour toute question, contactez le service client Energy :*

*Aux États-Unis : 1-866-441-8208*



*Fabrication sous licence de Dolby Laboratories. Dolby et le symbole double-D sont des marques de commerce déposées de Dolby Laboratories.*

*La marque et les logos du mot Bluetooth® sont des marques de commerce déposées, propriétés de Bluetooth SIG, Inc. et l'utilisation de ces marques par Klipsch Group, Inc. fait l'objet d'une licence.*





## CONTENIDO

---

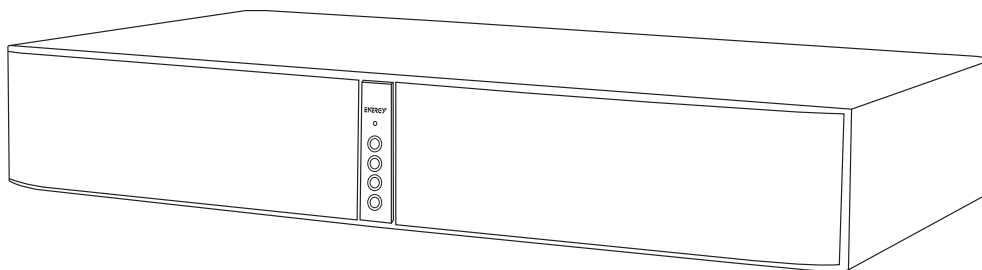

Energy Power® Base

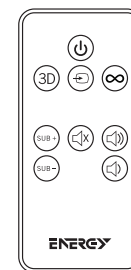

Control remoto

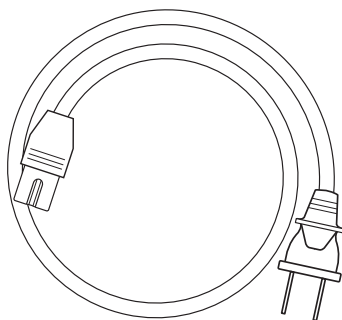

Cordón de alimentación de corriente alterna (CA)

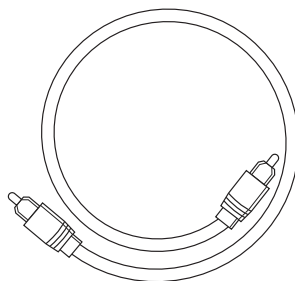

Cable óptico digital

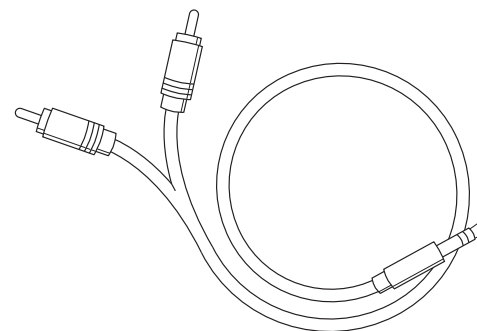

Cable de 3.5 mm a dos RCA

## CONEXIÓN ÓPTICA DIGITAL (PREFERIDA. SI EL TELEVISOR NO TIENE SALIDA ÓPTICA, VEA LA PÁGINA SIGUIENTE)

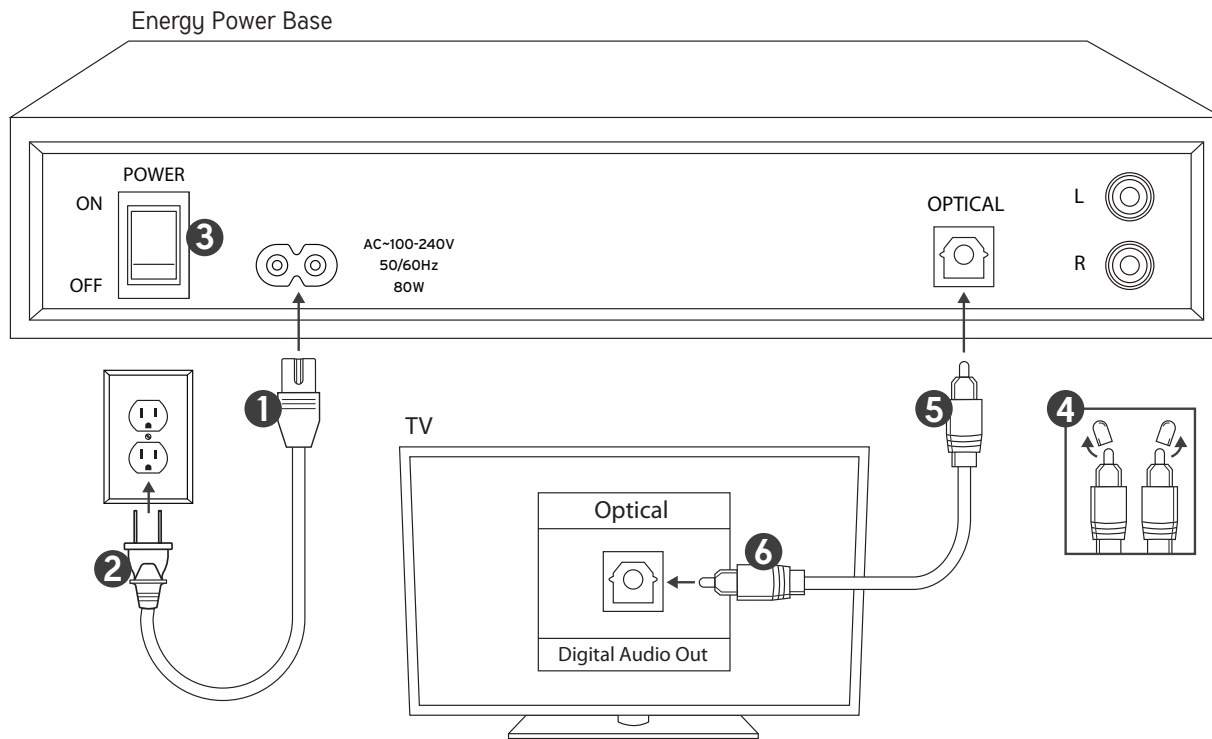

## CONEXIÓN ANALÓGICA RCA DE 3.5 MM A DOS RCA

(SI EL TELEVISOR NO TIENE SALIDA DE AURICULARES, VEA LA PÁGINA SIGUIENTE)

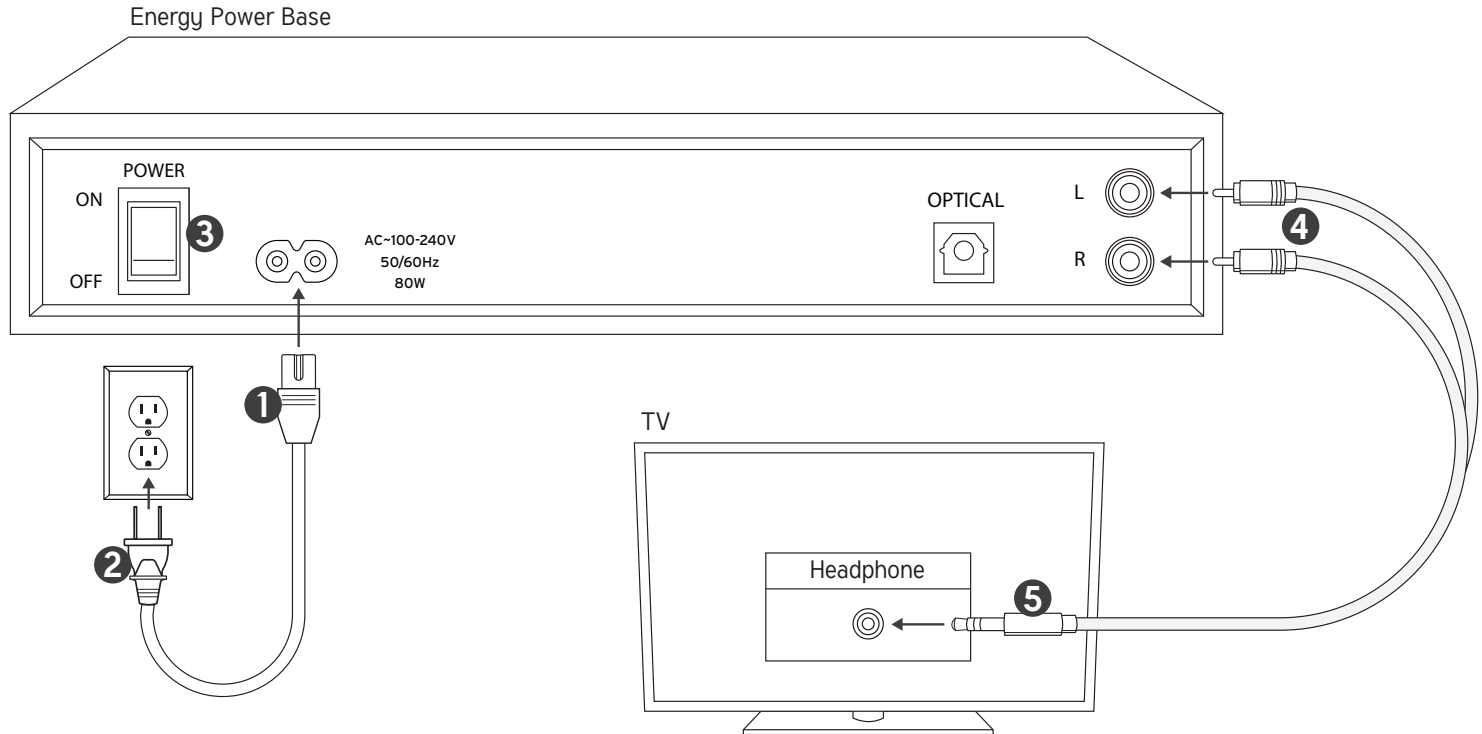

# CONEXIÓN ANALÓGICA DE DOS RCA A DOS RCA

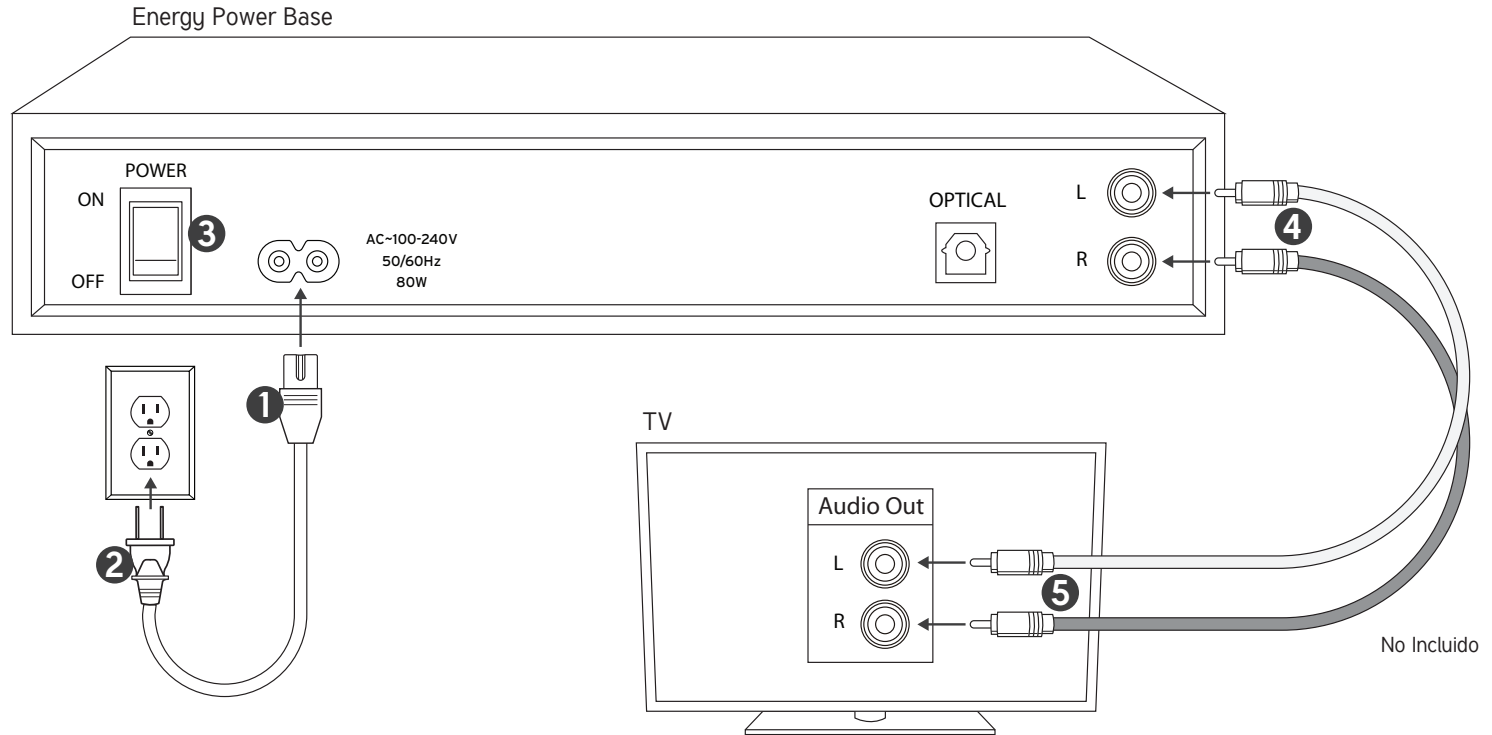

## PROGRAMACIÓN DEL CONTROL REMOTO DEL TELEVISOR

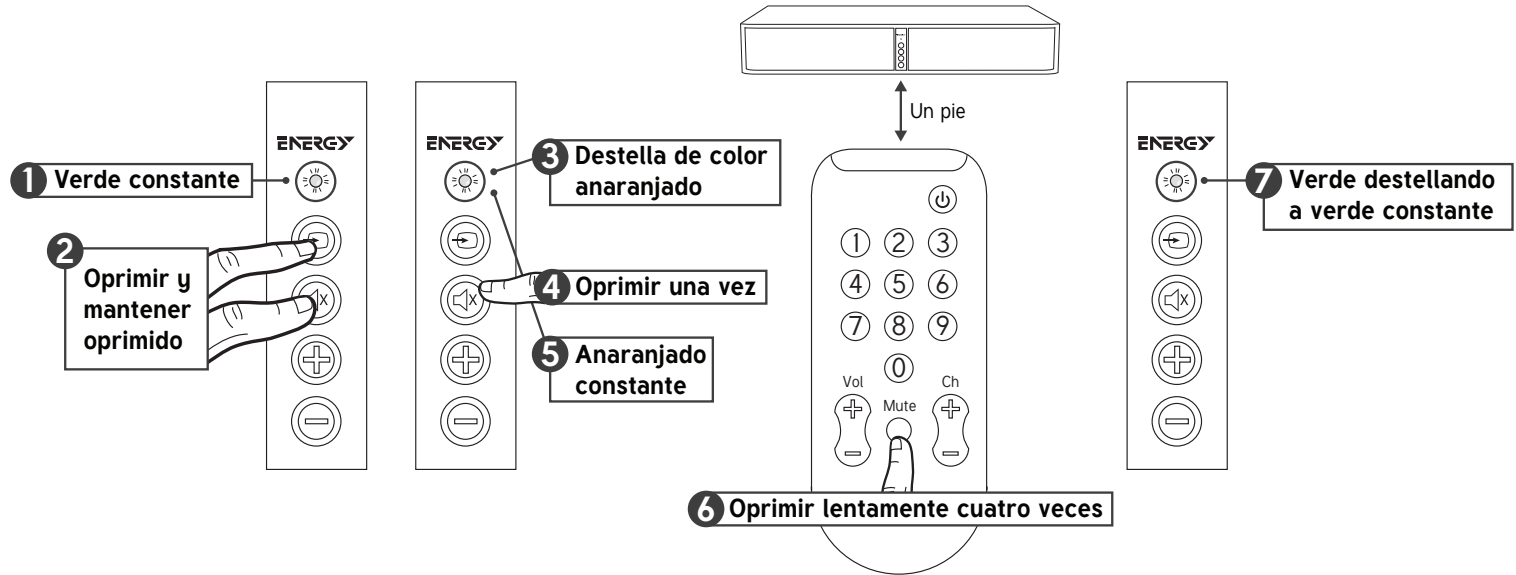

Para programar los botones de subida y bajada de volumen, repita los procedimientos que se indican cambiando los pasos 4 y 6 de manera que correspondan al botón que desea programar.

Si está intentando programar un control remoto de caja de televisión por cable o satélite u otro control remoto universal y no lo logra, intente programar el control remoto de su televisor o caja de televisión por cable.

## TECNOLOGÍA INALÁMBRICA *BLUETOOTH*<sup>®</sup>

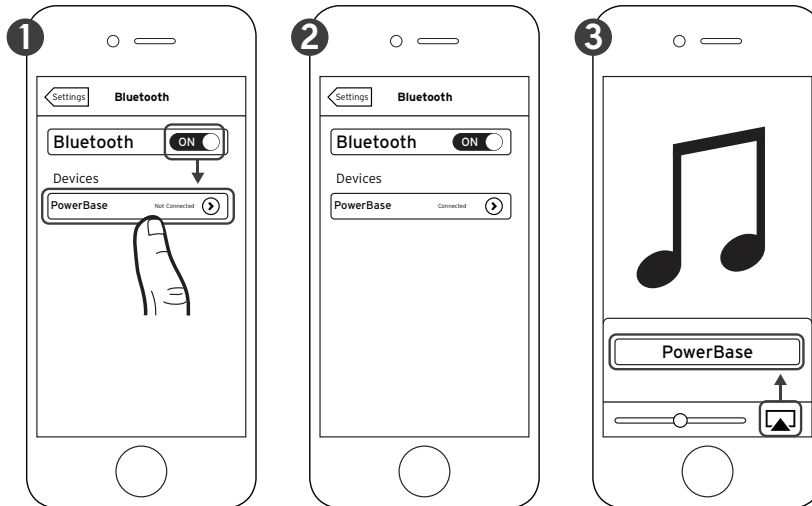

\*Este es solo un ejemplo. Es posible que su dispositivo sea diferente..

Se puede sincronizar un dispositivo *Bluetooth* en cualquier momento activándole la función *Bluetooth*.

Una vez que el dispositivo *Bluetooth* se sincroniza, la Energy Power Base pasa automáticamente a la entrada de *Bluetooth* (LUZ AZUL CONSTANTE) y se puede hacer fluir música. Si cambia de entrada en la Energy Power Base, la conexión *Bluetooth* se termina automáticamente.

Se debe desconectar un dispositivo *Bluetooth* antes de sincronizar otro, lo cual se puede hacer de una de las siguientes maneras:

- Oprimir y mantener oprimido durante tres segundos el botón de fuente (SOURCE) del panel de control de la Energy Power Base
- Desactivar la función *Bluetooth* del dispositivo sincronizado
- Oprimir el botón *Bluetooth* del control remoto de la Energy Power Base

## BOTONES

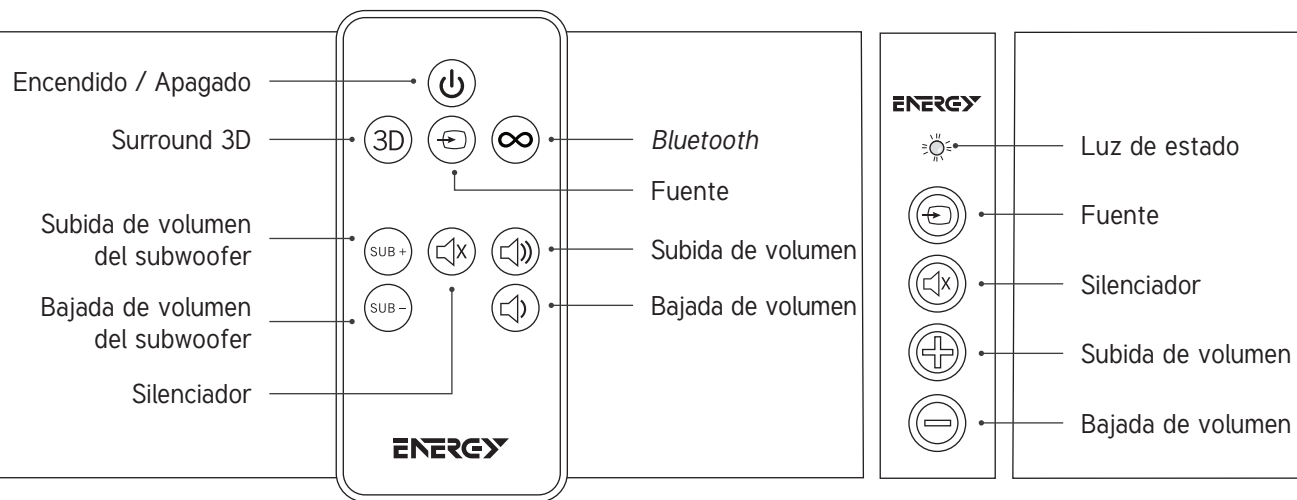



## LUCES DE ESTADO

---

**ROJO CONSTANTE** Apagado (modalidad de espera)

**VERDE CONSTANTE** Encendido, la fuente es la entrada óptica

**ANARANJADO CONSTANTE** Encendido, la fuente es la entrada analógica

**AZUL CONSTANTE** Encendido, la fuente es el dispositivo *Bluetooth* sincronizado

**DESTELLO VERDE / ANARANJADO / AZUL** Se ha oprimido el botón de subida de volumen o el botón de bajada de volumen de la Energy Power Base o el botón de subida o bajada de volumen del subwoofer

**DESTELLO VERDE UNA VEZ** Surround 3D activado

**DESTELLO ROJO UNA VEZ** Surround 3D desactivado

**DESTELLO AZUL RÁPIDO** En espera de sincronización con dispositivo *Bluetooth*

**DESTELLO MORADO LENTO** La Energy Power Base está decodificando Dolby Digital

## MODALIDAD DE ESPERA

---

No es necesario apagar la Energy Power Base, simplemente apague el televisor (o la caja de televisión por cable o satélite) y la Energy Power Base pasará automáticamente a la modalidad de espera en aproximadamente 10 minutos.

La modalidad de espera se indica con una luz de estado roja en el panel delantero. Cuando el televisor (o la caja de televisión por cable o satélite) se vuelve a encender, la Energy Power Base se enciende automáticamente.

## COLOCACIÓN

**El televisor debe pesar menos  
de 36 kg (40 lbs.)**

**La base del televisor debe medir menos  
de 58 cm x 30 cm (23 plg. x 12 plg.)**

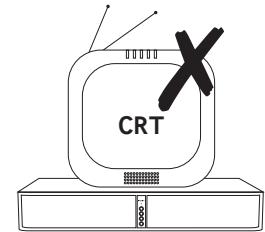
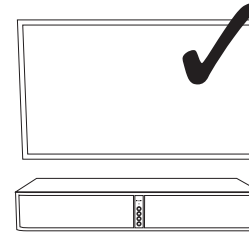
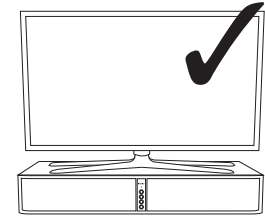
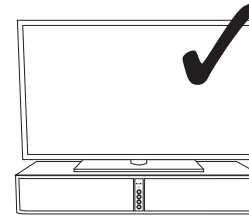
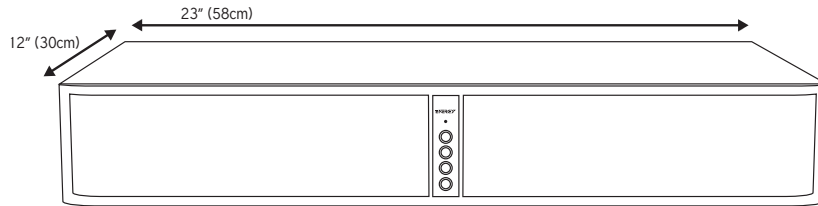

**Para la ventilación, asegúrese de que la parte de atrás de la Energy Power Base se encuentra por lo menos a 1 plg. de la pared y que hay por lo menos 1 plg. de separación por arriba y por los lados de la Energy Power Base.**

## APAGADO DE LOS ALTAVOCES DEL TELEVISOR

---



(Recomendado)

0

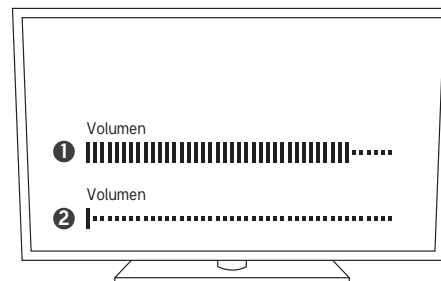

## CUIDADO Y LIMPIEZA

---

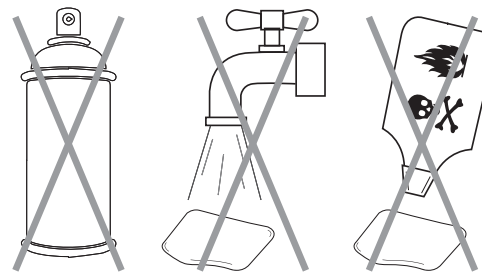
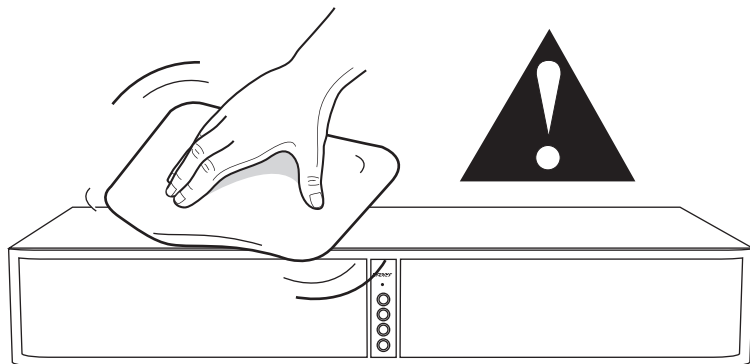

# DETECCIÓN Y REPARACIÓN DE AVERÍAS

---

## La Energy Power Base no se enciende

- ¿Está enchufada en un tomacorriente con corriente?
- ¿Está el interruptor de alimentación de atrás en la posición de encendido?

## No hay sonido

- ¿Está la Energy Power Base enchufada en un tomacorriente con corriente y está el interruptor de alimentación de atrás en la posición de encendido?
- ¿Están todos los cables del televisor o de la caja de televisión por cable o satélite enchufados firmemente?
- Si se está usando el cable óptico, ¿se le retiraron las tapas de plástico transparente de los dos extremos antes de conectarlo?
- ¿Se ha subido el volumen?
- ¿Está la luz de modalidad de espera apagada (la luz de estado no es de color ROJO CONSTANTE)?
- ¿Es correcta la entrada de fuente?
- Pase el interruptor de alimentación de atrás a la posición de apagado y luego a la posición de encendido.

## El control remoto del televisor o de la caja de televisión por cable o satélite no se programa

- Siga cuidadosamente todas las instrucciones de programación del control remoto.
- Vuelva a seguir cuidadosamente todas las instrucciones de programación del control remoto, pero con el control remoto original

que viene con su televisor. NO es necesario volver a programar el control remoto universal o de televisión por cable o satélite.

- Programe el control remoto original del televisor para que funcione con la Energy Power Base (si el original es diferente), y luego use el control remoto universal sin programarlo.
- Es posible que en algunos casos tenga que repetir la programación de alguna función.
- Puede haber casos en que la Energy Power Base no es capaz de aprender ciertos códigos de control remoto.

## El flujo de *Bluetooth* no funciona

- ¿Está el dispositivo *Bluetooth* sincronizado con la Energy Power Base?
- Acerque el dispositivo *Bluetooth* a la Energy Power Base y asegúrese de que estén sincronizados.
- Si la luz de estado destella de color ROJO mientras está intentando sincronizar, vuelva a iniciar el proceso de sincronización.

*Si tiene preguntas, comuníquese con el Departamento de servicio al cliente:  
En Estados Unidos: 1-866-441-8208*



*Fabricado bajo licencia de Dolby Laboratories. Dolby y el símbolo de la doble D son marcas comerciales registradas de Dolby Laboratories.*

*La marca y los logotipos de la palabra Bluetooth® son marcas comerciales registradas propiedad de Bluetooth SIG, Inc. y cualquier uso de tales marcas por parte de Klipsch Group es bajo licencia.*



# PACKUNGSGEHALT

---

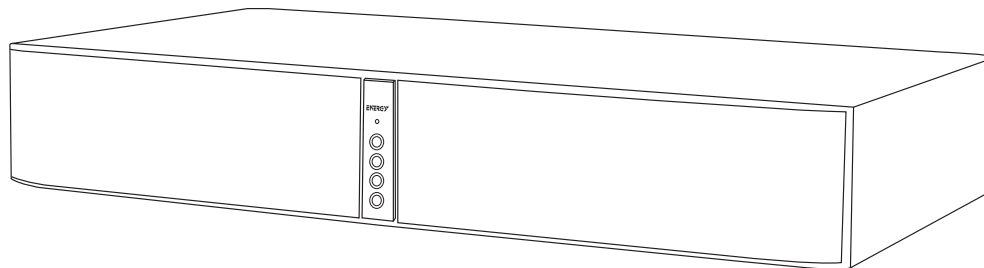

Energy Power® Base

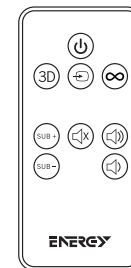

Fernbedienung

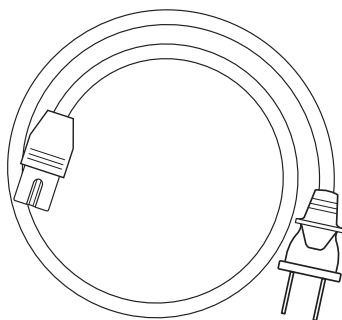

Netzkabel

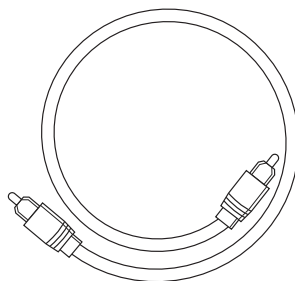

Optisches Digitalkabel

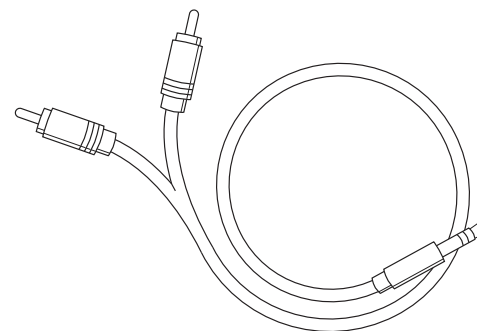

3,5 mm zu Doppel-Cinch-Kabel

# OPTISCHE DIGITALVERBINDUNG

(EMPFOHLEN - FALLS FERNSEHER KEINEN OPTISCHEN AUSGANG HAT, SIEHE NÄCHSTE SEITE)

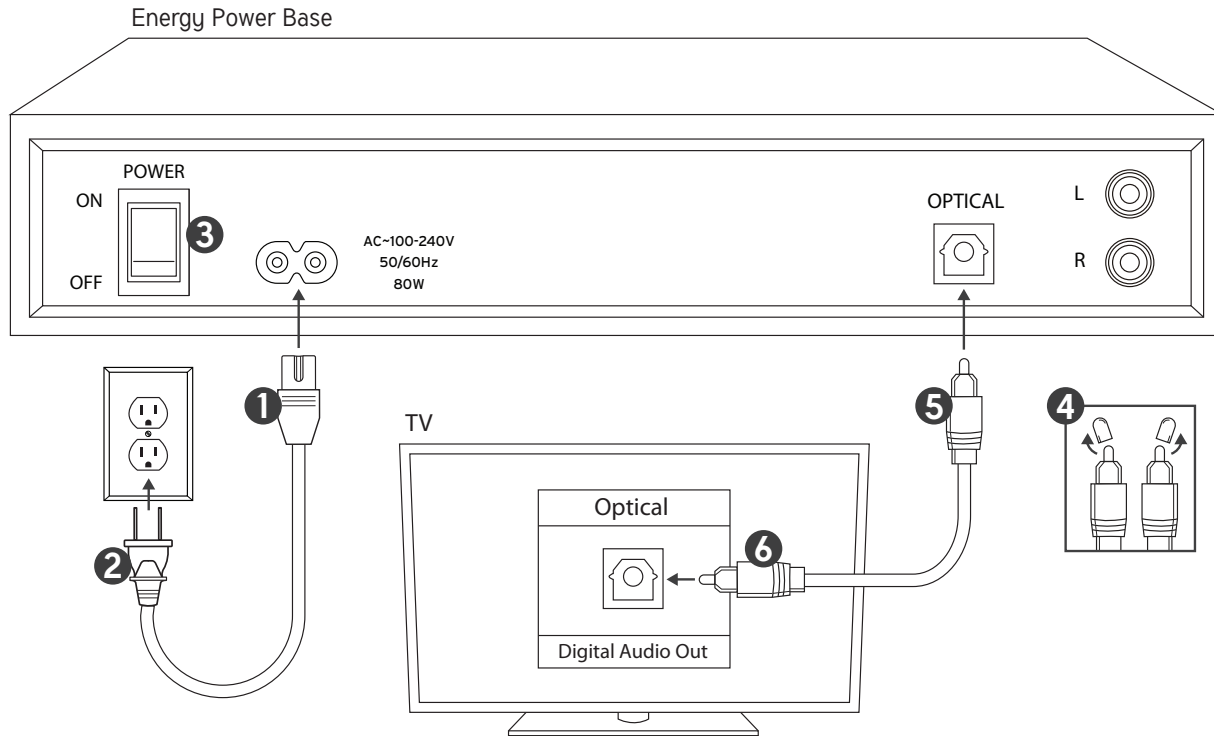

## 3,5 MM ZU DOPPEL-CINCH-ANALOGKABEL

(WENN FERNSEHER KEINEN KOPFHÖRERAUSGANG HAT, SIEHE NÄCHSTE SEITE)

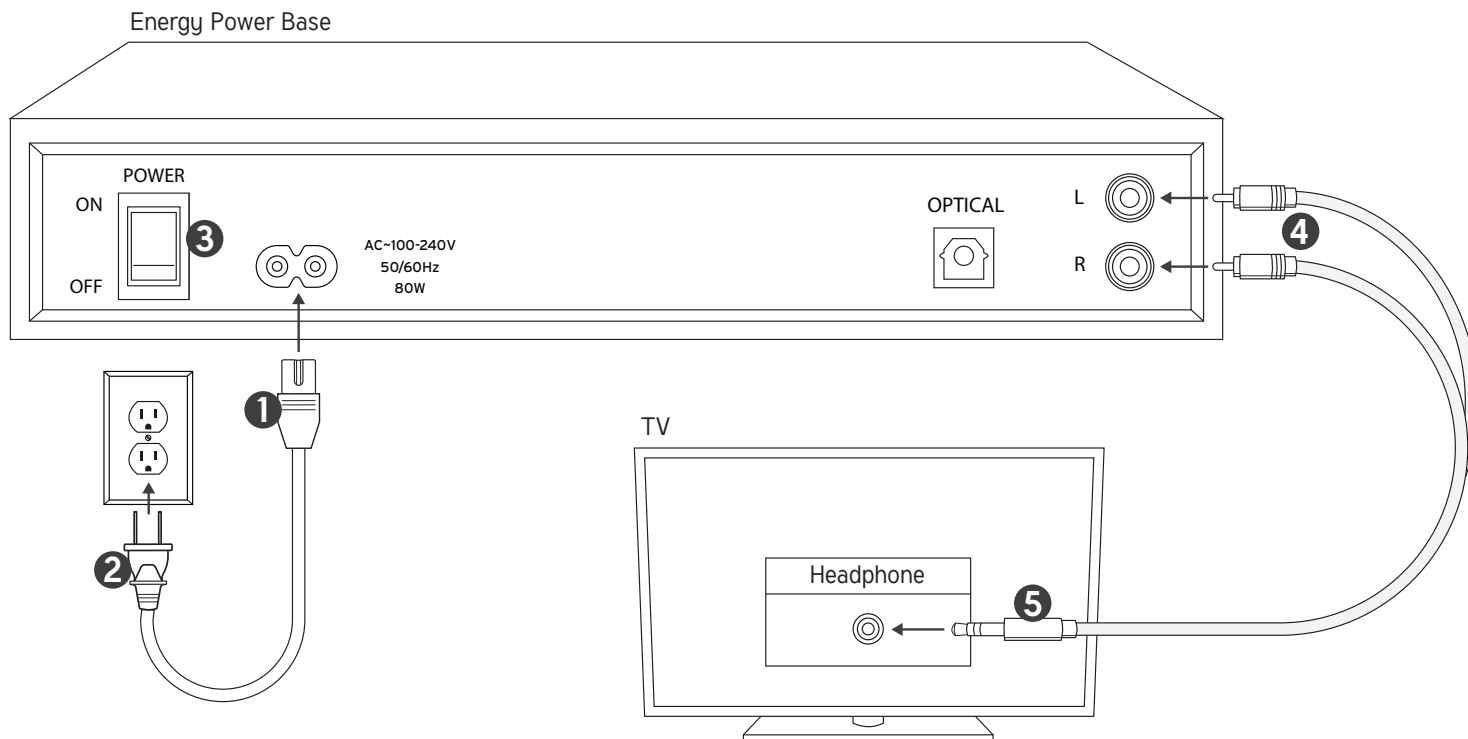



## ANALOGVERBINDUNG (DOPPEL-CINCH ZU DOPPEL-CINCH)

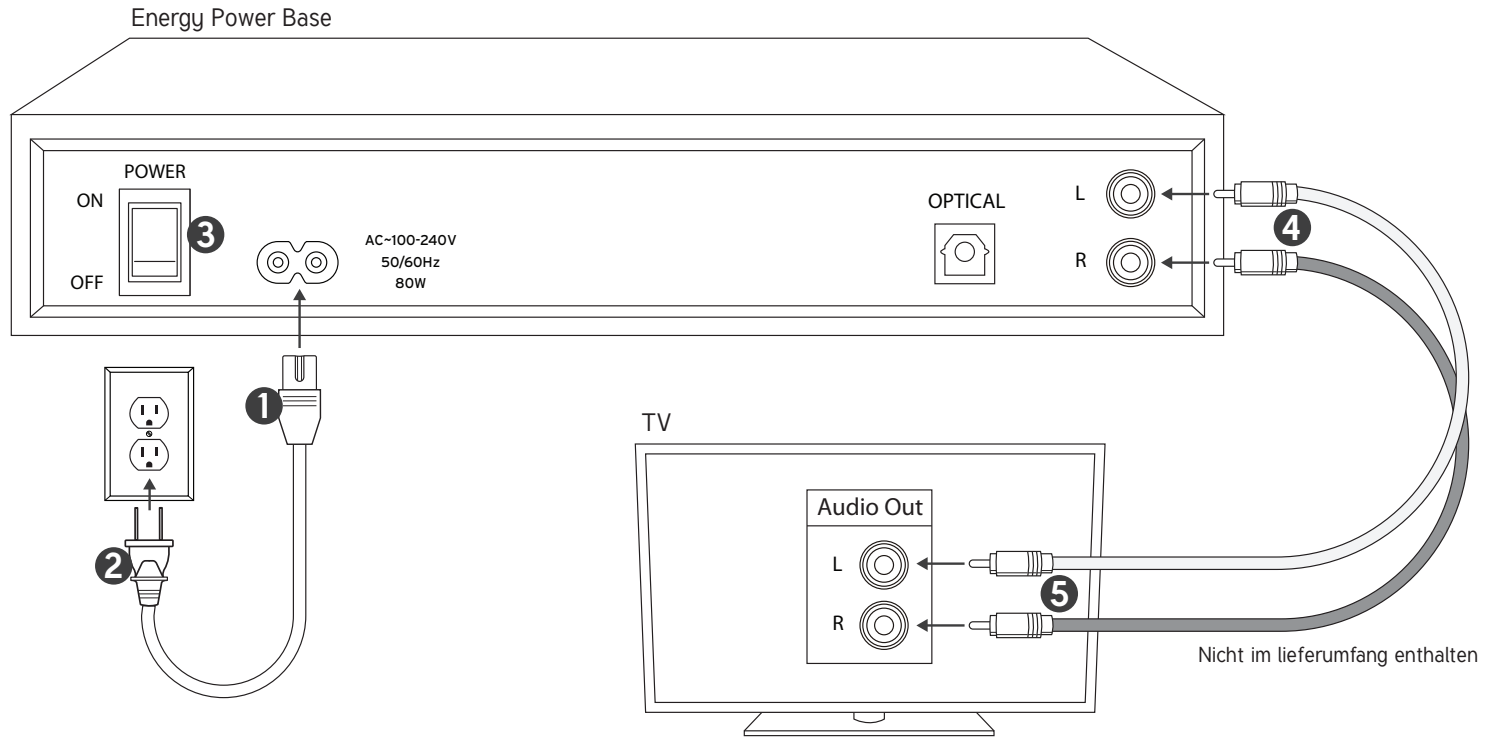

## PROGRAMMIEREN DER TV-FERNBEDIENUNG

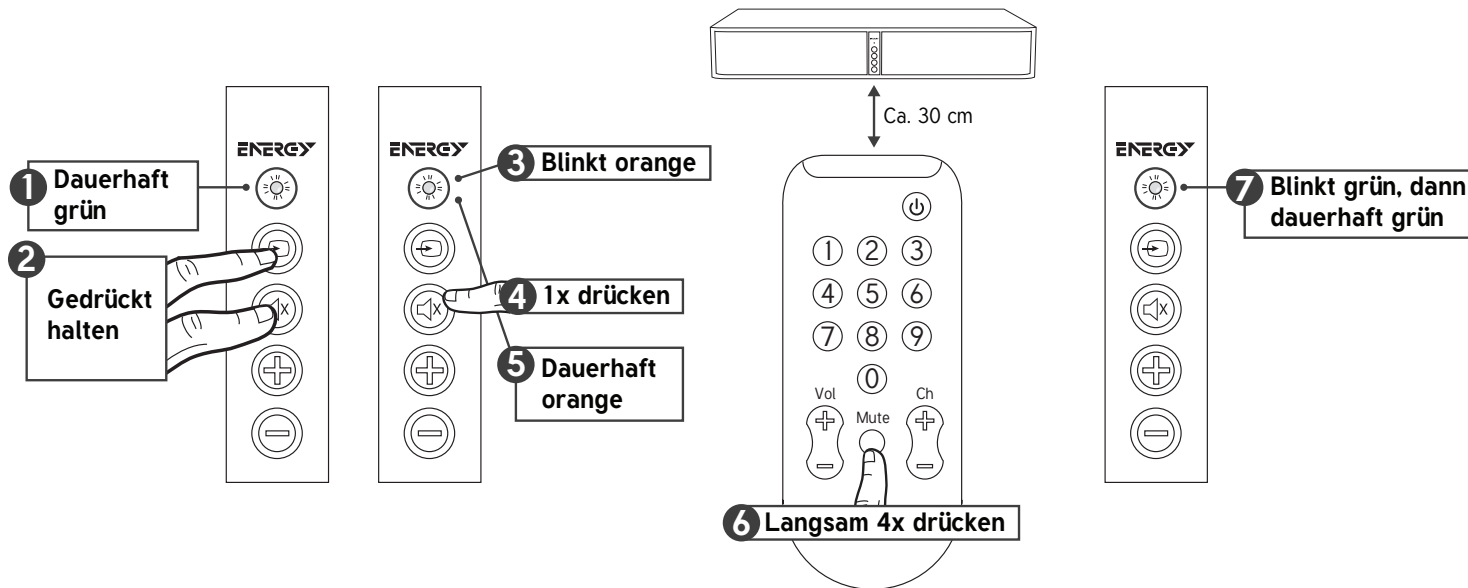

Um die Lauter- und Leiser-Tasten zu programmieren, wiederholen Sie die aufgeführten Schritte und wählen in Schritt 4 und 6 die zu programmierenden Taste.

Wenn Sie Probleme haben, eine Kabel-/Satelliten-Box oder eine Universal-Fernbedienung zu programmieren, sollten Sie versuchen, statt dessen die Fernbedienung des Fernsehers oder der Kabel-Box zu programmieren.

## BLUETOOTH® DRAHTLOS-TECHNOLOGIE

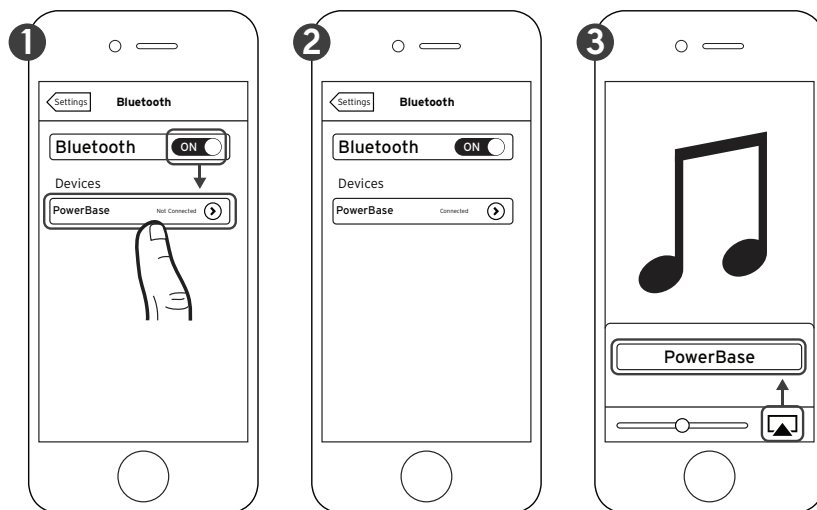

\*Nur als Beispiel. Ihr Gerät kann anders aussehen

Sie können jederzeit eine Verbindung (Pairing) zu einem *Bluetooth*-Gerät herstellen, indem Sie *Bluetooth* auf Ihrem Gerät aktivieren.

Nachdem das Pairing mit Ihrem *Bluetooth*-Gerät abgeschlossen ist, wechselt die Energy Power Base automatisch zum *Bluetooth*-Eingang (STÄNDIG BLAUES LICHT) und Sie können Musik streamen. Wenn Sie den Eingang an der Energy Power Base wechseln, wird die *Bluetooth*-Verbindung automatisch beendet.

Bevor Sie das Pairing mit einem neuen *Bluetooth*-Gerät durchführen, müssen Sie das alte Pairing auf einer dieser Weisen deaktivieren:

- Halten Sie die Taste SOURCE am Bedienfeld der Energy Power Base 3 Sekunden lang gedrückt
- Schalten Sie am verbundenen Gerät die *Bluetooth*-Funktion aus
- Drücken Sie die *Bluetooth*-Taste an der Fernbedienung der Energy Power Base

# TASTEN

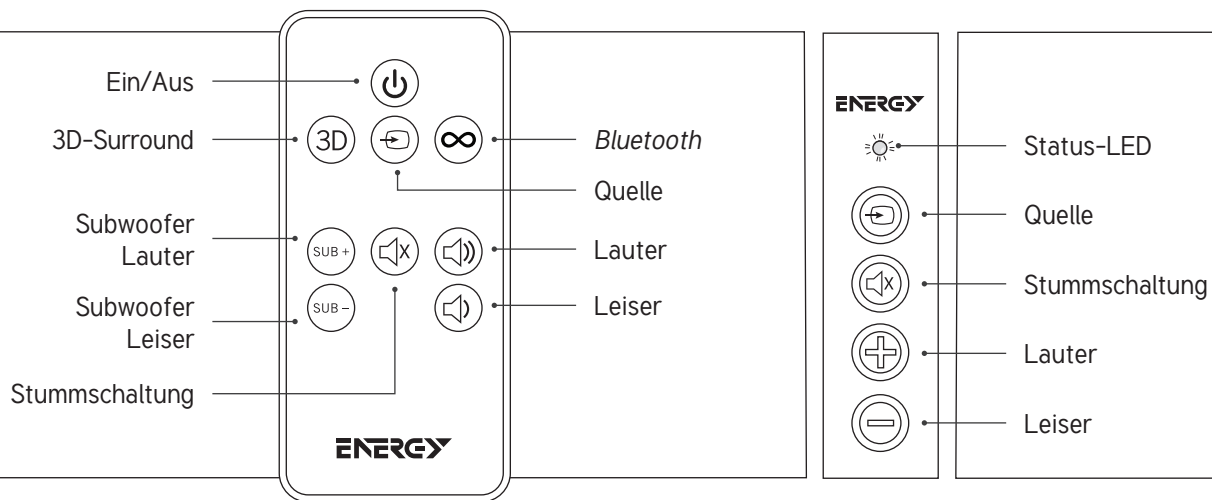

## STATUSLEUCHTEN

---

**DAUERHAFT ROT** Ausgeschaltet (Standby-Modus)

**BLINKT 1x GRÜN** 3D-Surround aktiviert

**DAUERHAFT GRÜN** Eingeschaltet, Quelle ist der optische Eingang

**BLINKT 1x ROT** 3D-Surround deaktiviert

**DAUERHAFT ORANGE** Eingeschaltet, Quelle ist der Analog-Eingang

**BLINKT SCHNELL BLAU** Wartet auf Pairing mit *Bluetooth*-Gerät

**DAUERHAFT BLAU** Eingeschaltet, Quelle ist das verbundene *Bluetooth*-Gerät

**BLINKT LANGSAM LILA** Energy Power Base decodiert Dolby Digital

**BLINKT GRÜN / ORANGE / BLAU** Lauter, Leiser, Subwoofer lauter oder Subwoofer leiser gedrückt

## STANDBY-MODUS

---

Sie müssen die Energy Power Base nicht abschalten. Schalten Sie einfach Ihren Fernseher (oder die Satelliten-/Kabel-Box) aus, und die Power Base geht innerhalb von 10 Minuten automatisch in den Standby-Modus über.

Der Standby-Modus wird durch eine rote Status-LED an der Vorderseite angezeigt. Wenn Ihr Fernseher (oder die Satelliten-/Kabel-Box) wieder eingeschaltet wird, schaltet sich auch die Energy Power Base automatisch wieder ein.

## PLATZIERUNG

Der Fernseher darf maximal  
36 kg wiegen

Der Sockel des Fernseher muss  
kleiner als 58 cm x 30 cm sein

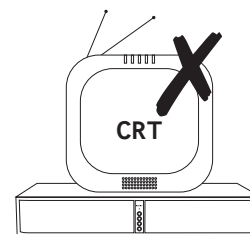
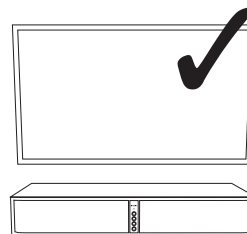
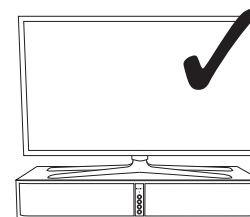
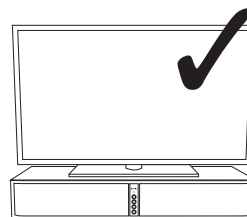
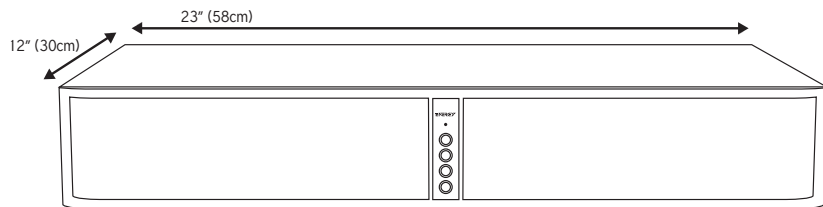

Stellen Sie sicher, dass die Rückseite der Energy Power Base mindestens 2,5 cm von der Rückwand entfernt ist und dass es über und an der Seite der Energy Power Base mindestens 2,5 cm Freiraum gibt, um eine gute Lüftung zu ermöglichen.

## TV-LAUTSPRECHER DEAKTIVIEREN

---



(Empfohlen)

ODER

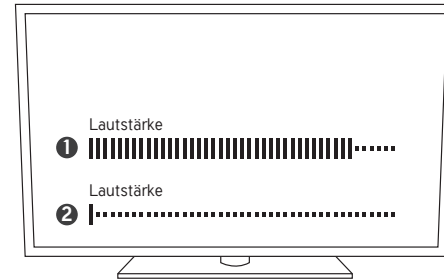

## PFLEGE UND REINIGUNG

---

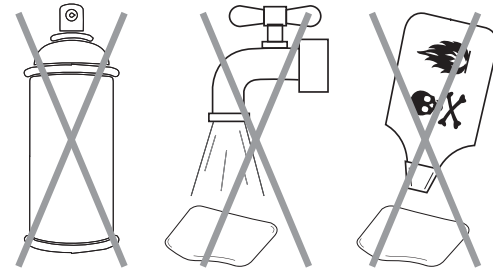
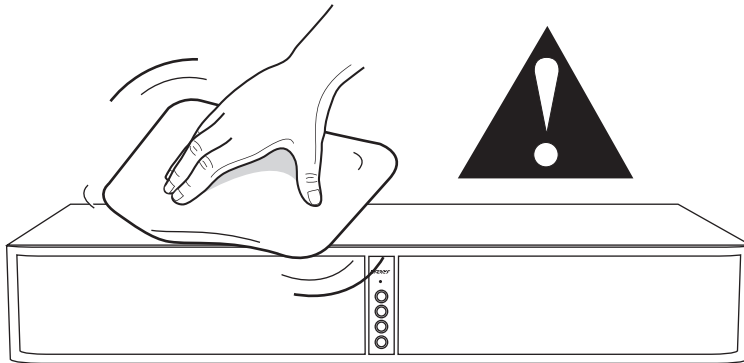

## PROBLEMBESEITIGUNG

---

### Die Energy Power Base schaltet sich nicht ein

- Ist sie an eine Strom führende Steckdose angeschlossen?
- Ist der Netzschalter an der Rückseite eingeschaltet?

### Kein Sound

- Ist sie an eine stromführende Steckdose angeschlossen, und ist der Netzschalter an der Rückseite eingeschaltet?
- Sind alle Verbindungen vom Fernseher bzw. der Kabel- oder Satelliten-Box fest eingesteckt?
- Wenn das optische Kabel verwendet wird, wurden vor dem Anschluss die durchsichtigen Plastikabdeckungen von beiden Enden abgenommen?
- Ist die Lautstärke hoch genug eingestellt?
- Ist der Standby-Modus deaktiviert (keine DAUERHAFT ROTE Status-LED)?
- Ist die korrekte Eingangsquelle gewählt?
- Schalten Sie den Netzschalter an der Rückseite aus und dann wieder ein.

### Fernbedienung für TV/Kabel-Box/Satelliten-Box lässt sich nicht programmieren

- Folgen Sie allen Programmieranweisungen für die Fernbedienung genau.
- Wiederholen Sie sorgfältig die Programmierung der Fernbedienung, aber verwenden Sie die Original-Fernbedienung des Fernsehers. Sie müssen dann NICHT Ihre Fernbedienung für die Kabel-/Satelliten-Box oder die Universal-Fernbedienung umprogrammieren.
- Programmieren Sie die Original-Fernbedienung des Fernsehers auf die Energy Power Base (falls die Original-Fernbedienung eine andere

ist) und verwenden Sie dann die Universal-Fernbedienung, ohne sie zu programmieren.

- In manchen Fällen müssen Sie eventuell die Programmierung einer Funktion wiederholen.
- Es kann der Fall sein, dass die Energy Power Base nicht in der Lage ist, die Codes bestimmter Fernbedienungen zu erlernen.

### Das Bluetooth-Streaming funktioniert nicht

- Ist das *Bluetooth*-Gerät mit der Energy Power Base verbunden?
- Bringen Sie Ihr *Bluetooth*-Gerät näher an die Energy Power Base und stellen Sie sicher, dass ein Pairing existiert.
- Wenn beim Pairing die Status-LED ROT aufblinkt, sollten Sie das Pairing-Verfahren erneut beginnen.

*Sollten Sie Fragen haben, wenden Sie sich bitte an den Kundendienst von Energy:  
In den Vereinigten Staaten: 1-866-441-8208*



*Unter Lizenz von Dolby Laboratories hergestellt. Dolby und das Doppel-D-Symbol sind eingetragene Marken von Dolby Laboratories.*

*Die Bluetooth® Wortmarke und die Logos sind eingetragene Marken der Bluetooth SIG, Inc., und jegliche Nutzung dieser Marken durch Klipsch Group, Inc. erfolgt unter Lizenz.*





## CONTENUTO DELLA CONFEZIONE

---

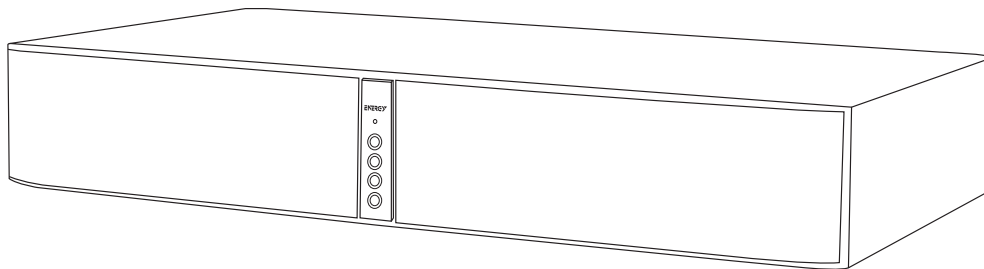

Energy Power® Base

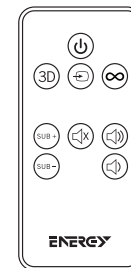

Telecomando

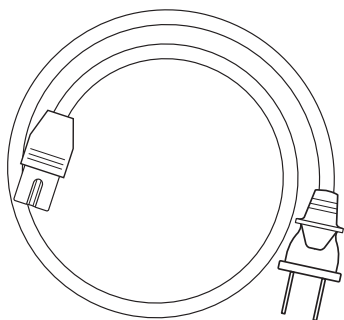

Cavo di alimentazione

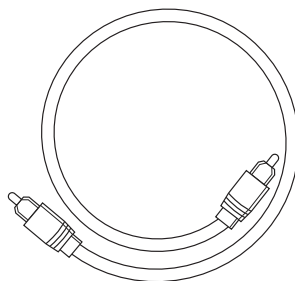

Cavo ottico digitale

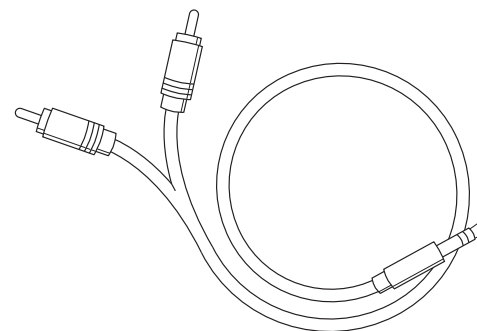

Cavo con jack da 3,5 mm a doppio jack RCA

## CONNESSIONE OTTICA DIGITALE

(PREFERIBILE - SE IL TELEVISORE NON HA UN'USCITA OTTICA, VEDERE ALLA PAGINA SUCCESSIVA)

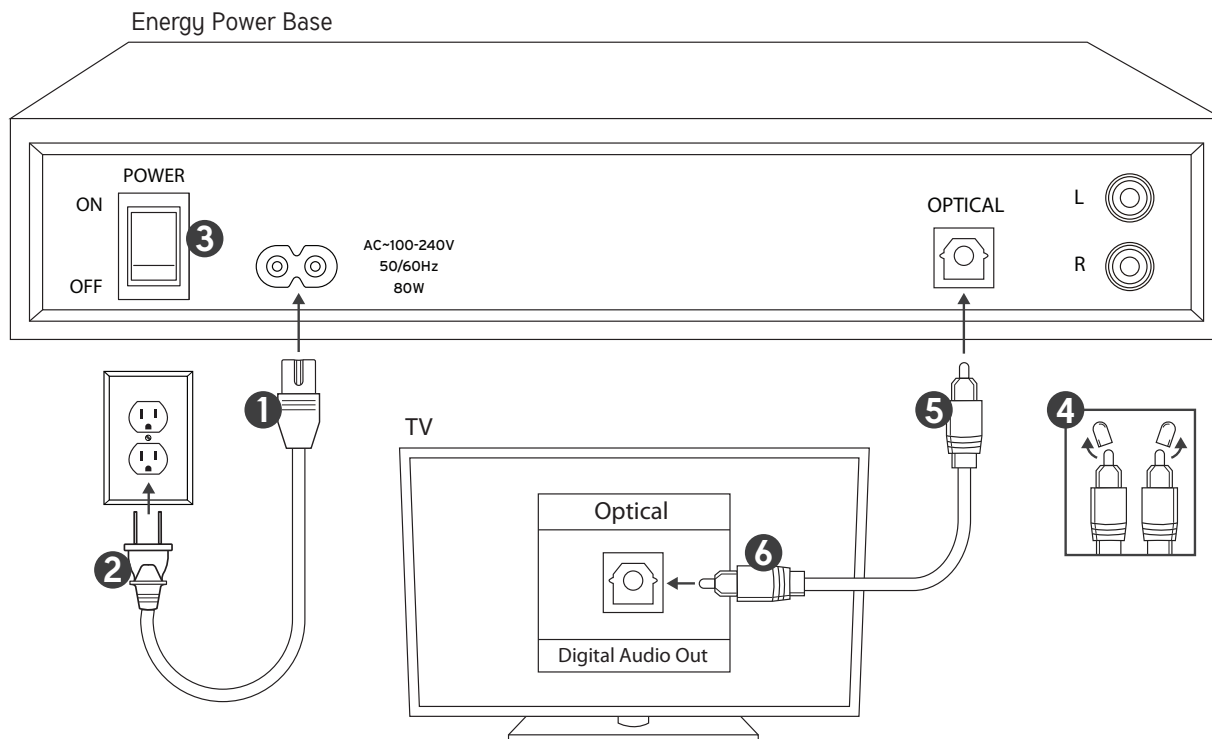

# Energy Power Base

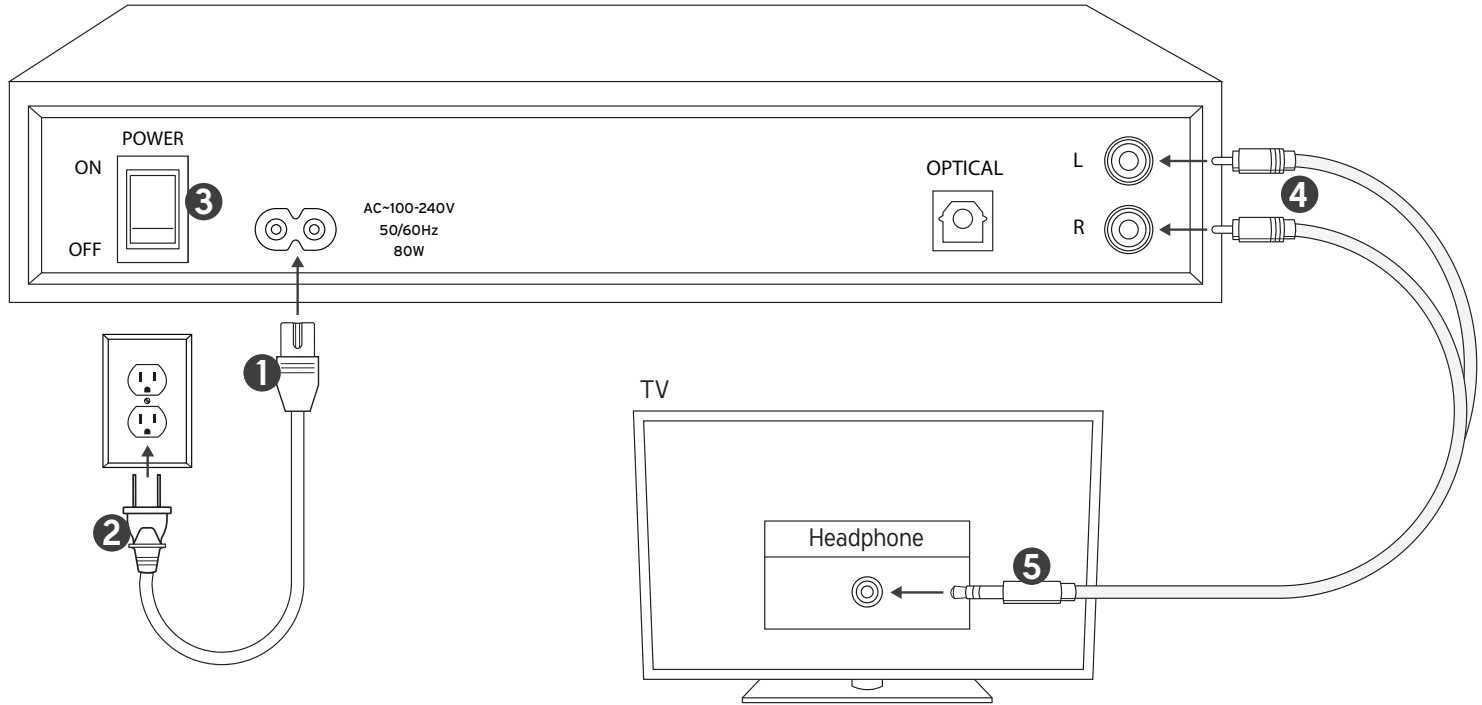

## CONNESSIONE ANALOGICA DA DOPPIO JACK RCA A DOPPIO JACK RCA

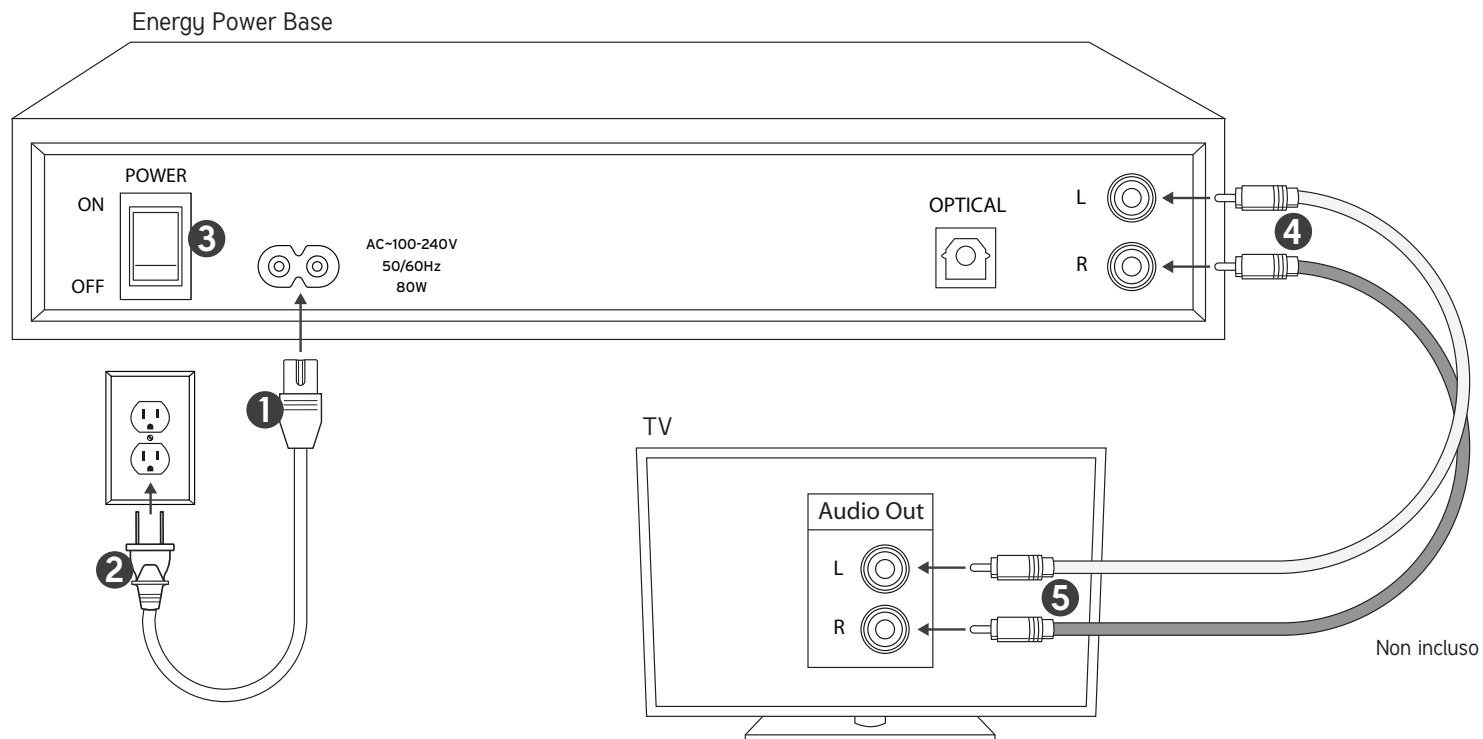

## PROGRAMMAZIONE CON IL TELECOMANDO TV

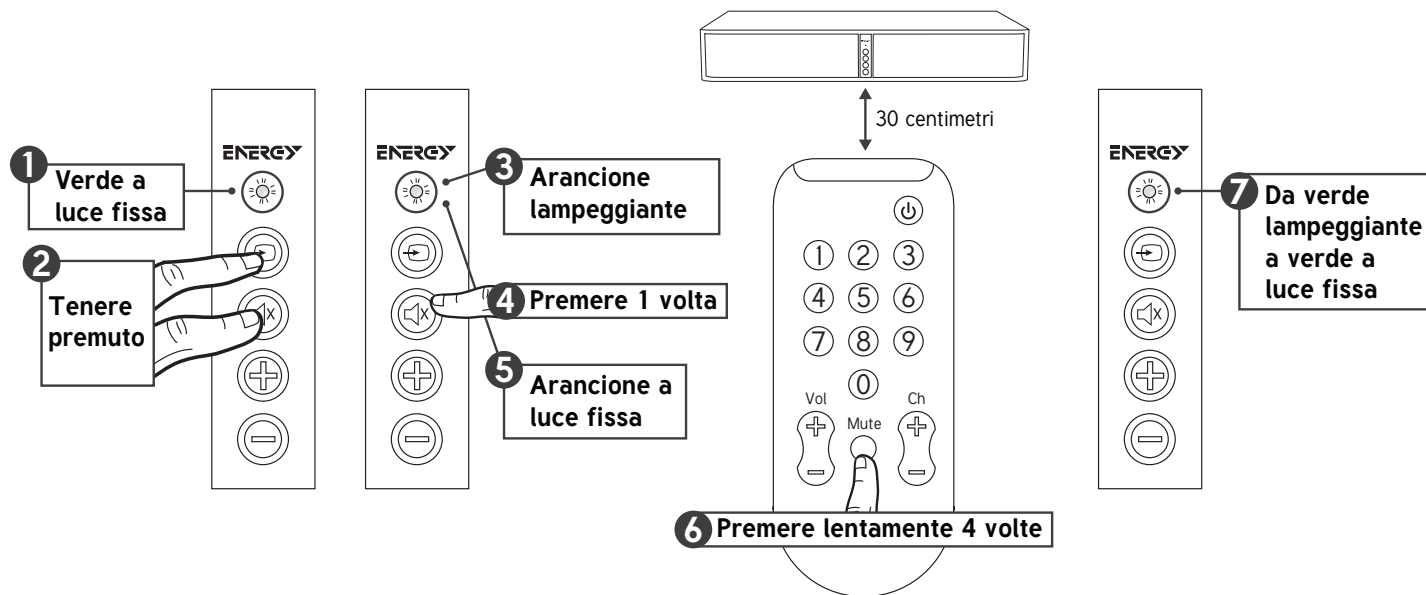

Per programmare i pulsanti di Aumento volume e Riduzione volume, ripetere i passaggi illustrati e sostituire i passaggi 4 e 6 con il pulsante che si desidera programmare.

Se si sta cercando di programmare il telecomando di un decoder via cavo/satellitare o altro telecomando universale ma l'operazione non riesce, cercare di programmare invece il telecomando del decoder via cavo o del televisore.

## TECNOLOGIA WIRELESS *BLUETOOTH*<sup>®</sup>

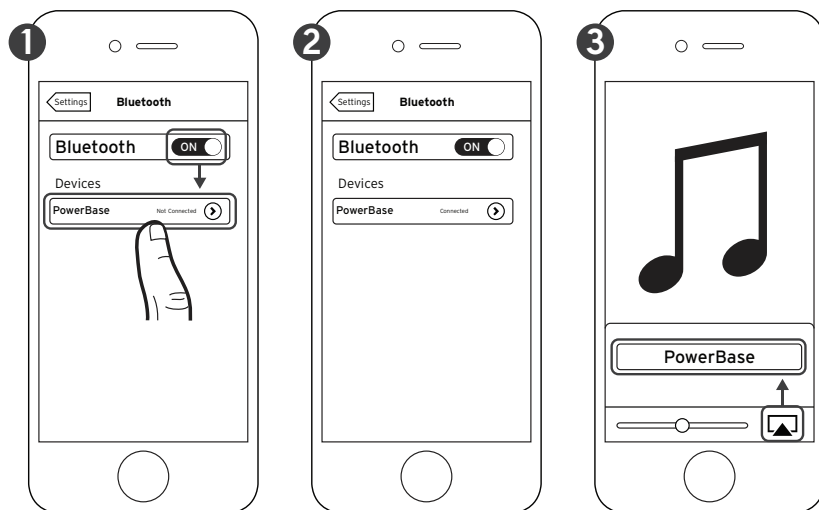

\*Solo a titolo esemplificativo. Lo specifico dispositivo può essere diverso.

È possibile associare un dispositivo *Bluetooth* in qualunque momento attivando *Bluetooth* sul dispositivo stesso.

Dopo che si è associato il dispositivo *Bluetooth*, l'Energy Power Base seleziona automaticamente l'ingresso *Bluetooth* (SPIA BLU ACCESA A LUCE FISSA) e si può trasmettere in streaming la musica. Se si seleziona un altro ingresso sull'Energy Power Base, la connessione *Bluetooth* viene terminata automaticamente.

È necessario scollegare un dispositivo *Bluetooth* prima di associarne un altro, in uno dei seguenti modi:

- Tenendo premuto per 3 secondi il pulsante **SORGENTE** sul pannello di controllo dell'Energy Power Base
- Disattivando *Bluetooth* sul dispositivo associato
- Premendo il pulsante *Bluetooth* sul telecomando dell'Energy Power Base

## PULSANTI

Acceso / Spento



Surround 3D



Bluetooth

Sorgente

Aumento volume  
subwoofer



Aumento volume

Riduzione volume  
subwoofer



Riduzione volume

Disattivazione  
audio

**ENERGY**

**ENERGY**



Spia di stato



Sorgente



Disattivazione audio



Aumento volume



Riduzione volume



## SPIE DI STATO

---

<b>ROSSA A LUCE FISSA</b>	Spento (modalità di standby)	<b>UN LAMPEGGIO IN VERDE</b>	Surround 3D attivato
<b>VERDE A LUCE FISSA</b>	Acceso; la sorgente è l'ingresso ottico	<b>UN LAMPEGGIO IN ROSSO</b>	Surround 3D disattivato
<b>ARANCIONE A LUCE FISSA</b>	Acceso; la sorgente è l'ingresso analogico	<b>BLU LAMPEGGIANTE VELOCEMENTE</b>	In attesa di associazione con un dispositivo <i>Bluetooth</i>
<b>BLU A LUCE FISSA</b>	Acceso; la sorgente è un dispositivo <i>Bluetooth</i> associato	<b>VIOLA LAMPEGGIANTE LENTAMENTE</b>	L'Energy Power Base sta decodificando un segnale digitale Dolby
<b>BLU / ARANCIONE / VERDE LAMPEGGIANTE</b>	È stato premuto il pulsante di aumento o riduzione del volume oppure di aumento o riduzione di volume del subwoofer		

## MODALITÀ DI STANDBY

---

Non è necessario spegnere l'Energy Power Base; è sufficiente spegnere il televisore (o il decoder via cavo / satellitare) e l'Energy Power Base passa automaticamente alla modalità di standby entro circa 10 minuti.

La modalità di standby è indicata da una spia di stato rossa sul pannello anteriore. Quando si riaccende il televisore (o il decoder via cavo / satellitare), l'Energy Power Base si riaccende automaticamente.

## COLLOCAZIONE

**Il televisore deve pesare meno di 36 kg**

**Le dimensioni della base del  
televisore devono essere inferiori  
a 58 cm x 30 cm**

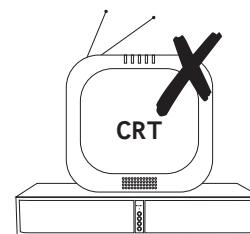
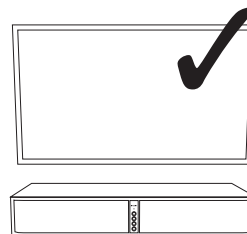
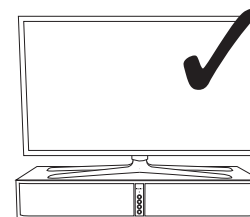
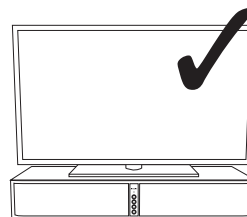
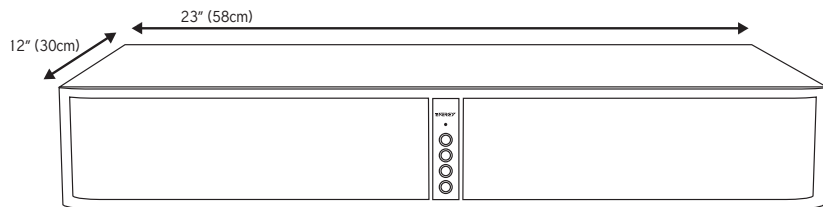

**Accertarsi che la parte posteriore dell'Energy Power Base si trovi a una distanza di almeno 2,5 centimetri dalla parete posteriore e che vi sia una distanza libera di almeno 2,5 centimetri intorno alle parti superiore e laterali dell'Energy Power Base per la ventilazione.**

## SPEGNIMENTO DEGLI ALTOPARLANTI DEL TELEVISORE

---



(Consigliato)

OPPURE

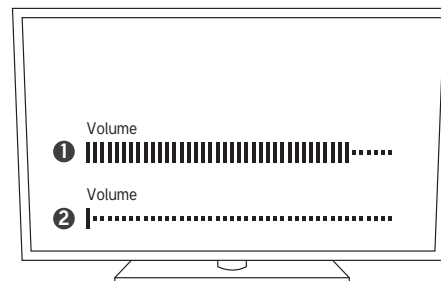

## CURA E PULIZIA

---

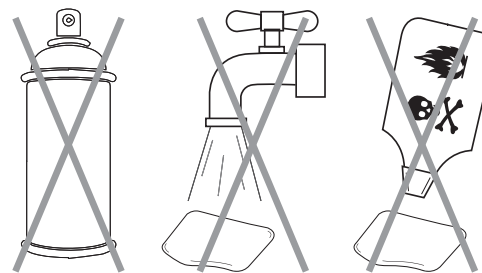
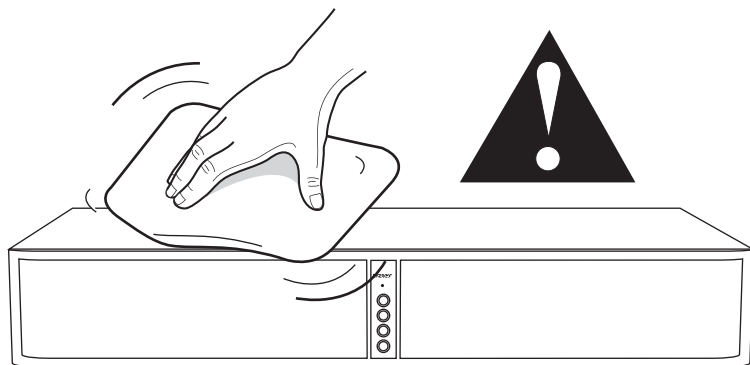

## GUIDA ALLA SOLUZIONE DEI PROBLEMI

---

### L'Energy Power Base non si accende

- È collegato a una presa elettrica sotto tensione?
- L'interruttore di alimentazione, sul pannello posteriore, è nella posizione 'Acceso'?

### Nessun suono

- È collegato a una presa elettrica sotto tensione e l'interruttore di alimentazione, sul pannello posteriore, è nella posizione 'Acceso'?
- Tutti i cavi uscenti dal televisore/decoder via cavo / satellitare sono inseriti bene?
- Se si usa il cavo ottico, prima della connessione sono stati rimossi i tappi di plastica trasparente da entrambe le estremità?
- Il volume è stato aumentato?
- La modalità di standby è disattivata (nessuna spia di stato ROSSA A LUCE FISSA)?
- L'ingresso di sorgente è corretto?
- Portare l'interruttore di alimentazione, sul pannello posteriore, nella posizione 'Spento' e quindi di nuovo su 'Acceso'.

### Il telecomando del televisore/decoder via cavo / satellitare non programma

- Seguire con attenzione tutte le istruzioni per la programmazione del telecomando.
- Seguire di nuovo con attenzione tutte le istruzioni per la programmazione del telecomando, ma usare il telecomando originale fornito

con il televisore. NON è necessario quindi riprogrammare con il telecomando universale o del decoder via cavo/satellitare.

- Programmare il telecomando originale del televisore sull'Energy Power Base (se quello originale è uno diverso), quindi usare il telecomando universale senza programmarlo.
- In alcuni casi può essere necessario ripetere la programmazione di una funzione.
- In alcuni casi, l'Energy Power Base potrebbe non essere in grado di memorizzare determinati codici del telecomando.

### La trasmissione in streaming **Bluetooth** non funziona

- Il dispositivo **Bluetooth** è associato all'Energy Power Base?
- Avvicinare il dispositivo **Bluetooth** all'Energy Power Base e accertarsi che sia associato.
- Se la spia di stato lampeggia in ROSSO mentre si cerca di associare il dispositivo, ricominciare da capo la procedura di associazione.

*Per eventuali domande contattare il servizio clienti Energy:*

*Negli Stati Uniti: 1-866-441-8208*



*Fabbricato su licenza di Dolby Laboratories. Dolby e il simbolo della doppia D sono marchi registrati di Dolby Laboratories.*

*Il logo e la parola Bluetooth® sono marchi registrati di Bluetooth SIG, Inc. e qualunque loro uso da parte di Klipsch Group, Inc. è su licenza.*



## O QUE ESTÁ INCLUÍDO

---

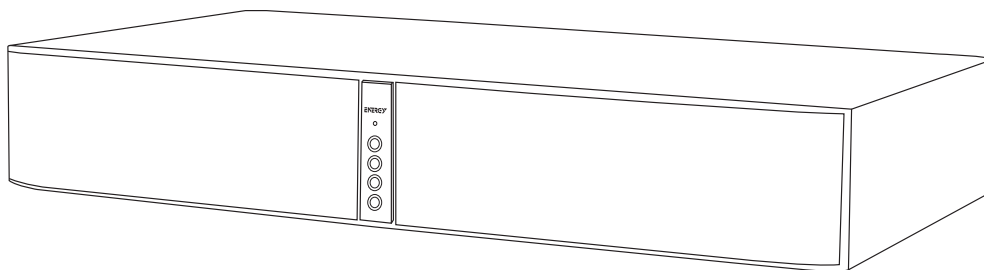

Energy Power® Base

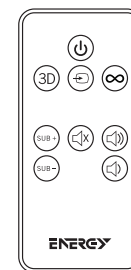

Controle remoto

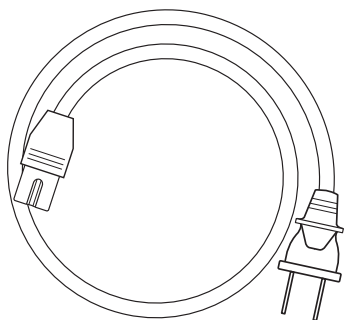

Cabo de alimentação de CA

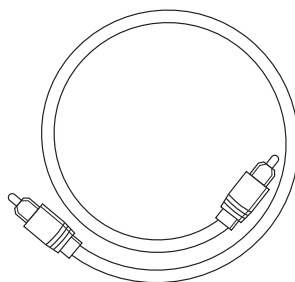

Cabo óptico digital

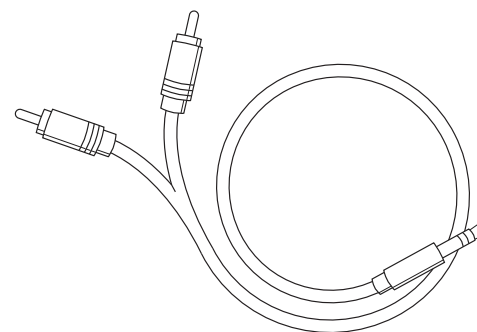

Cabo para conexão de 3,5 mm para RCA duplo

# CONEXÃO ÓTICA DIGITAL

(PREFERENCIAL - SE A TV NÃO TIVER SAÍDA ÓTICA, CONSULTE A PRÓXIMA PÁGINA)

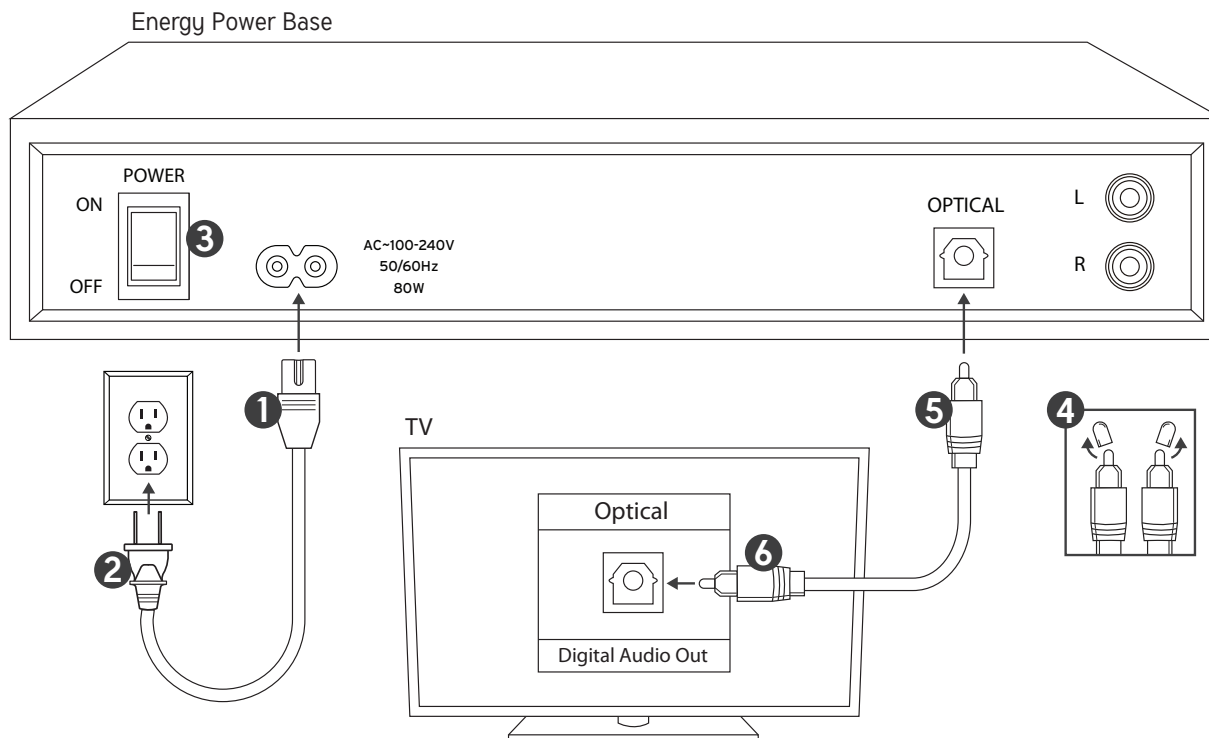

# Energy Power Base

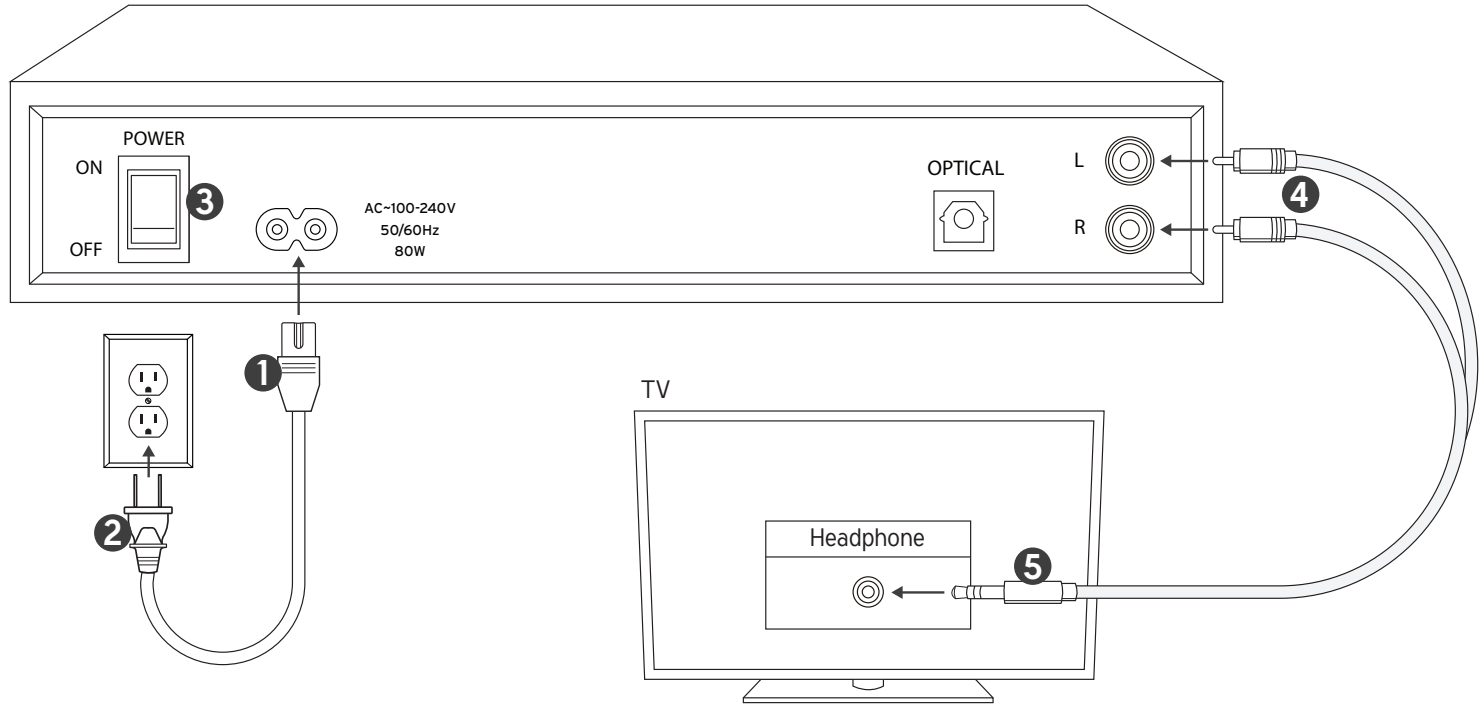



## CONEXÃO ANALÓGICA DE RCA DUPLO PARA RCA DUPLO

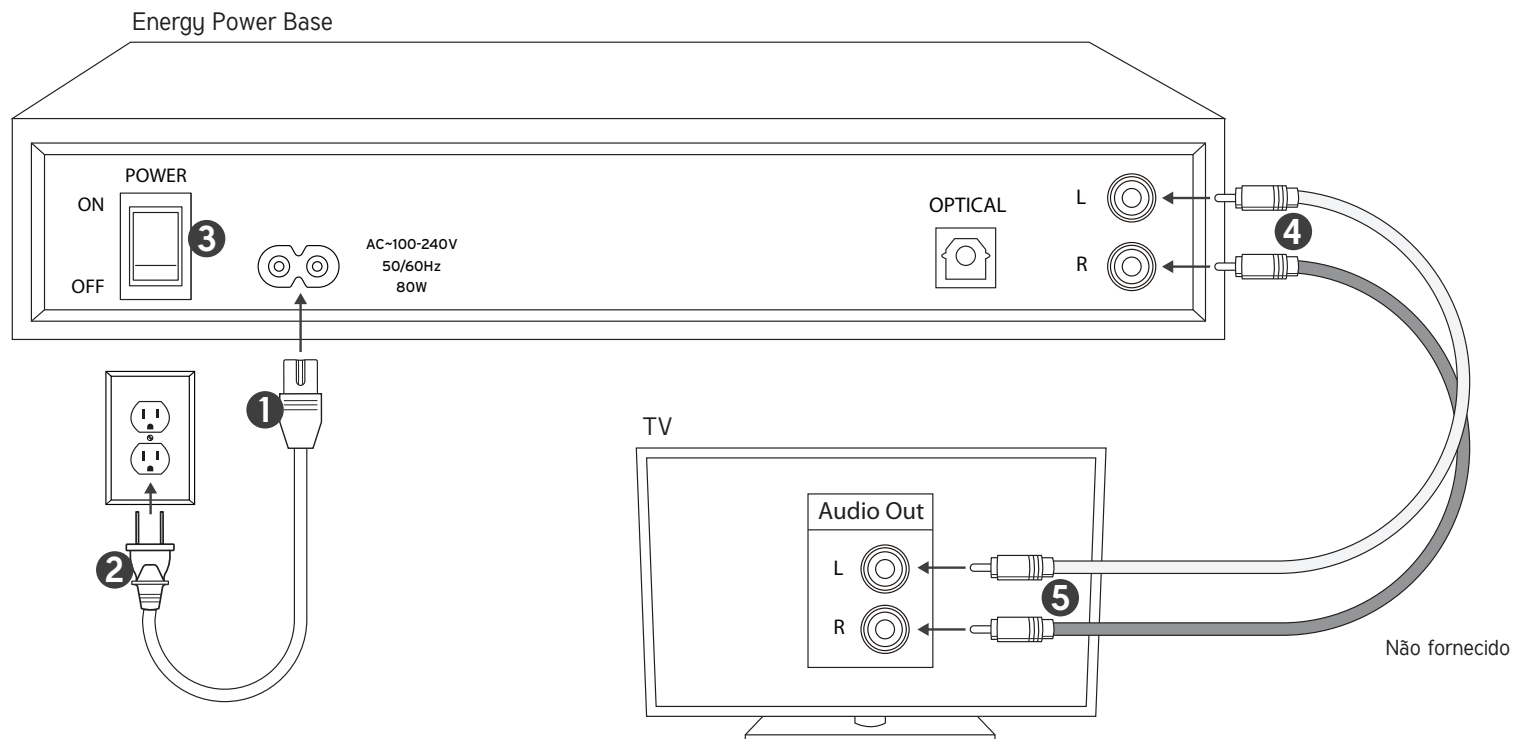

## PROGRAMAÇÃO DO CONTROLE REMOTO DA TV

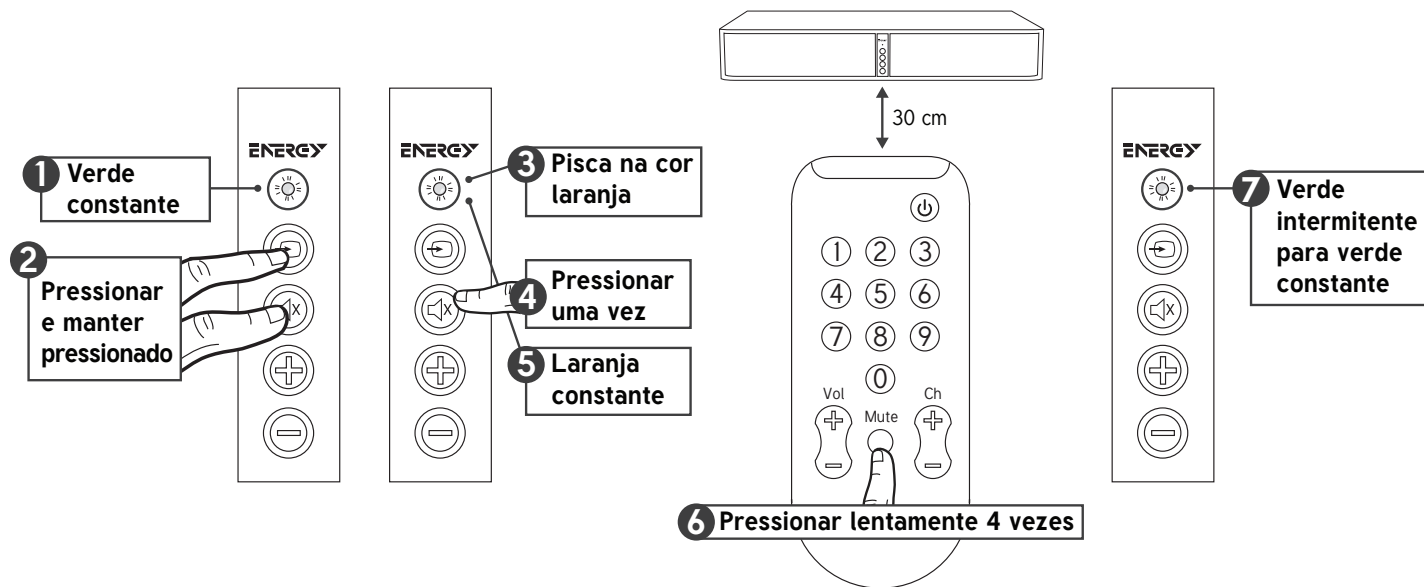

Para programar os botões de aumentar/diminuir o volume, repita os passos indicados e substitua as etapas 4 e 6 com o botão que deseja programar.

Se não estiver tendo sucesso em programar o controle remoto de um receptor de TV a cabo/satélite ou outro controle remoto universal, tente programar o controle remoto da TV ou do receptor de sinal a cabo.

## TECNOLOGIA SEM FIO *BLUETOOTH*<sup>®</sup>

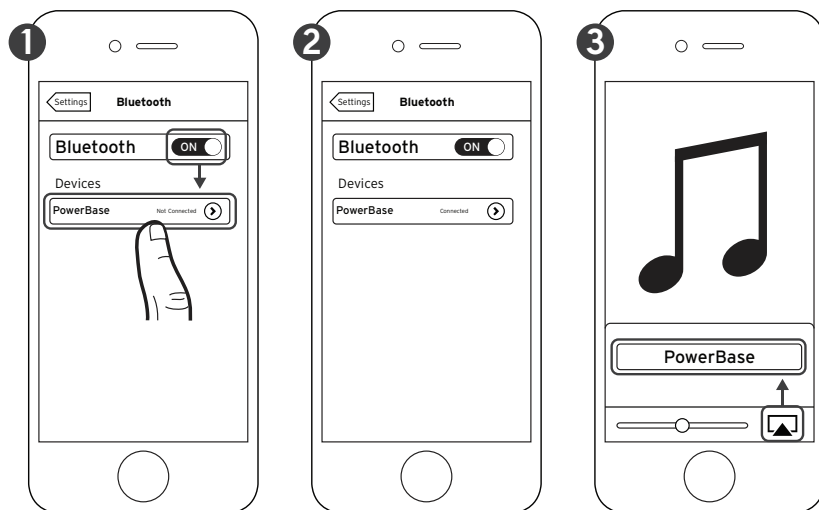

\*Apenas para exemplo. O dispositivo pode ser diferente.

É possível emparelhar um dispositivo *Bluetooth* a qualquer momento ativando o *Bluetooth* no dispositivo.

Depois que o dispositivo *Bluetooth* estiver emparelhado, a Energy Power Base mudará automaticamente para a entrada *Bluetooth* (LUZ AZUL CONSTANTE), o que permitirá a reprodução de músicas. Se a entrada for alterada na Energy Power Base, a conexão *Bluetooth* será automaticamente encerrada.

É necessário desconectar um dispositivo *Bluetooth* antes de emparelhar outro. Para isso:

- Pressione e mantenha pressionado por 3 segundos o botão SOURCE no painel de controle da Energy Power Base
- Desative o *Bluetooth* no dispositivo emparelhado
- Pressione o botão *Bluetooth* no controle remoto da Energy Power Base

# BOTÕES

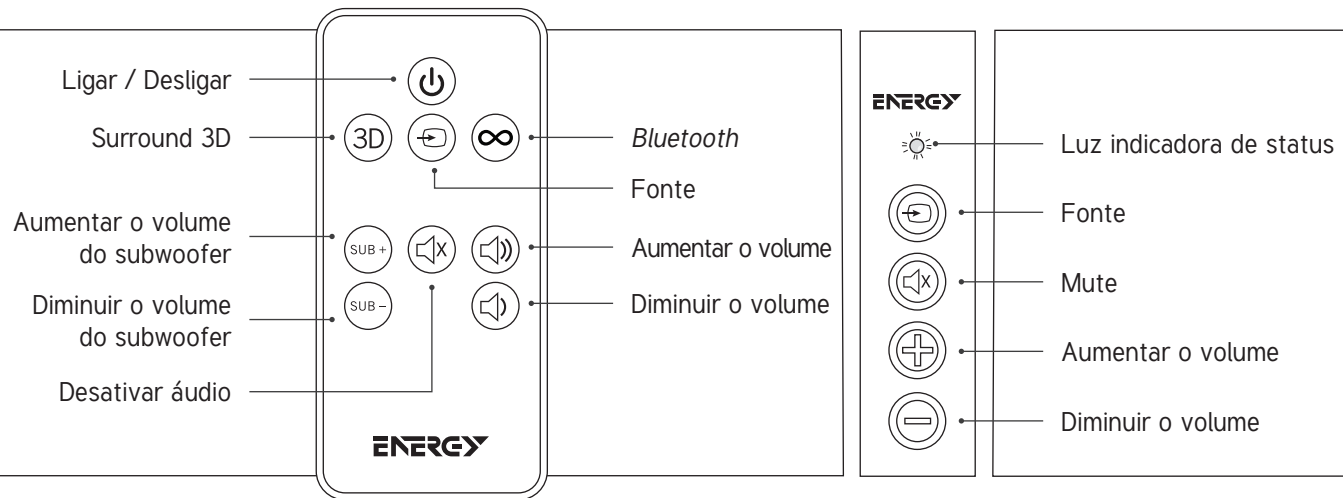

## LUZES INDICADORAS DE STATUS

---

**VERMELHO  
CONSTANTE** Desligado (modo de espera)

**VERDE  
CONSTANTE** Ligado, a fonte é a entrada ótica

**LARANJA  
CONSTANTE** Ligado, a fonte é a entrada analógica

**AZUL  
CONSTANTE** Ligado, a fonte é o dispositivo *Bluetooth* emparelhado

**PISCA EM VERDE /  
LARANJA / AZUL** Botão de aumentar o volume, diminuir o volume, aumentar o volume do subwoofer ou diminuir o volume do subwoofer pressionado

**PISCA EM VERDE UMA VEZ** Surround 3D ligado

**PISCA EM VERMELHO  
UMA VEZ** Surround 3D desligado

**PISCA RAPIDAMENTE  
EM AZUL** Aguardando emparelhamento com o dispositivo *Bluetooth*

**PISCA LENTAMENTE  
EM ROXO** A Energy Power Base está decodificando o sinal Dolby Digital

## MODO DE ESPERA

---

Não é necessário desligar a Energy Power Base, basta desligar a TV (ou o receptor de satélite/cabo) e a Energy Power Base entrará automaticamente no modo de espera em cerca de 10 minutos.

O modo de espera é identificado por uma luz indicadora de status vermelha no painel frontal. Quando a TV (ou o receptor de satélite/cabo) voltar a ser ligada, a Energy Power Base ligará automaticamente.

## POSICIONAMENTO

A TV deve pesar menos  
de 36 kg (80 lbs)

A base da TV deve ser menor que 58  
cm x 30 cm (23" x 12")

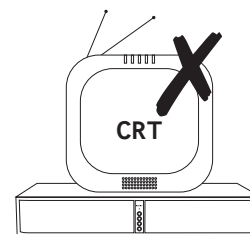
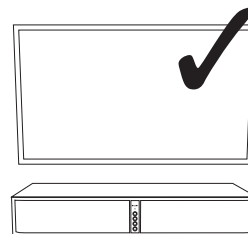
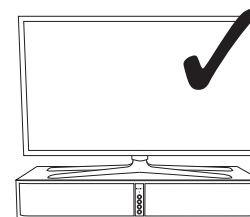
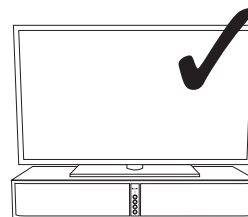
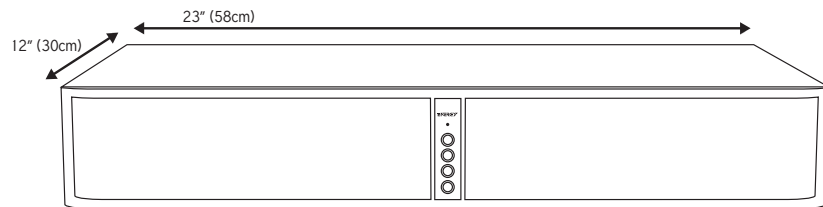

Certifique-se de que a parte traseira da Energy Power Base esteja, no mínimo, a 2,5 cm de distância da parede e que haja pelo menos 2,5 cm de espaço ao redor da parte superior e das laterais da Energy Power Base para ventilação.

## DESLIGUE OS ALTO-FALANTES DA TV

---

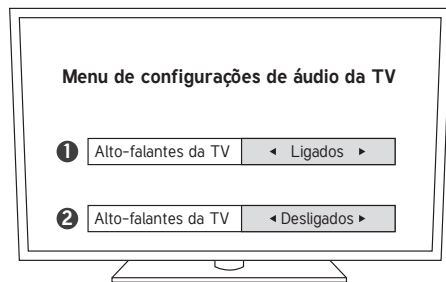

(Recomendado)

OU

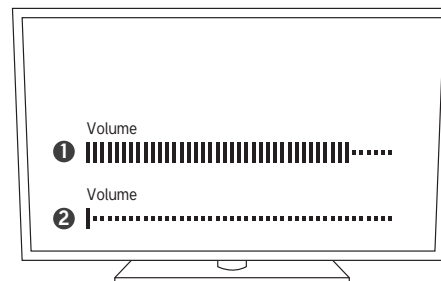

## CUIDADOS E LIMPEZA

---

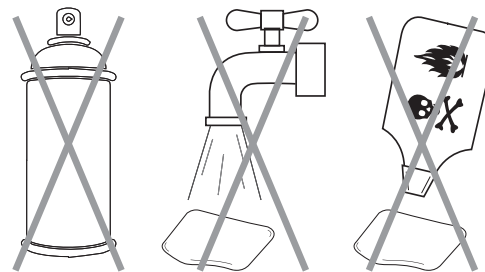
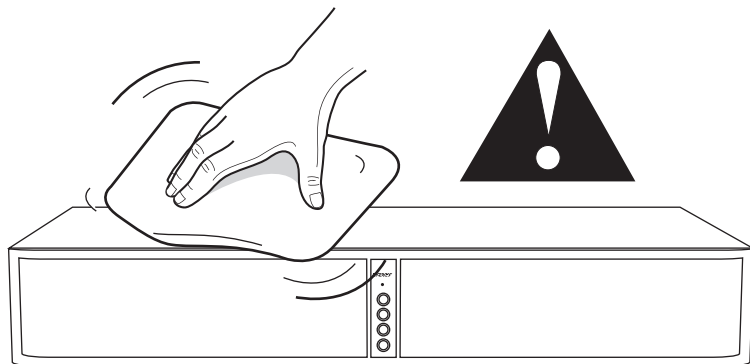

## SOLUÇÃO DE PROBLEMAS

---

### A Energy Power Base não liga

- A unidade está ligada em uma tomada “energizada”?
- A chave liga/desliga no painel traseiro está ligada?

### Não há som

- A unidade está ligada em uma tomada “energizada” e a chave liga/desliga no painel traseiro está ligada?
- Todos os cabos da TV/receptor de TV a cabo ou satélite estão bem conectados?
- Se o cabo ótico estiver sendo utilizado, as coberturas de plástico transparentes foram removidas das duas extremidades antes da conexão?
- O volume está alto?
- O modo de espera está desligado (sem luz indicadora de status VERMELHA CONSTANTE)?
- A fonte de entrada está correta?
- Desligue a chave liga/desliga do painel traseiro e, em seguida, ligue-a novamente.

### Não é possível programar o controle remoto da TV/receptor de TV a cabo/receptor de TV por satélite

- Siga com atenção todas as instruções de programação do controle remoto.
- Faça com atenção a programação do controle remoto novamente, mas use o controle remoto original fornecido com a TV. Assim NÃO é necessário reprogramar o controle remoto universal/do receptor de TV a cabo/satélite.

- Programe as funções da Energy Power Base no controle remoto original da TV (se o original for diferente), em seguida, use o controle remoto universal sem programá-lo.
- Em alguns casos, pode ser necessário repetir a programação de uma ou outra função.
- Pode ser que a Energy Power Base não consiga aprender certos códigos do controle remoto.

### A transmissão por *Bluetooth* não funciona

- O dispositivo *Bluetooth* está emparelhado com a Energy Power Base?
- Aproxime o dispositivo *Bluetooth* da Energy Power Base e certifique-se de que esteja emparelhado.
- Se a luz indicadora de status piscar na cor VERMELHA durante a tentativa de emparelhamento, reinicie o processo de emparelhamento.

*Em caso de dúvidas, entre em contato com o Serviço de Atendimento ao Cliente da Energy:*

*Nos Estados Unidos: 1-866-441-8208*



*Fabricado sob licença da Dolby Laboratories. Dolby e o símbolo do D duplo são marcas registradas da Dolby Laboratories.*

*A marca e os logotipos com a palavra Bluetooth® são marcas comerciais registradas de propriedade da Bluetooth SIG, Inc. e qualquer uso de tais marcas pela Klipsch Group, Inc. é feito mediante licença.*





## 产品组件

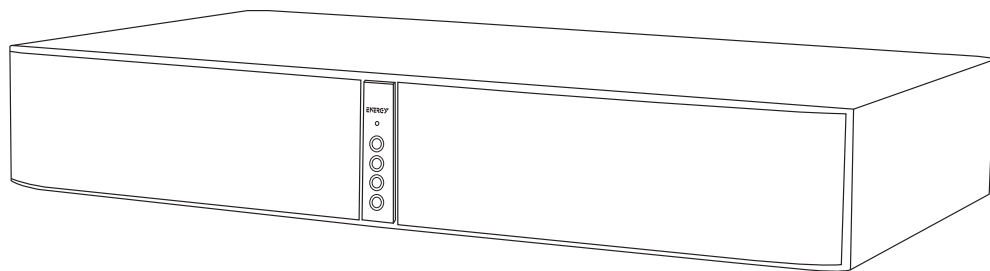

Energy Power® Base



遥控器

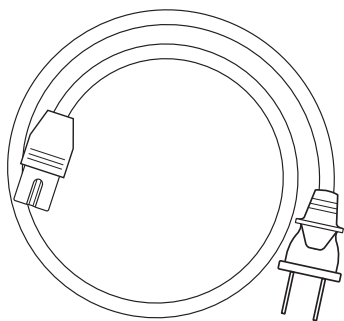

交流电源线

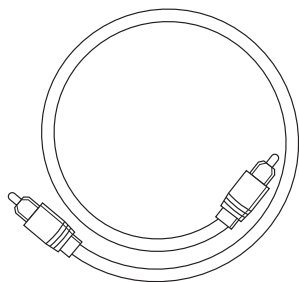

数字光纤电缆

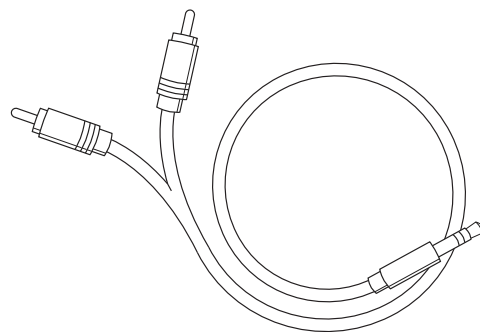

3.5mm 转双 RCA 电缆

## 数字光纤连接（首选，如果电视机不带光纤输出端口，请参见下一页）

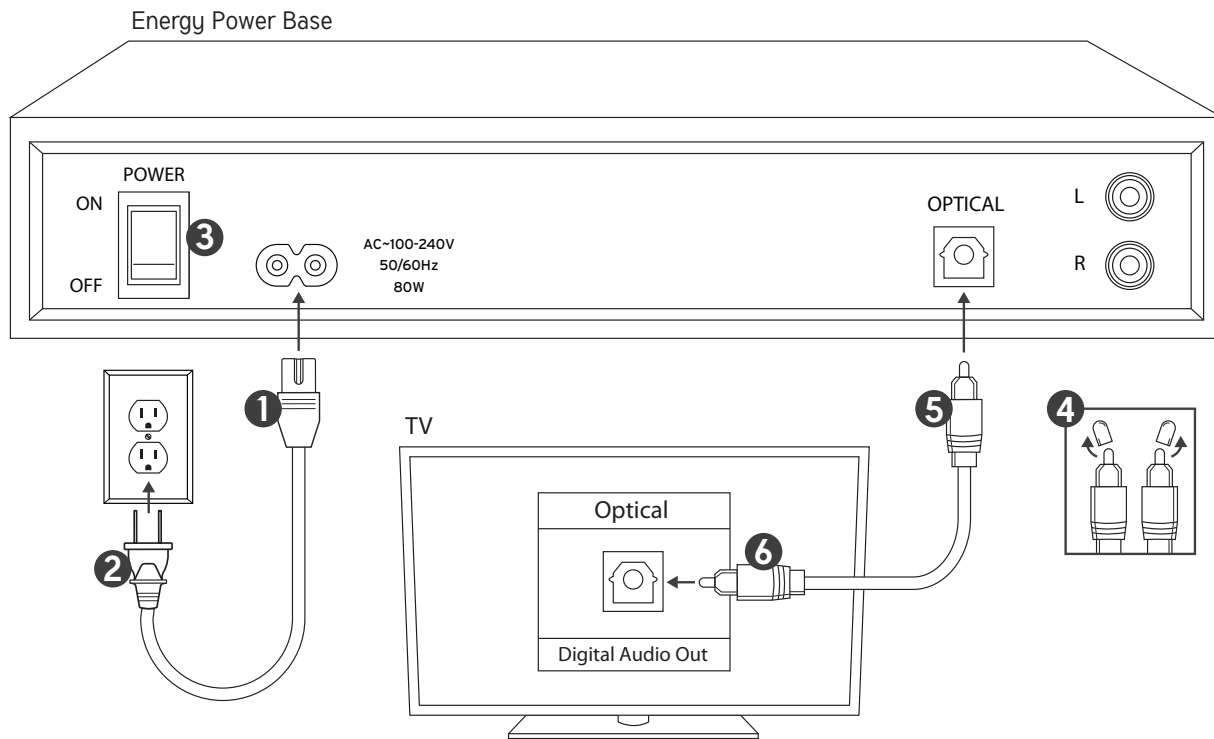

### 3.5MM 转双 RCA 模拟连接（如果电视机不带耳机输出端口，请参见下一页）

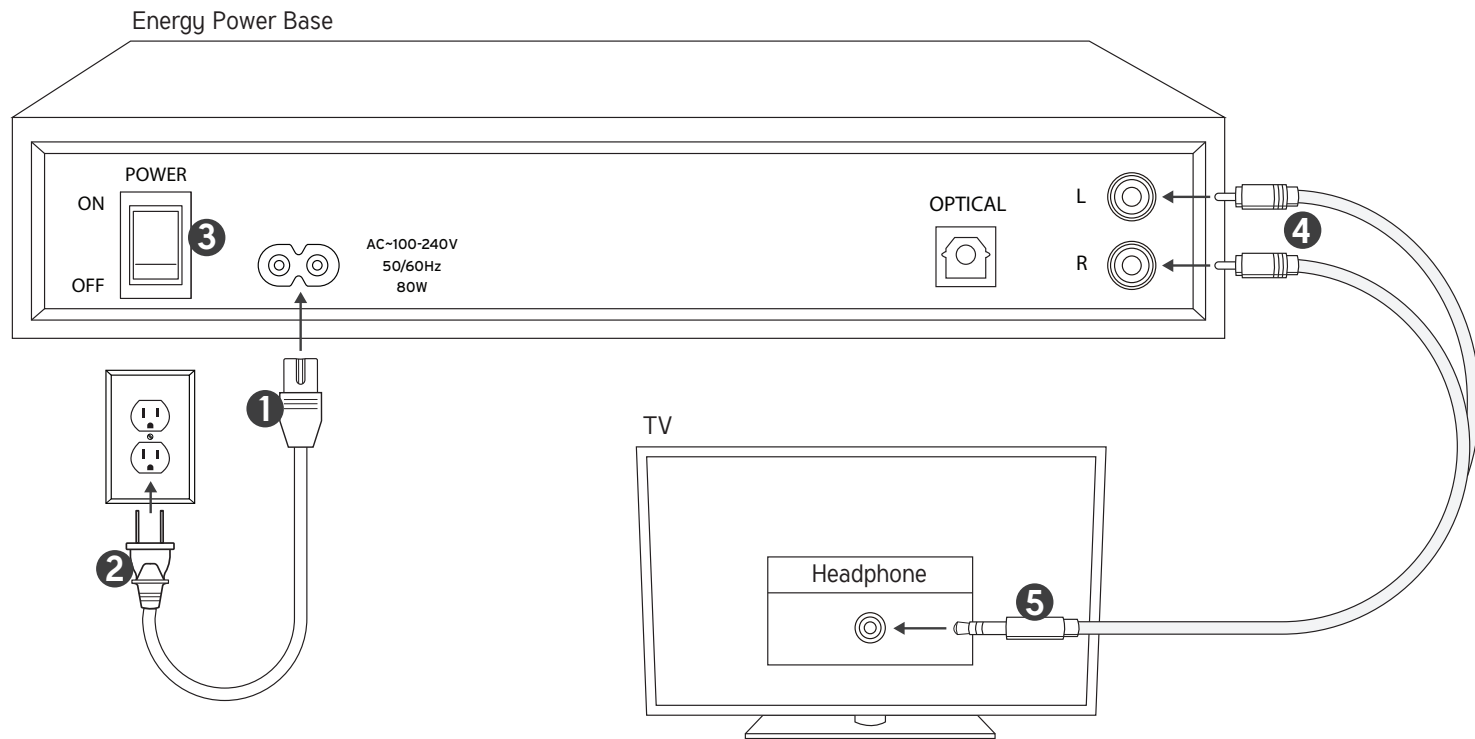

## 双 RCA 转双 RCA 模拟连接

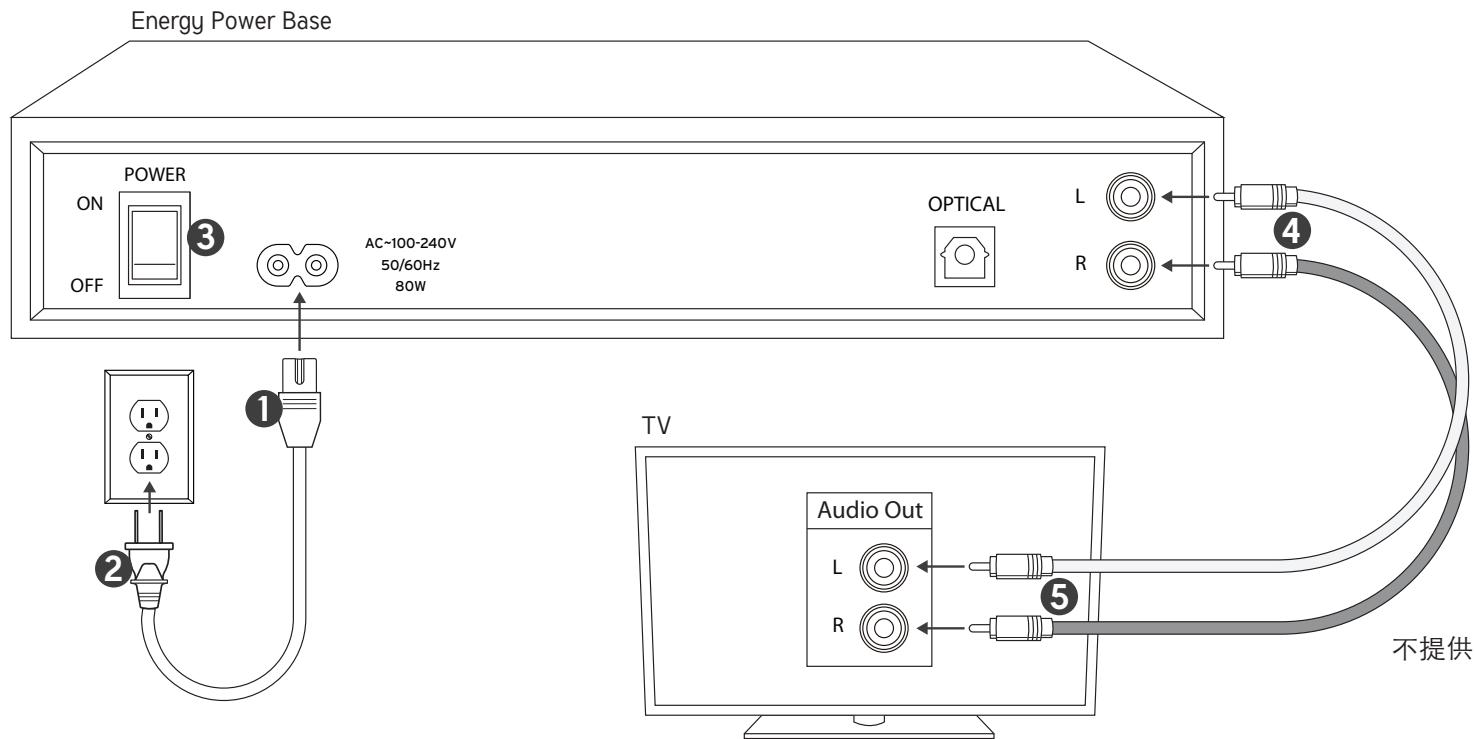

## 电视机遥控器编程

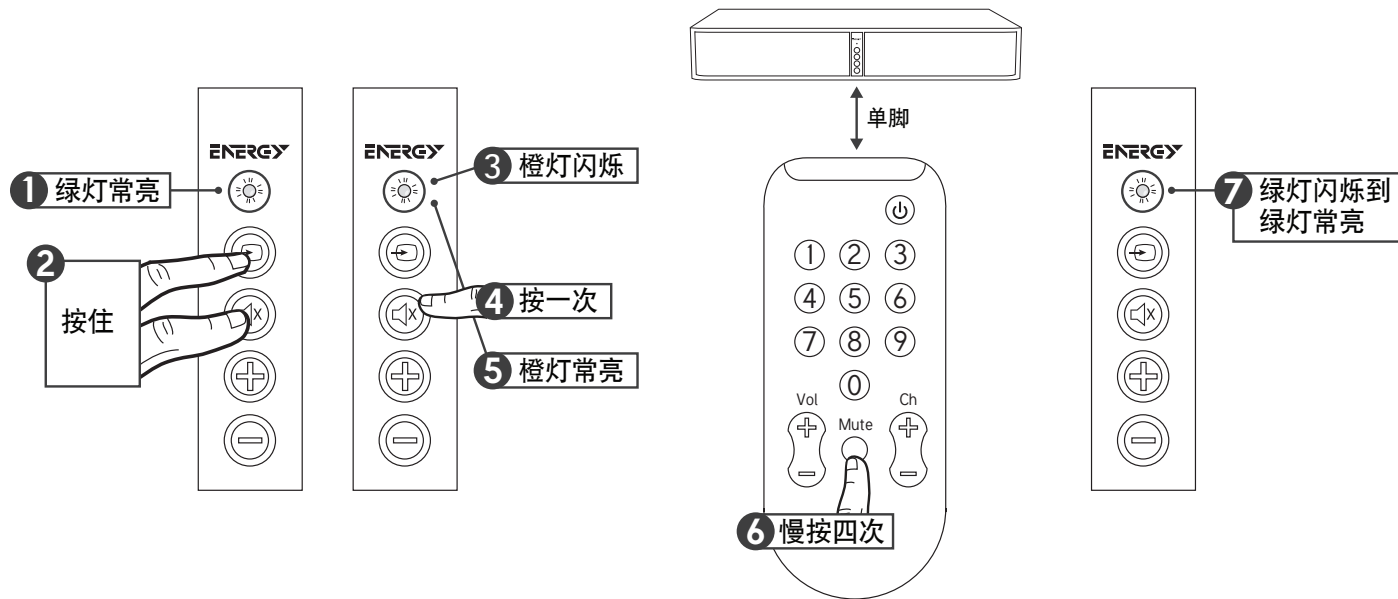

要对音量增大和音量减小按钮编程，请重复以上步骤，并将第 4 步和第 6 步中按下的按钮替换为要编程的按钮。

如果对有线/卫星电视机顶盒遥控器或其它通用遥控器的编程失败，请尝试对电视遥控器或有线电视电视机顶盒遥控器进行编程。

## 蓝牙无线技术

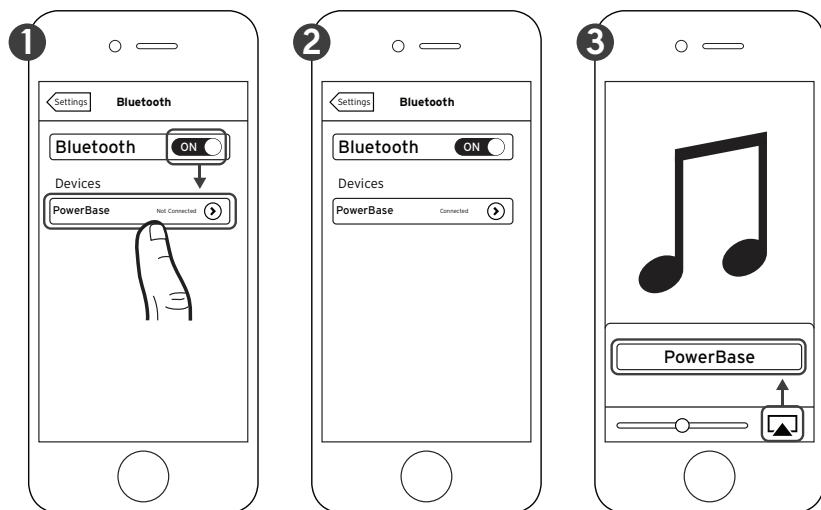

\*仅为示例。实际设备可能有所不同

可随时激活蓝牙设备上的蓝牙功能与 Energy Power Base 配对。

蓝牙设备配对后，Energy Power Base 将自动切换至蓝牙输入（蓝灯常亮），此时可向 Energy Power Base 发送音乐。在 Energy Power Base 上切换输入模式时，蓝牙连接会自动中断。

要与另一蓝牙设备配对，必须先断开当前配对的蓝牙设备。可通过以下任一方法断开蓝牙设备：

- 按住 Energy Power 底座控制面板上的“-SOURCE (来源)”按钮 3 秒钟
- 关闭已配对设备的蓝牙功能
- 按下 Energy Power 底座遥控器上的蓝牙按钮

# 按钮

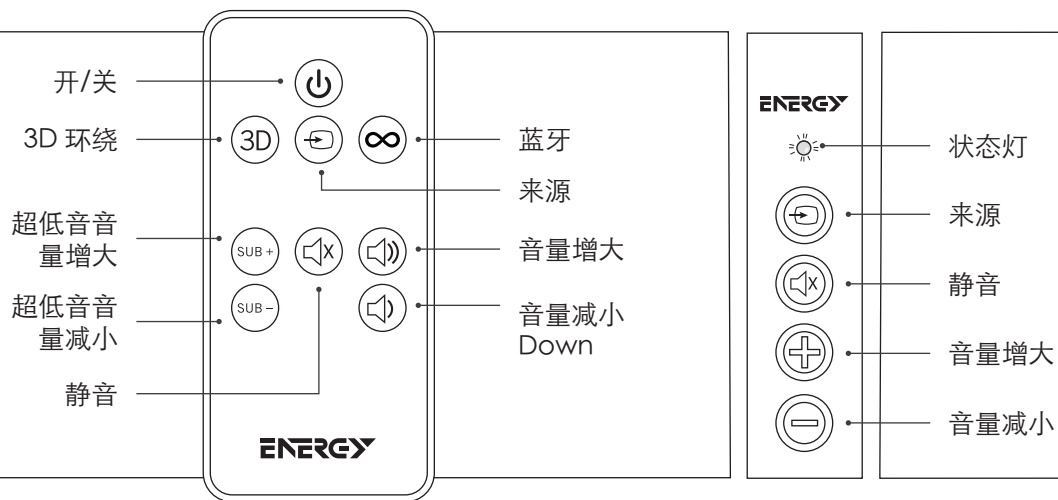



## 状态灯

---

红灯常亮 关机（待机模式）

绿灯常亮 开机，来源为光纤输入

橙灯常亮 开机，来源为模拟输入

蓝灯常亮 开机，来源为配对的蓝牙设备

绿/橙/蓝灯闪烁：音量增大、音量减小或超低音  
音量增大/减小按钮已按下

绿灯闪烁一次 3D 环绕已开启

红灯闪烁一次 3D 环绕已关闭

蓝灯快闪 等待与蓝牙设备配对

紫灯慢闪 Energy Power 底座正在解码杜比数字音频

## 待机模式

---

无需关闭 Energy Power 底座，关闭电视机（或卫星/有线电视顶盒）约 10 分钟后，Energy Power 底座将自动进入待机模式。

前面板的红色状态灯指示待机状态。再次打开电视机（或卫星/有线电视顶盒）时，Energy Power 底座将再次自动启动。

## 放置

电视机的重量应小于 80 英磅 (36kg)

电视机底座应小于 23英寸 x 12英寸  
(58cm x 30cm)

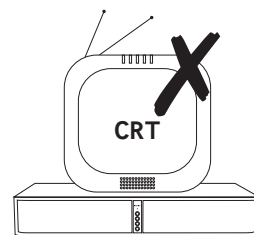
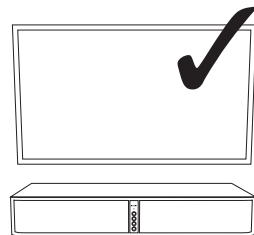
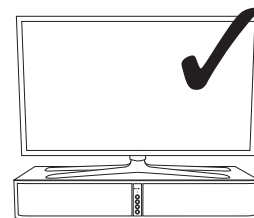
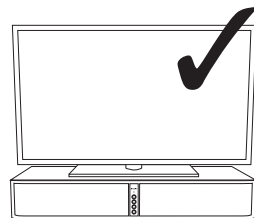
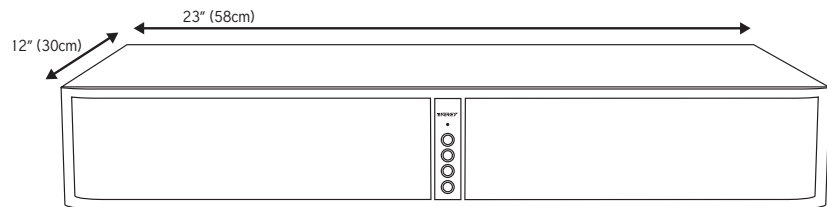

请确保 Energy Power 底座的后部距墙至少一英寸，其顶部和侧面也应保留至少一英寸的空隙，以便通风。

## 关闭电视机扬声器

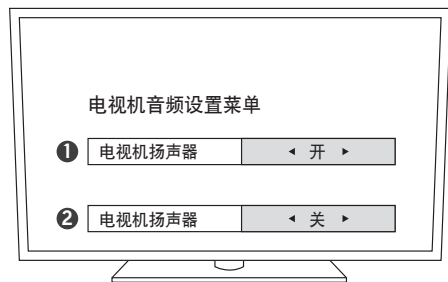

(推荐)

或者

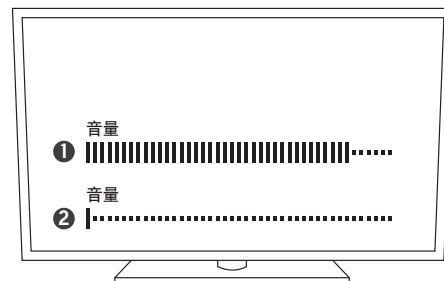

## 保养与清洁

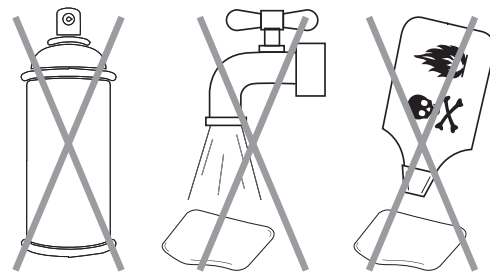
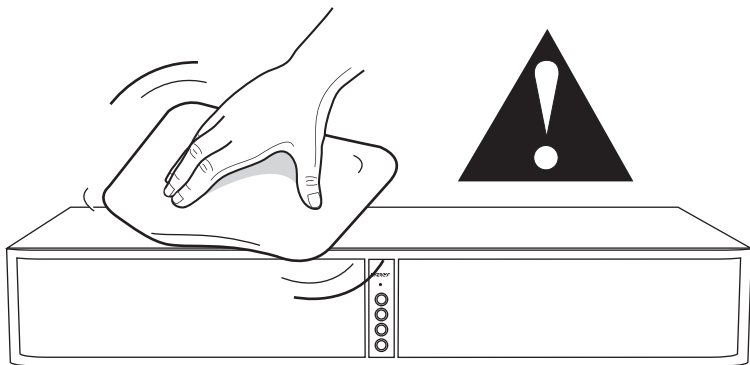

## 故障排除

---

### Energy Power 底座无法开机

- 是否连接了通电的电源插座？
- 后部的电源开关是否打开？

### 没有声音

- 是否连接了通电的电源插座，后部的电源开关是否打开？
- 是否电视机/有线电视机电顶盒/卫星电视机顶盒的所有引出线都已插牢？
- 如果使用光纤，光纤两端的透明塑料帽在连接前是否已取下？
- 音量是否已调高？
- 是否关闭了待机模式（状态灯不是红色常亮）？
- 输入源是否正确？
- 关闭并打开后部的电源开关。

### 无法对电视机/有线电视机电顶盒/卫星电视机顶盒遥控器编程

- 严格遵循所有遥控器编程说明。
- 使用电视机原装的遥控器再次进行遥控编程。无需使用有线电视/卫星电视/通用遥控器再次编程。
- 对电视机原装的遥控器编程，并同步至 Energy Power 底座（如果原装遥控器为另一遥控器），再使用通用遥控器但不需要编程。
- 有些情况下，须重复对某一功能编程。
- 有些情况下，Energy Power 底座无法学到特定的远程代码。

### 蓝牙流媒体功能不正常

- 蓝牙设备是否已与 Energy Power 底座配对？
- 让蓝牙设备靠近 Energy Power 底座，确认设备已配对。
- 如果配对时状态灯闪烁红光，请重新开始配对。

如有疑问，请联系 Energy 客户服务中心：

美国：1-866-441-8208



杜比实验室授权制造。Dolby 和双 D 标志为杜比实验室的注册商标。

Bluetooth® 文字商标和徽标为 Bluetooth SIG, Inc. 的注册商标，Klipsch Group, Inc. 对该商标的使用均得到授权。









---

**[energyspeakers.com](http://energyspeakers.com)**

Register your Energy speaker at [energyspeakers.com/register](http://energyspeakers.com/register).  
3502 Woodview Trace Indianapolis, IN 46268 • 866.441.8208

Energy, Energy Power and the Energy logo are registered trademarks of Audio Products International Corp., registered in the U.S. and other countries. Audio Products International Corp. is a wholly owned subsidiary of Vox International Corporation.